

Presta™

Quick Reference Guide

Model BLMPR



FOR THE LOVE OF SEWING

To register your machine warranty and receive Baby Lock product updates and offers, go to babylock.com/profile. If you have questions with registration, visit your Authorized Baby Lock Retailer.

Baby Lock Consumer Helpline: 800-313-4110

www.babylock.com

Before using your machine for the first time please read the “IMPORTANT SAFETY INSTRUCTIONS” in the Instruction and Reference Guide.

Refer to the instruction and reference guide for detailed instructions.

Antes de utilizar la máquina por primera vez, lea las “INSTRUCCIONES DE SEGURIDAD IMPORTANTES” en la Guía de referencia y de instrucciones.

Consulte las instrucciones detalladas en la guía de referencia y de instrucciones.

Avant d'utiliser votre machine pour la première fois, veuillez lire les « INSTRUCTIONS DE SÉCURITÉ IMPORTANTES » indiquées dans le guide d'instructions et de référence.

Reportez-vous au guide d'instructions et de référence pour des informations détaillées.

Contents

Winding/Installing the Bobbin.....	2
Upper Threading	4
Selecting and Sewing Patterns	6
◆ Preset Utility Stitches	6
◆ Utility Stitches	7
◆ Decorative Stitches.....	8
◆ Character stitches	8
Summary of Stitch Patterns.....	9
◆ Preset Utility Stitches	9
◆ Utility Stitches	9
◆ Decorative Stitches	9
◆ Character Stitches	10

Contenido

Devanar/colocar la bobina	2
Hilo superior	4
Seleccionar y coser patrones	6
◆ Puntadas de utilidad predefinidas	6
◆ Puntadas de utilidad	7
◆ Puntadas decorativas	8
◆ Puntadas de carácter	8
Resumen de tipos de puntada	9
◆ Puntadas de utilidad predefinidas	9
◆ Puntadas de utilidad	9
◆ Puntadas decorativas	9
◆ Puntadas de carácter	10

Table des matières

Bobinage/installation de la canette.....	2
Enfilage supérieur	4
Sélection et couture de motifs	6
◆ Préréglage des points de couture courants	6
◆ Points de couture courants	7
◆ Points décoratifs	8
◆ Points de caractères.....	8
Sommaire des motifs de point.....	9
◆ Préréglage des points de couture courants	9
◆ Points de couture courants	9
◆ Points décoratifs	9
◆ Points de caractères	10



Winding/Installing the Bobbin

Devanar/colocar la bobina

Bobinage/installation de la canette

Follow the steps below, in numerical order. Refer to the instruction and reference guide for detailed instructions.
 Siga los pasos descritos a continuación, en orden numérico. Consulte las instrucciones detalladas en la guía de referencia y de instrucciones.
 Respectez les étapes ci-dessous, dans l'ordre numérique. Reportez-vous au guide d'instructions et de référence pour des informations détaillées.

Use only the included bobbin or bobbins of the same type.
 Utilice solo la bobina incluida, o bobinas del mismo tipo.
 N'utilisez que la canette fournie ou des canettes du même type.

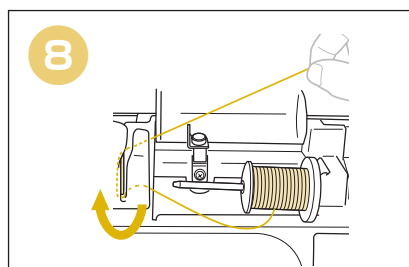
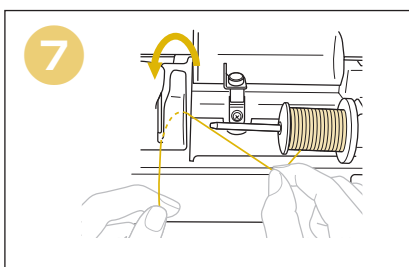
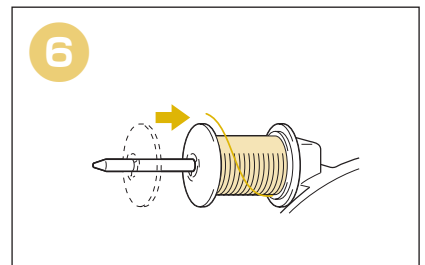
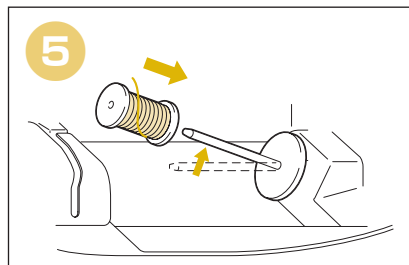
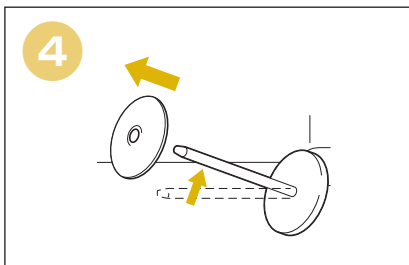
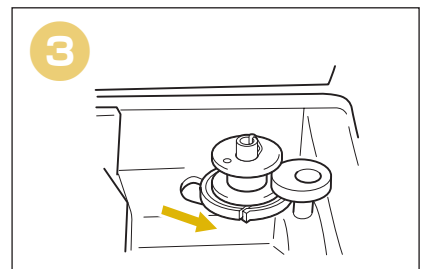
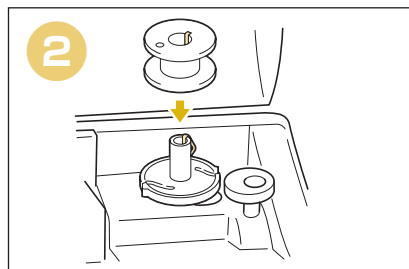
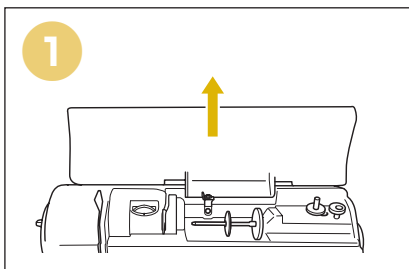
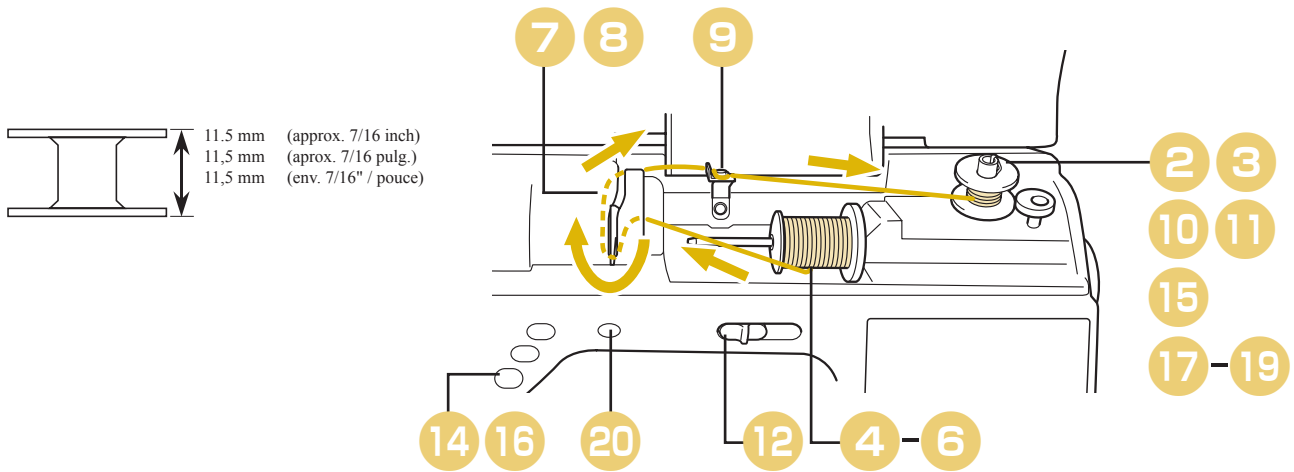

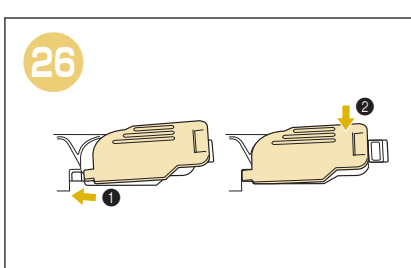
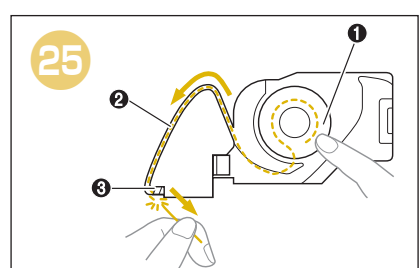
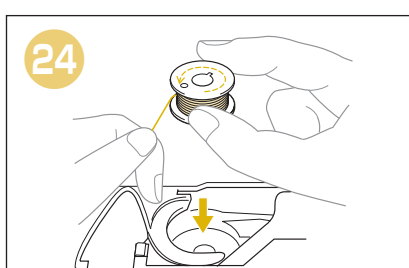
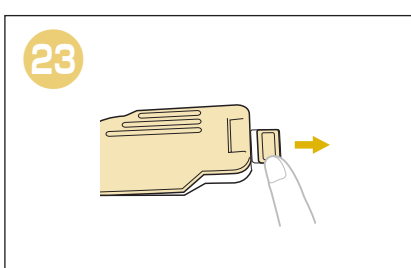
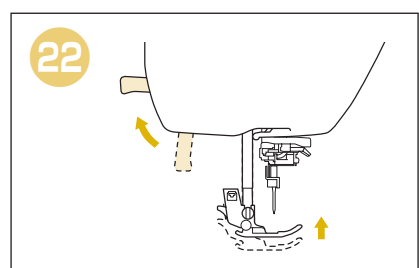
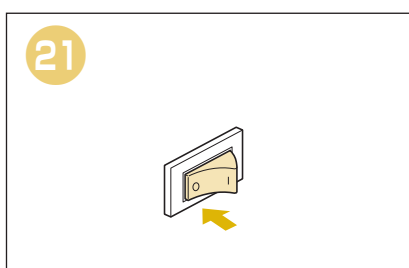
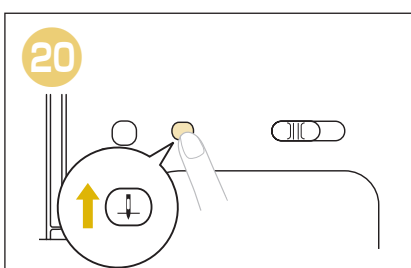
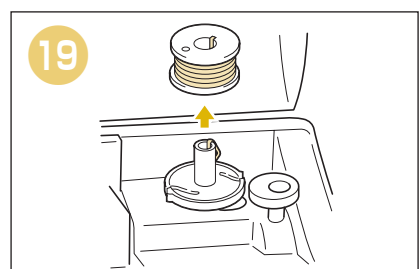
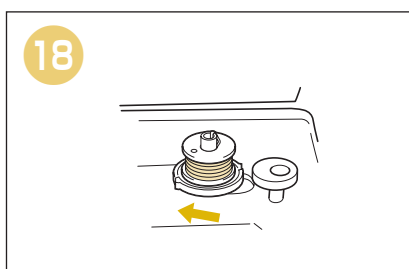
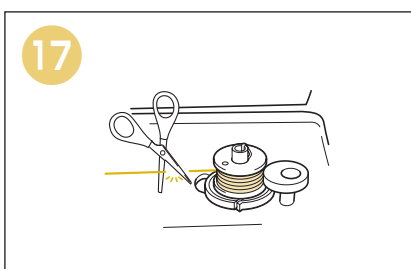
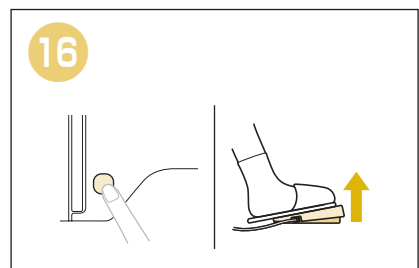
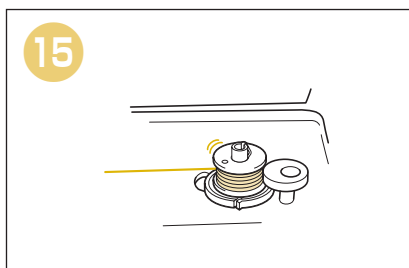
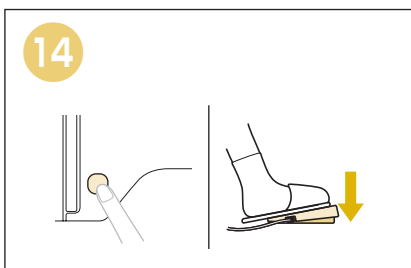
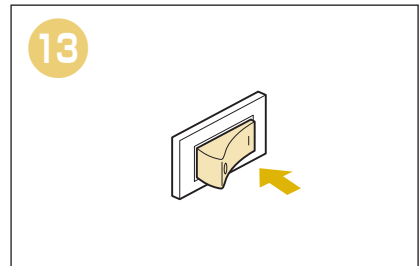
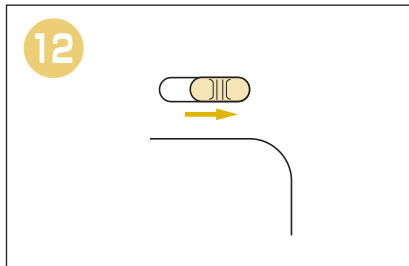
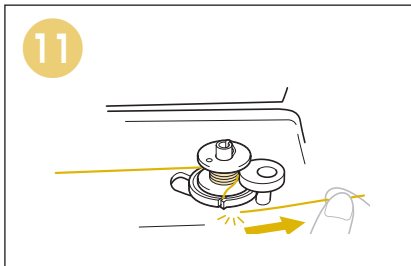
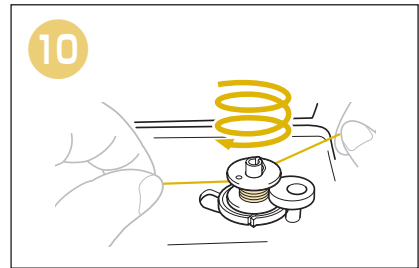
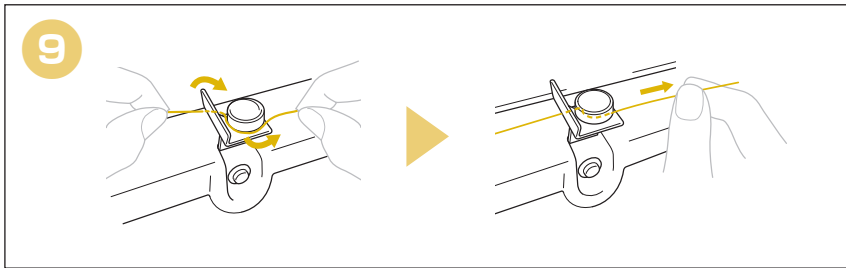



Upper Threading Hilo superior Enfilage supérieur

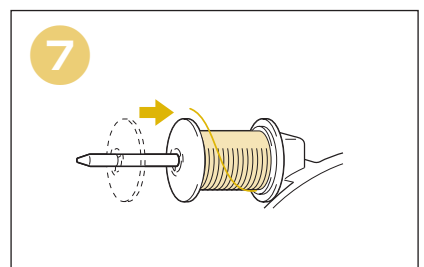
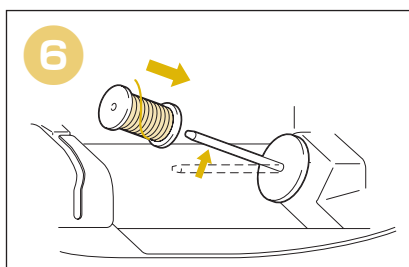
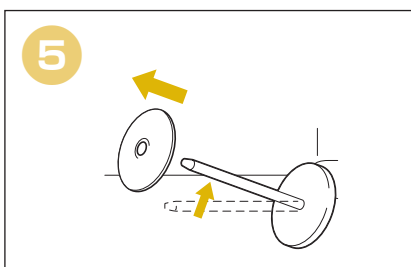
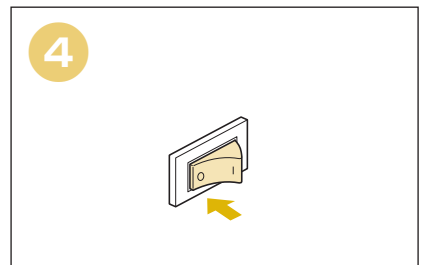
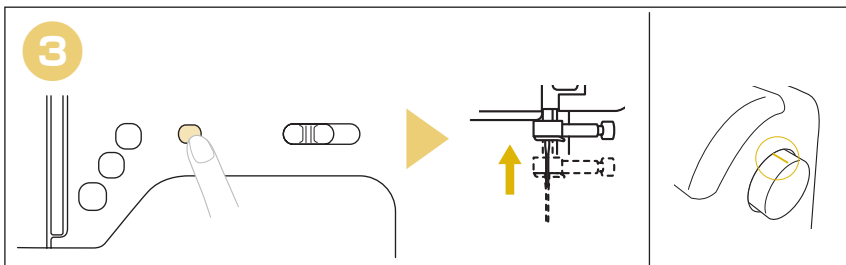
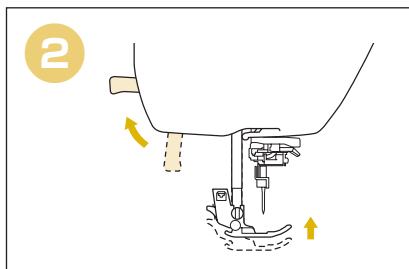
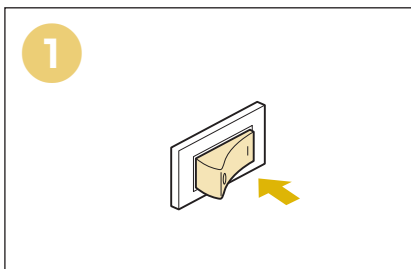
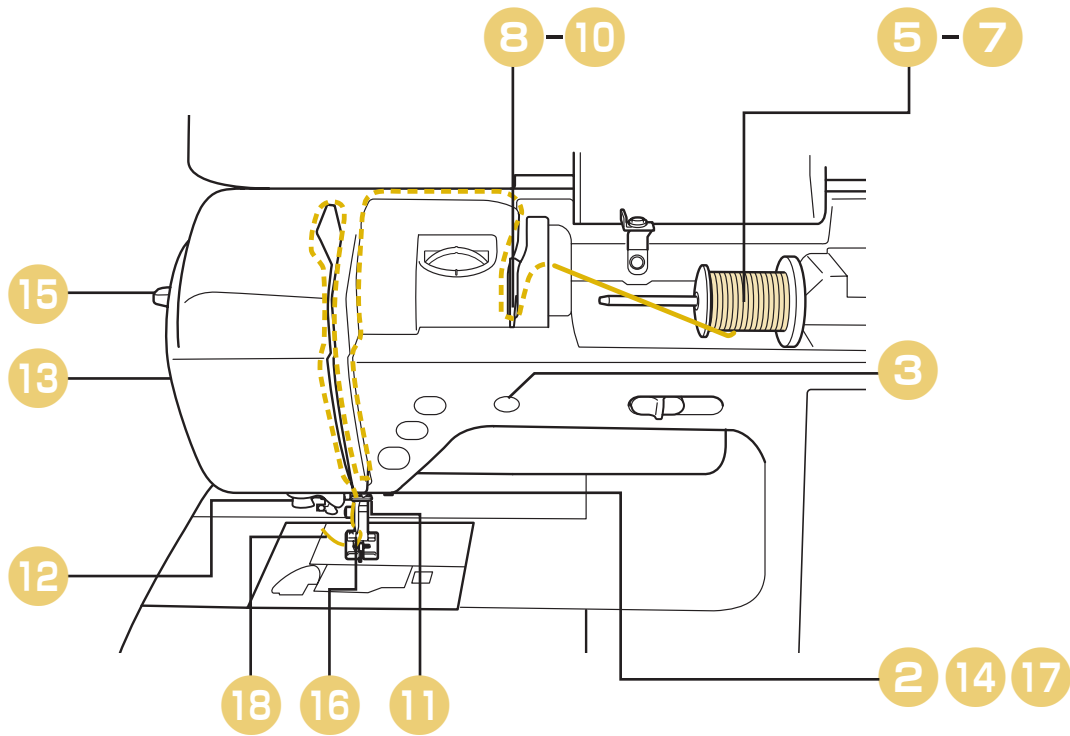

Selecting and Sewing Patterns

Seleccionar y coser patrones

Sélection et couture de motifs

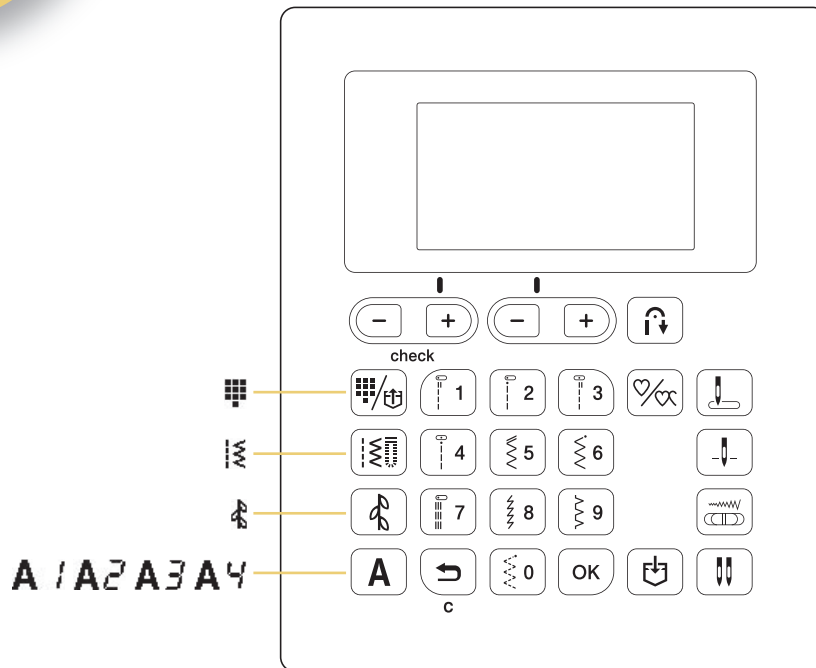

◆ Preset Utility Stitches ◆ Puntadas de utilidad predefinidas ◆ Préréglage des points de couture courants

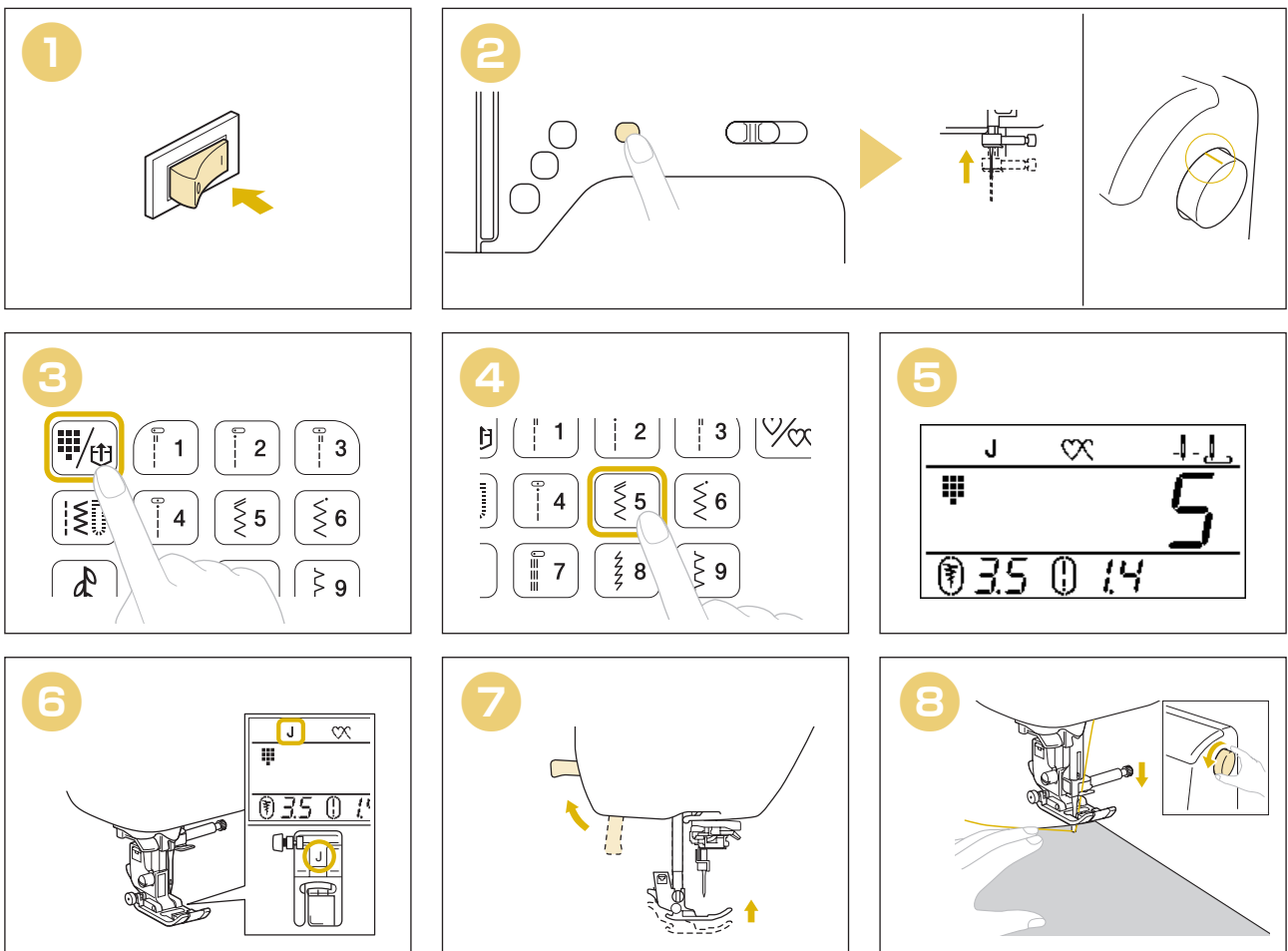
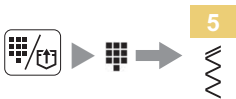

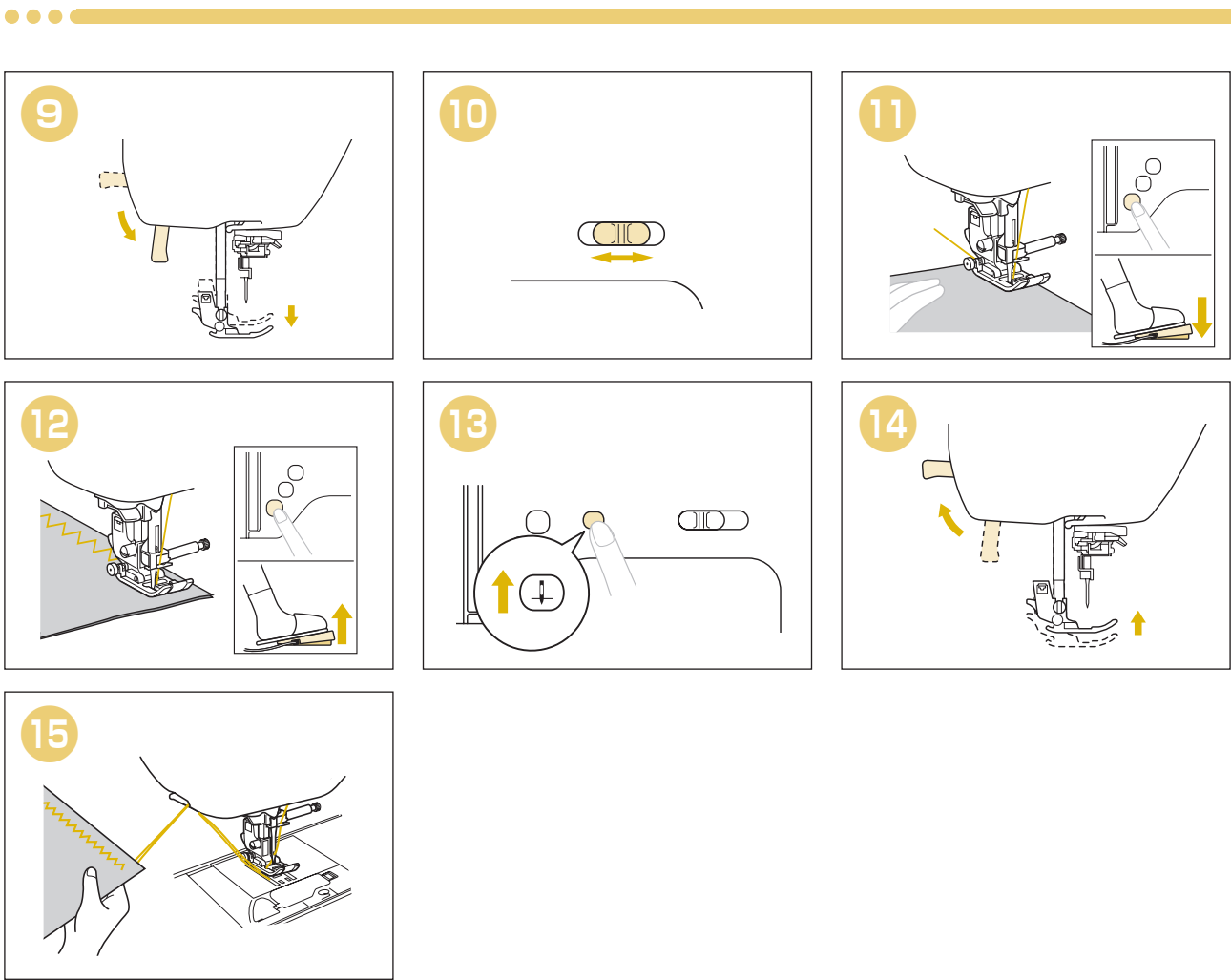

◆ Utility Stitches ◆ Puntadas de utilidad ◆ Points de couture courants

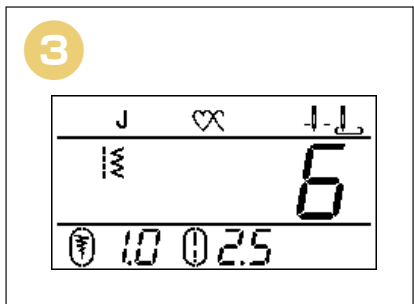
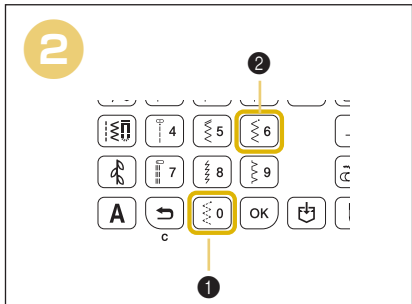
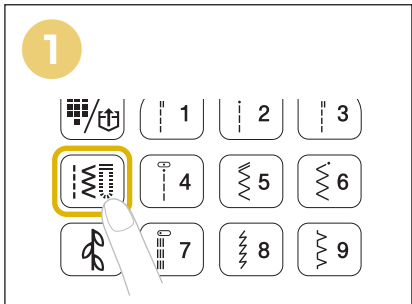
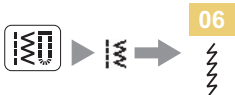

◆ Decorative Stitches ◆ Puntadas decorativas ◆ Points décoratifs

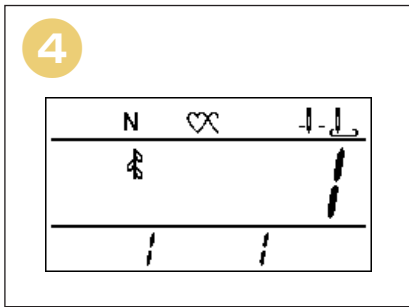
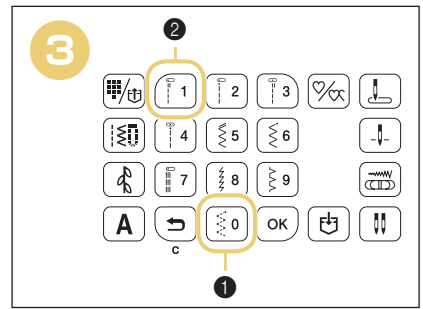
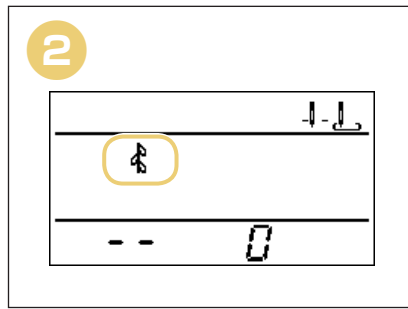
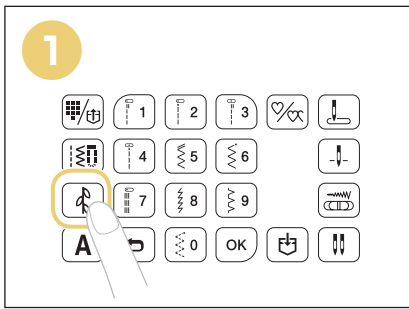

◆ Character stitches ◆ Puntadas de carácter ◆ Points de caractères

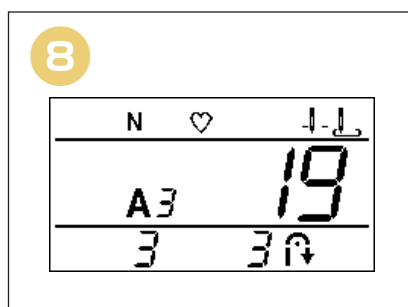
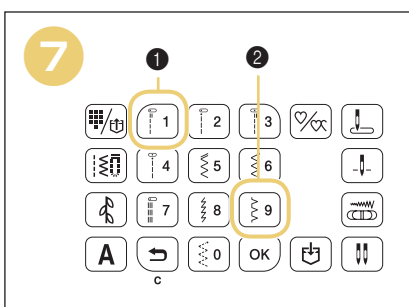
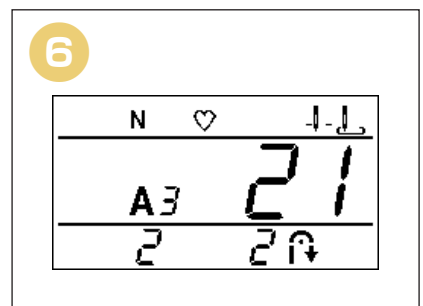
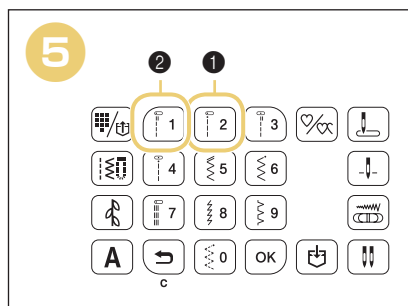
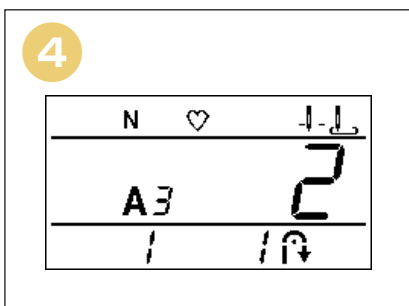
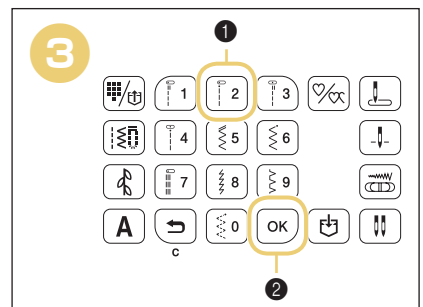
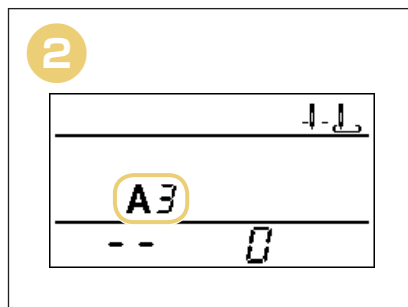
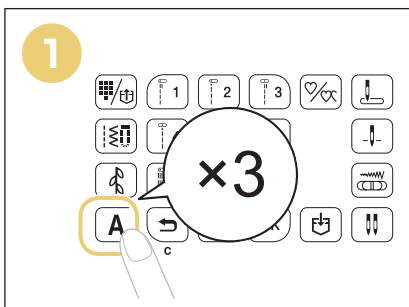

Summary of Stitch Patterns

Resumen de tipos de puntada

Sommaire des motifs de point



◆ Preset Utility Stitches ◆ Puntadas de utilidad predefinidas ◆ Préréglage des points de couture courants



◆ Utility Stitches ◆ Puntadas de utilidad ◆ Points de couture courants

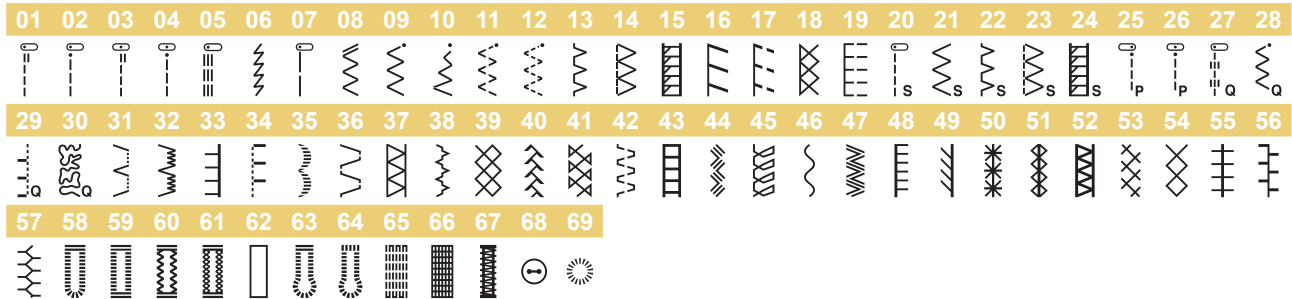

◆ Decorative Stitches ◆ Puntadas decorativas ◆ Points décoratifs



● Decorative Stitches (01-19)
Satin stitches (20-24)
7 mm satin stitches (25-29)
Cross stitch stitches (30,31)

● Puntadas decorativas (01-19)
Costuras para satén (20-24)
Puntadas satinadas de 7 mm (25-29)
Puntadas de punto de cruz (30,31)

● Points décoratifs (01-19)
Points plumetis (20-24)
Points plumetis 7 mm (25-29)
Points de croix (30,31)

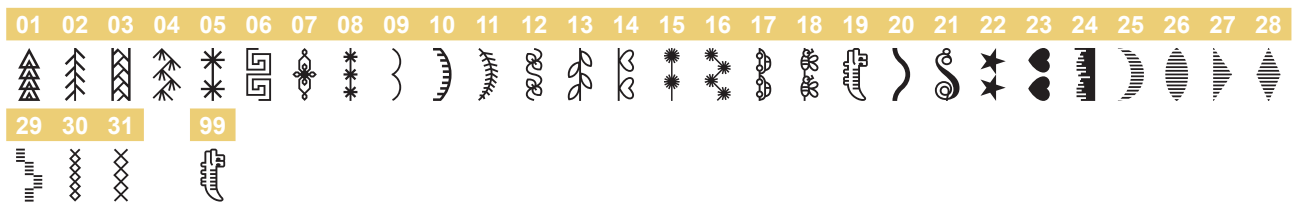

* 99: Pattern for making alignment adjustments

* 99: Patrón para hacer el ajuste

* 99: Motif d'ajustement

◆ Character Stitches ◆ Puntadas de carácter ◆ Points de caractères

A ×1 ▶ **A** !

● Gothic font

● Fuente gótica

● Police gothique

1	2	3	4	5	6	7	8	9	10	11	12	13	14	15	16	17	18	19	20	21	22	23	24	25	26
A	B	C	D	E	F	G	H	I	J	K	L	M	N	O	P	Q	R	S	T	U	V	W	X	Y	Z
27	28	29	30	31	32	33	34	35	36	37	38	39	40	41	42	43	44	45	46	47	48	49	50	51	52
0	1	2	3	4	5	6	7	8	9	#	%	-	+	X	÷	=	*	.	,	&	?	!	@	<	>
53	54	55	56	57	58	59	60	61	62	63	64	65	66	67	68	69	70	71	72	73	74	75	76	77	78
()	[]	/	\	~	©	®	™	“	”	”	’	’	’	’	’	’	’	’	’	’	’	’	’
79	80																								
Ü	ß																								

A ×2 ▶ **A** ?

● Handwriting font

● Fuente de escritura a mano

● Police manuscrite

1	2	3	4	5	6	7	8	9	10	11	12	13	14	15	16	17	18	19	20	21	22	23	24	25	26
A	B	C	D	E	F	G	H	I	J	K	L	M	N	O	P	Q	R	S	T	U	V	W	X	Y	Z
27	28	29	30	31	32	33	34	35	36	37	38	39	40	41	42	43	44	45	46	47	48	49	50	51	52
0	1	2	3	4	5	6	7	8	9	#	%	-	+	X	÷	=	*	.	,	&	?	!	@	<	>
53	54	55	56	57	58	59	60	61	62	63	64	65	66	67	68	69	70	71	72	73	74	75	76	77	78
()	[]	/	\	~	©	®	™	“	”	”	’	’	’	’	’	’	’	’	’	’	’	’	’
79	80																								
Ü	ß																								

A ×3 ▶ **A3**

● Outline

● Con borde

● Contour

1	2	3	4	5	6	7	8	9	10	11	12	13	14	15	16	17	18	19	20	21	22	23	24	25	26
A	B	C	D	E	F	G	H	I	J	K	L	M	N	O	P	Q	R	S	T	U	V	W	X	Y	Z
27	28	29	30	31	32	33	34	35	36	37	38	39	40	41	42	43	44	45	46	47	48	49	50	51	52
0	1	2	3	4	5	6	7	8	9	#	%	-	+	×	÷	=	*	.	,	&	?	!	@	<	>
53	54	55	56	57	58	59	60	61	62	63	64	65	66	67	68	69	70	71	72	73	74	75	76	77	78
()	[]	/	\	~	©	®	™	“	”	”	”	”	”	”	”	”	”	”	”	”	”	”	”
79	80																								
U	U																								

A ×4 ▶ **A4**

● Japanese font

● Fuente japonesa

● Police japonaise

1	2	3	4	5	6	7	8	9	10	11	12	13	14	15	16	17	18	19	20	21	22	23	24	25	26
あ	い	う	え	お	あ	い	う	え	お	か	き	く	け	こ	が	ぎ	ぐ	げ	ご	さ	し	す	せ	そ	ざ
27	28	29	30	31	32	33	34	35	36	37	38	39	40	41	42	43	44	45	46	47	48	49	50	51	52
じ	ず	ぜ	ぞ	た	ち	つ	て	と	だ	ぢ	づ	で	ど	っ	な	に	ぬ	ね	の	は	ひ	ふ	へ	ほ	ば
53	54	55	56	57	58	59	60	61	62	63	64	65	66	67	68	69	70	71	72	73	74	75	76	77	78
び	ぶ	べ	ぼ	ぱ	ぴ	ぷ	ぺ	ぽ	ま	み	む	め	も	や	ゆ	よ	ゃ	ゅ	ょ	ら	り	る	れ	ろ	わ
79	80	81	82	83	84	85	86	87	88	89	90	91	92	93	94	95	96	97	98	99	100	101	102	103	104
を	ん	ア	イ	ウ	エ	オ	ァ	ィ	ゥ	ェ	ォ	ヴ	カ	キ	ク	ケ	コ	ガ	ギ	グ	ゲ	ゴ	サ	シ	ス
105	106	107	108	109	110	111	112	113	114	115	116	117	118	119	120	121	122	123	124	125	126	127	128	129	130
セ	ソ	ザ	ジ	ズ	ゼ	ゾ	タ	チ	ツ	テ	ト	ダ	ヂ	ヅ	ド	ッ	ナ	ニ	ヌ	ネ	ノ	ハ	ヒ	フ	
131	132	133	134	135	136	137	138	139	140	141	142	143	144	145	146	147	148	149	150	151	152	153	154	155	156
へ	ホ	バ	ビ	ブ	ベ	ボ	パ	ピ	プ	ペ	ポ	マ	ミ	ム	メ	モ	ヤ	ユ	ヨ	ャ	ュ	ョ	ラ	リ	ル
157	158	159	160	161	162	163	164	165	166	167	168	169	170	171	172	173	174	175	176	177	178	179	180	181	182
レ	ロ	ワ	ラン	0	1	2	3	4	5	6	7	8	9	〇	一	二	三	四	五	六	七	八	九	十	
183	184	185	186	187	188	189	190	191	192	193	194	195	196	197	198	199	200	201	202	203	204	205	206	207	208
&	?	!	()	-	生	年	月	日	才	保	育	幼	稚	園	小	中	学	校	組	部	火	水	木	金
209	210																								
土	_																								

- Example of Kanji characters in daily life
- Ejemplo de caracteres Kanji en la vida cotidiana
- Exemple de caractères Kanji dans la vie quotidienne

一 二 三 四 五 六 七 八 九 十

1, 2, 3, 4, 5, 6, 7, 8, 9, 10

生 年 月 日

Date of birth

Fecha de nacimiento

Date de naissance

一 才

1 year old

1 año de edad

1 an

保 育 園

Nursery school

Guardería

Crèche

幼 稚 園

Kindergarten

Jardín de infancia

École maternelle

小 学 校

Elementary school

Escuela primaria

École primaire

中 学 校

Junior high school

Escuela secundaria

Collège

組

Group/Class

Grupo/Clase

Groupe/Classe

部

Club/Division

Club/División

Club/Division

月

Moon/Monday

Luna/Lunes

Lune/Lundi

火

Fire/Tuesday

Fuego/Martes

Feu/Mardi

水

Water/Wednesday

Agua/Miércoles

Eau/Mercredi

木

Tree/Thursday

Árbol/Jueves

Arbre/Jeudi

金

Gold/Friday

Oro/Viernes

Or/Vendredi

土

Soil/Saturday

Tierra/Sábado

Terre/Samedi

日

Sun/Sunday

Sol/Domingo

Soleil/Dimanche

一 月 一 日 (月)

January 1st (Monday)

1 de enero (lunes)

1er janvier (lundi)

English
Spanish
French
888-F11
Printed in Vietnam



XG5454-001