

Operation Manual

Embroidery Machine

Product Code: 882-T52

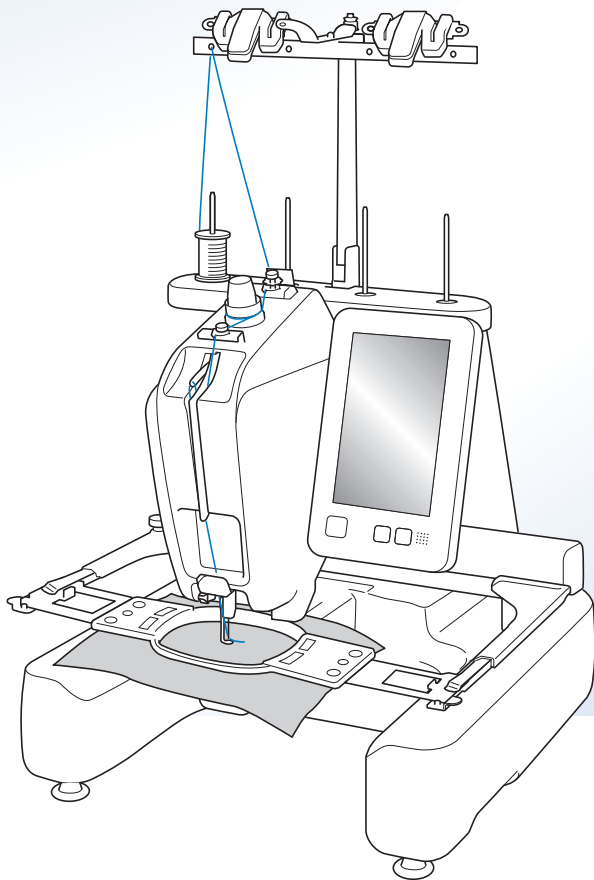

Instruction Videos



<https://s.brother/cvcab/>

Be sure to read this document before using the machine.
We recommend that you keep this document nearby for future reference.
The latest manuals are available at Brother support website (<https://s.brother/cpcab/>).

INTRODUCTION

Thank you for purchasing this machine. Before using this machine, carefully read the "IMPORTANT SAFETY INSTRUCTIONS", and then study this manual for the correct operation of the various functions.

In addition, after you have finished reading this manual, store it where it can quickly be accessed for future reference.

Failure to follow these instructions may result in an increased risk of personal injury or damage to property, including through fire, electrical shock, burns or suffocation.

IMPORTANT SAFETY INSTRUCTIONS

Please read these safety instructions before attempting to use the machine.

DANGER

- To reduce the risk of electric shock

1 Always unplug the machine from the electrical outlet immediately after using, when cleaning, when making any user servicing adjustments mentioned in this manual, or if you are leaving the machine unattended.

WARNING

- To reduce the risk of burns, fire, electric shock, or injury to persons.

2 Always unplug the machine from the electrical outlet when lubricating it or when making any other user servicing adjustments mentioned in the Operation Manual.

- To unplug the machine, switch the machine to the symbol "O" position to turn it off, then grasp the plug and pull it out of the electrical outlet. Do not pull on the cord.
- Plug the machine directly into the electrical outlet. Do not use an extension cord.
- Always unplug your machine if the power is cut.

3 Electrical Hazards:

- This machine should be connected to an AC power source within the range indicated on the rating label. Do not connect it to a DC power source or inverter. If you are not sure what kind of power source you have, contact a qualified electrician.
- This machine is approved for use in the country of purchase only.

4 Never operate this machine if it has a damaged cord or plug, if it is not working properly, if it has been dropped or damaged, or water is spilled on the unit. Return the machine to the nearest authorized Brother dealer or service center for examination, repair, electrical or mechanical adjustment.

- To avoid electric shock or fire; do not use a damaged power supply plug or loose electrical outlet, and ensure that the power supply plug is fully inserted and secure.
- While the machine is stored or in use if you notice anything unusual, such as an odor, heat, discoloration or deformation, stop using the machine immediately and unplug the power cord.
- When transporting the machine, be sure to lift it from the bottom positions. Lifting the machine by any other part may damage the machine or result in the machine falling, which could cause injuries.
- When lifting the machine, be careful not to make any sudden or careless movements, otherwise you may injure your back or knees.
- While the machine is being transported, be careful not to touch the operation panel, thread guides or any other part, otherwise injuries may result.

5 Always keep your work area clear:

- Never operate the machine with any air openings blocked. Keep ventilation openings of the machine free from the build up of lint, dust, and loose cloth.
- Do not use extension cords. Plug the machine directly into the electrical outlet.
- Never drop or insert any object into any opening.
- Keep fingers out of all machine openings, such as near the carriage, otherwise injuries may result.
- Do not operate where aerosol (spray) products are being used or where oxygen is being administered.
- Do not use the machine near a heat source, such as a stove or iron; otherwise, the machine, power cord or garment being embroidered may ignite, resulting in fire or an electric shock.
- Do not use this machine near an open flame; the movement of the embroidery frame could cause the garment being embroidered to catch fire.

- Do not place this machine on an unstable surface, such as an unsteady or slanted table, otherwise the machine may fall, resulting in injuries.
- While attaching or detaching an embroidery frame or other included accessory or while maintaining the machine, be careful not to hit the machine with your body or any other part of it.

6 Special care is required when embroidering:

- Always pay close attention to the needle. Do not use bent or damaged needles.
- Keep fingers away from all moving parts. Special care is required around the machine needle.
- While the machine is in operation, keep your hands away from the needle bar case and all moving parts near the needle bar case, otherwise injuries may result.
- Switch the machine to the symbol "O" position to turn it off when making any adjustments in the needle area, such as changing the needle.
- Do not use a damaged or incorrect needle plate, as it could cause the needle to break.

7 This machine is not a toy:

- Your close attention is necessary when the machine is used by or near children.
- This machine is not intended for use by young children or infirm persons without supervision.
- Young children should be supervised to ensure that they do not play with this machine.
- This product contains small parts. Keep the product out of the reach of children to prevent accidental ingestion of small parts.
- Do not use the included scissors or seam ripper in any other way than how they are intended. In addition, when opening a hole with the seam ripper, do not place your hands or fingers in the cutting path, otherwise injuries may result if the seam ripper slips.
- The plastic bag that this machine was supplied in should be kept out of the reach of children or disposed of. Never allow children to play with the bag due to the danger of suffocation.
- Do not use outdoors.

8 For a longer service life:

- When using and storing this machine, avoid direct sunlight and high humidity locations. Do not use or store the machine near a space heater, iron, halogen lamp, or other hot objects.
- Do not use cleansers or organic solvents, such as thinner, petroleum ether or alcohol, to clean the

machine. Otherwise, the finish may peel off or become scratched.

- Always consult the Operation Manual when replacing or installing any assemblies, the presser feet, needle, or other parts to assure correct installation.

9 For repair or adjustment:

- Do not try to disassemble, repair or alter this machine in any way, otherwise a fire, electric shock or injuries may result.
- If the light unit is damaged, it must be replaced by an authorized Brother dealer.
- In the event a malfunction occurs or adjustment is required, first follow the troubleshooting table in the back of the Operation Manual to inspect and adjust the machine yourself. If the problem persists, please consult your local authorized Brother dealer.

Use this machine only for its intended use as described in the manual.

Use accessories recommended by the manufacturer as contained in this manual.

Use the interface cable (USB cable) included with this machine.

Values and measurements provides in inches are approximate. Actual values are provided in the metric unit of measurement.

The contents of this manual and specifications of this product are subject to change without notice.

For additional product information and updates, visit our website at www.brother.com

**SAVE THESE
INSTRUCTIONS**
**This machine is intended
for household use.**

**FOR USERS IN COUNTRIES EXCEPT
EUROPEAN COUNTRIES**

This appliance is not intended for use by persons (including children) with reduced physical, sensory or mental capabilities, or lack of experience and knowledge, unless they have been given supervision or instruction concerning use of the appliance by a person responsible for their safety. Children should be supervised to ensure that they do not play with the appliance.

**FOR USERS IN EUROPEAN
COUNTRIES**

This appliance can be used by children aged from 8 years and above and persons with reduced physical, sensory or mental capabilities or lack of experience and knowledge if they have been given supervision or instruction concerning use of the appliance in a safe way and understand the hazards involved. Children shall not play with the appliance. Cleaning and user maintenance shall not be made by children without supervision.

**FOR USERS IN THE UK,
EIRE, MALTA AND
CYPRUS ONLY**

IMPORTANT

- In the event of replacing the plug fuse, use a fuse approved by ASTA to BS 1362, i.e. carrying the  mark, rating as marked on plug.
- Always replace the fuse cover. Never use plugs with the fuse cover omitted.
- If the available electrical outlet is not suitable for the plug supplied with this equipment, you should contact your authorized Brother dealer to obtain the correct lead.

Federal Communications Commission (FCC) Supplier's Declaration of Conformity (For U.S.A. Only)

Responsible Party: Brother International Corporation
200 Crossing Boulevard
P.O. Box 6911
Bridgewater, NJ 08807-0911
USA
TEL : (908) 704-1700

declares that the product

Product Name: Brother Embroidery Machine
Model Number: PR1X

This device complies with Part 15 of the FCC Rules. Operation is subject to the following two conditions: (1) this device may not cause harmful interference, and (2) this device must accept any interference received, including interference that may cause undesired operation.

This equipment has been tested and found to comply with the limits for a Class B digital device, pursuant to Part 15 of the FCC Rules. These limits are designed to provide reasonable protection against harmful interference in a residential installation. This equipment generates, uses, and can radiate radio frequency energy and, if not installed and used in accordance with the instructions, may cause harmful interference to radio communications. However, there is no guarantee that interference will not occur in a particular installation. If this equipment does cause harmful interference to radio or television reception, which can be determined by turning the equipment off and on, the user is encouraged to try to correct the interference by one or more of the following measures:

- Reorient or relocate the receiving antenna.
- Increase the separation between the equipment and receiver.
- Connect the equipment into an outlet on a circuit different from that to which the receiver is connected.
- Consult the authorized Brother dealer or an experienced radio/TV technician for help.
- This transmitter must not be co-located or operated in conjunction with any other antenna or transmitter.

Important

Changes or modifications not expressly approved by Brother Industries, Ltd. could void the user's authority to operate the equipment.

This equipment complies with FCC/IC radiation exposure limits set forth for an uncontrolled environment and meets the FCC radio frequency (RF) Exposure Guidelines and RSS-102 of the IC radio frequency (RF) Exposure rules. This equipment should be installed and operated keeping the radiator at least 20cm or more away from person's body.

For Users in Canada

This device complies with Industry Canada's licence-exempt RSSs. Operation is subject to the following two conditions:

- (1) This device may not cause interference; and
- (2) This device must accept any interference, including interference that may cause undesired operation of the device.

This equipment complies with FCC/IC radiation exposure limits set forth for an uncontrolled environment and meets the FCC radio frequency (RF) Exposure Guidelines and RSS-102 of the IC radio frequency (RF) Exposure rules. This equipment should be installed and operated keeping the radiator at least 20cm or more away from person's body.

For Users in Mexico

The operation of this equipment is subject to the following two conditions:

- (1) it is possible that this equipment or device may not cause harmful interference, and
- (2) this equipment or device must accept any interference, including interference that may cause undesired operation.

La operación de este equipo está sujeta a las siguientes dos condiciones:

- (1) es posible que este equipo o dispositivo no cause interferencias perjudiciales y
- (2) este equipo o dispositivo debe aceptar cualquier interferencia, incluyendo la que pueda causar su operación no deseada.

Terms of Use

IMPORTANT-PLEASE READ CAREFULLY:

This Terms of Use ("Agreement") is a legal agreement between Brother Industries, Ltd. ("Company") and you that governs your use of any Software, installed on or made available by Company for use with the machine (including sewing, embroidery or craft products, collectively "Company Product"). The term of "Software" means any and all contents data (including without limitation design and embroidery data, collectively "Content"), data format, firmware of Company Product, and PC application or mobile device application.

By using the Software and Company Product, you shall be deemed to have agreed to be bound by the terms of this Agreement. If you do not agree to the terms of this Agreement, Company is unwilling to license the Software and you are not allowed to use the Software. Amendments and supplements to this Agreement may be attached to the Software.

An individual who accepts this Agreement on behalf of an entity represents to Company that he or she has the legal right to enter into a binding legal agreement for that entity.

Terms and Conditions

1 Grant of License.

- 1.1 Subject to this Agreement, Company hereby grants you a personal, non-exclusive, non-transferable and revocable license to use the Software only within the Company Product.
- 1.2 Your right to use of the Software is licensed and not sold, and solely for your use subject to this Agreement. Company or its suppliers retains all right, title, and interest relating to Software, including without limitation all intellectual property rights relating thereto.

2 Restrictions

- 2.1 Except as expressly set out in this Agreement or as required by any local law, you shall undertake:
 - 2.1.1 not to disassemble, de-compile, reverse engineer, translate or otherwise attempt to learn the source code of the Software (including Content created by using Company Product or contents editing application software; hereinafter the same shall apply in this Clause 2.);
 - 2.1.2 not to create derivative works based on the whole or any part of the Software, but excluding, Your Content set forth in Clause 7.2;
 - 2.1.3 not to distribute, provide or make available the Software in any form, in whole or in part to any person without prior written consent from Company;
 - 2.1.4 not to copy the Software, except where such copying is incidental to normal use of the Software with Company Product or where it is necessary for the purpose of back-up or operational security;

- 2.1.5 not to transfer, rent, lease, sub-license, loan, translate, merge, adapt, vary, alter or modify, the whole or any part of the Software nor permit the Software or any part of it to be combined with, or become incorporated in, any other programs;
- 2.1.6 to include Company's or its licensor's copyright notice and this Agreement on all entire and partial copies of the Software; and
- 2.1.7 not to use the Software for any purpose (including, but not limited to, use with unauthorized sewing/embroidery/craft products or software) other than as provided under Clause 1 of this Agreement.

3 No warranty

TO THE EXTENT PERMISSIBLE BY APPLICABLE LAW, THIS SOFTWARE IS PROVIDED TO YOU "AS IS" WITHOUT WARRANTIES OR CONDITIONS OF ANY KIND, WHETHER ORAL OR WRITTEN, EXPRESS OR IMPLIED. COMPANY SPECIFICALLY DISCLAIMS ANY IMPLIED WARRANTIES OR CONDITIONS OF MERCHANTABILITY, SATISFACTORY QUALITY, NON-INFRINGEMENT AND/OR FITNESS FOR A PARTICULAR PURPOSE.

4 Limitation of liability

- 4.1 COMPANY SHALL NOT BE LIABLE TO YOU, ITS END-USERS OR ANY OTHER ENTITY FOR ANY LOSS OF PROFITS OR INCOME OR SAVINGS, LOSS OF DATA, INTERRUPTION OF USE, OR CONSEQUENTIAL, INCIDENTAL, SPECIAL, PUNITIVE OR INDIRECT DAMAGES INCURRED BY SUCH PARTY (WHETHER IN AN ACTION IN CONTRACT OR TORT), EVEN IF COMPANY HAS BEEN ADVISED OF THE POSSIBILITY OF SUCH DAMAGES, ARISING OUT OF OR RELATING TO THE SOFTWARE, SUPPORT SERVICE OR THIS AGREEMENT. THESE LIMITATIONS SHALL APPLY TO THE MAXIMUM EXTENT ALLOWED BY APPLICABLE LAW NOTWITHSTANDING ANY FAILURE OF ESSENTIAL PURPOSE OF ANY LIMITED REMEDY.
- 4.2 NOTWITHSTANDING THE CLAUSE 3 OR 4.1 HEREOF, THIS AGREEMENT DOES NOT PURPORT TO EXCLUDE OR RESTRICT COMPANY'S LIABILITY FOR DEATH OR PERSONAL INJURY RESULTING FROM NEGLIGENCE OR LIMIT THE STATUTORY RIGHTS OF A CONSUMER.

- 5 Cost, charge incurred for your use of the Software.**
- 5.1 You agree and understand that service(s) available by the Software may be provided through any network communication and therefore, during the course of your using this Software, any communication charge due to utilization of such networks will occur, and you shall bear such charge.
- 5.2 In addition to the above charge, you are solely responsible for any costs or expenses incurred by you in connection with your use of the Software.
- 5.3 In no event shall Company reimburse you for any above charge, costs or expenses.
- 6 Support and Updates.**
- Company reserves the right, at its sole discretion, and with or without notice to you, to add or remove features or functions to or from the Software, or to provide programming fixes, enhancements, updates and upgrades, to the Software (collectively "Updates"). You agree that Company has no obligation to provide you with Updates, or make available to you any subsequent versions of the Software. You also agree that you may, in Company's sole discretion, be required to enter into a modified version of this Agreement if you want to use an Updates.
- 7 Use of Content**
- 7.1 You may use any Content uploaded or recorded or otherwise made available using, through or in connection with the Software by Company and its licensor (collectively "Company Content"). You may at least create hand-made craftwork items and use such hand-made craftwork items for private use by using Company Content. Any requirements in such private use (e.g. editing restrictions) and other conditions for use (e.g. prohibited commercial use of hand-made craftwork items) may depend on Company Content, respectively. Please see TERMS OF USE (FOR PATTERNS) accompanied by this Software or Company Products.
- 7.2 You may produce new Content using this Software or other devices connected to this Software by creating or editing. If you produce new content ("Your Content"), you shall use such Your Content at your own risk.
- 8 Your Obligations in respect of the Software**
- You warrant that you will:
- A) comply with all applicable laws, regulations and codes of practice with respect to your use of the Software;
 - B) not use the Software in a way which is unlawful, defamatory, obscene, indecent, offensive or threatening or which infringes the Intellectual Property Rights of any third party; and
 - C) not distribute or transmit any viruses, worms, Trojan horses or any other technologically harmful data, programs or software through, via or using the Software.

- 9 Termination**
- 9.1 Company shall have the right to terminate this Agreement at any time by providing a written notice to you if you commit a material breach of any terms of this Agreement and fail to immediately rectify such breach upon Company's request.
- 9.2 Upon termination for any reason all rights granted to you under this Agreement, you shall cease all activities authorized by this Agreement and you shall immediately delete or remove the Software from all computer equipment in your possession and delete or destroy all copies of the Software or its derivative works in your possession. In addition to the above, you shall delete Content created by you from the Company Product in your possession.
- 10 Miscellaneous terms**
- 10.1 You shall not export or re-export the Software or any copy or adaptation thereof in violation of any applicable laws or regulations.
- 10.2 Except for cases where transferring Company Products together with ownership, you shall not assign all or any part of this Agreement to any third party or any interest therein, without prior written consent of Company. A change of control or reorganization of you pursuant to a merger, sale of assets or stock shall be deemed to be an assignment under this Agreement.
- 10.3 You agree that a breach of this Agreement will cause irreparable injury to Company for which monetary damages would not be an adequate remedy and Company shall be entitled to seek equitable relief in addition to any remedies it may have hereunder or at law without a bond, other security, or proof of damages.
- 10.4 If any provisions of this Agreement shall be declared or determined as void or unenforceable by a court of competent jurisdiction, such provisions shall be severable and independent from the other provisions of this Agreement and the validity of the other provisions and of the entire Agreement shall not be affected thereby.
- 10.5 This Agreement, together with all exhibits or other attachments referenced herein, constitutes the entire agreement between the parties on the subject matter hereof, and supersedes all proposals, oral and written, between the parties on this subject.
- 10.6 If Company fails to insist that you perform any of your obligations under this Agreement, or if Company does not enforce any rights against you, or if Company delay in doing so, that will not mean that Company have waived any rights against you and will not mean that you do not have to comply with those obligations. If Company does waive a default by you, Company will only do so in writing, and that will not mean that Company will automatically waive any later default by you.

10.7 This Agreement is governed by the laws of Japan and Japanese Courts shall have exclusive jurisdiction with respect to this Agreement except with regard to enforcement in which case the jurisdiction of the Japanese Courts shall be non-exclusive.

10.8 The Company may update this Agreement in the following cases: A) When the changes are made for the users' benefit, or B) When the updates to the Agreement are adequate, reasonable, and not contrary to the purposes of the Agreement. Notwithstanding the foregoing, in principle, the contents of the amendments or modifications shall be published on the Company's website or by any other appropriate methods before the effective date of the amendments or modifications and enter into effect from the date that is separately specified in the notification.

11 Third-Party Software

The Software may contain third-party software and/or open source software programs (collectively, "Third-Party Software"). As for details of the Third-Party Software, please refer to the terms and condition separately defined.

TERMS OF USE (FOR PATTERNS)

All embroidery patterns, including but not limited to design and embroidery pattern and Content, in the machine ("Embroidery Patterns") is protected by copyright and other intellectual property rights (collectively "Intellectual Property Rights") owned by Company and/or its licensors.

You may use Embroidery Patterns and create hand-made craftwork items by using Embroidery Patterns for the sole purpose of using Company Product, subject to the following conditions:

If you do not agree to the terms of this conditions, Company is unwilling to license Embroidery Patterns and you are not allowed to use Embroidery Patterns.

YOU MAY NOT:

- use Embroidery Patterns in a way which is or in manner that could be considered unlawful, defamatory, obscene, indecent, offensive or threatening or which infringes the Intellectual Property Rights (including trademarks) of any third party;
- use Embroidery Patterns with deceptive advertising, with display for third party's merchandise or sales to cause confusion or for imitation merchandise of third party;

The following conditions apply to each Embroidery Patterns.

You may

- use and edit Embroidery Patterns for the sole purpose of using Company Product;
- create hand-made craftwork items by using Embroidery Patterns, and assign, sell, rent, distribute or otherwise transfer such hand-made craftwork items for a profit.

YOU MAY NOT:

- remove copyright notice in Embroidery Patterns;
- use Embroidery Patterns with falsely represent, expressly or by way of reasonable implication, that any Embroidery Patterns were created by you or a person other than the copyright holder(s) of that Embroidery Patterns;
- assign, distribute or otherwise transfer Embroidery Patterns to third party;
- use Embroidery Patterns as or in connection with trademarks, servicemark, logo or otherwise merchantability shape of you or third party;
- use Embroidery Patterns to cause confusion in connection with copyright notice of you or identical or similar to third party.

Laser Notices (For U.S.A. only)

Laser Safety

This machine is certified as a Class 1 laser product under the U.S. Department of Health and Human Services (DHHS) Radiation Performance Standard according to the Radiation Control for Health and Safety Act of 1968. This means that the sewing machine does not produce hazardous laser radiation.

IEC 60825-1 Specification

This machine is a Class 1 laser product as defined in IEC 60825-1:2007 and IEC 60825-1:2014 specifications.

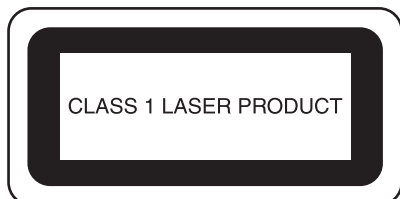

The laser beam emitted by the laser unit installed in this machine is restricted to an output at a safe level. However, the machine contains 6-milliwatt, 630-640 nanometer wavelength, 6-12 degree at parallel divergence angle, 28-40 degree at perpendicular divergence angle, InGaAlP laser diodes. Therefore, eye damage may result from disassembling or altering this machine.

Safety precautions have been designed to prevent any possible laser beam exposure to the operator.

FDA Regulations

U.S. Food and Drug Administration (FDA) has implemented regulations for laser products manufactured on and after August 2, 1976. Compliance is mandatory for products marketed in the United States. The label shown on the back of the sewing machine indicates compliance with the FDA regulations and must be attached to laser products marketed in the United States.

Brother Industries, Ltd.
15-1, Naeshiro-cho, Mizuho-ku, Nagoya 467-8561, JAPAN

This product complies with FDA performance standards for laser products except for conformance with IEC 60825-1 Ed. 3., as described in Laser Notice No. 56, dated May 8, 2019.

⚠ CAUTION

- Use of controls, adjustments or the performance of procedures other than those specified in this manual may result in hazardous radiation exposure.

Laser Notices (For European countries)

EN 60825-1:2014+A11:2021 and EN 50689:2021 Specification

This machine is Class 1 consumer laser product in EN60825-1:2014+A11:2021 and EN50689:2021 specifications. This laser indicates the needle drop point.



Laser Notices (For countries except U.S.A. and European countries)

IEC 60825-1 Specification

This machine is a Class 1 laser product as defined in IEC 60825-1:2007 and IEC 60825-1:2014 specifications.

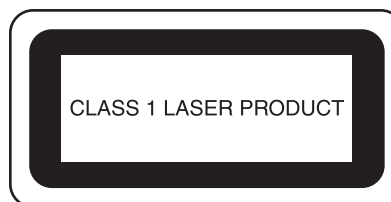

For countries except U.S.A.

The laser beam emitted by the laser unit installed in this machine is restricted to an output at a safe level. However, the machine contains 6-milliwatt, 630-640 nanometer wavelength, 6-12 degree at parallel divergence angle, 28-40 degree at perpendicular divergence angle, InGaAlP laser diodes. Therefore, eye damage may result from disassembling or altering this machine.

Safety precautions have been designed to prevent any possible laser beam exposure to the operator.

⚠ CAUTION

- This machine has a Class 3B Laser Diode in the Laser Unit. The Laser Unit should not be opened under any circumstances.
- Use of controls, adjustments or the performance of procedures other than those specified in this manual may result in hazardous radiation exposure.

LICENSE AGREEMENT

The enclosed machine includes data, software and/or documentation (collectively "CONTENT") that are proprietary products of Brother Industries, Ltd. ("BROTHER"). BY USING THE CONTENT, THE CUSTOMER ACCEPTS THE TERMS AND CONDITIONS OF THIS AGREEMENT. BROTHER retains ownership of all rights to CONTENT and to the copies of the CONTENT included in this package. The CONTENT are licensed (not sold) to you ("CUSTOMER") under the terms and conditions of this Agreement.

CUSTOMER is licensed to:

- Use the CONTENT in combination with an embroidery machine to create embroidery.
- Use the CONTENT in combination with an embroidery machine that CUSTOMER owns or uses, provided that the CONTENT is not used on more than one embroidery machine at a time.

Except as otherwise provided herein, CUSTOMER may not:

- Allow more than one copy of the CONTENT to be available for use at any one time.
- Reproduce, modify, publish, distribute, sell, rent, sublicense or otherwise make available to others CONTENT.
- Distribute, rent, sublicense, lease, sell, transfer or assign the media card or CONTENT.
- Decompile, disassemble or otherwise reverse engineer the CONTENT or assist others to do the same.
- Alter, translate, modify or adapt the CONTENT or any part thereof for business, commercial or industrial purposes.
- Sell or otherwise distribute the EMBROIDERY created by use of the CONTENT, WHICH ORIGINALLY BEARS CERTAIN COPYRIGHT NOTICE UNDER THE NAME OF ANY THIRD PARTIES OTHER THAN BROTHER (e.g. "©DISNEY").

BROTHER retains all rights not expressly granted to CUSTOMER herein.

Nothing in this agreement constitutes a waiver of the rights of BROTHER under any law. This agreement shall be governed by the laws of Japan.

Please direct all inquiries concerning this Agreement in writing by regular mail, to Brother Industries, Ltd., 1-1-1 Kawagishi, Mizuho-ku, Nagoya 467-8562, Japan, Attention: P&H business division Sales and Marketing Dept.

WARNING SIGN

The following warning signs are on the machine. Be sure to observe the precautions described in the signs.

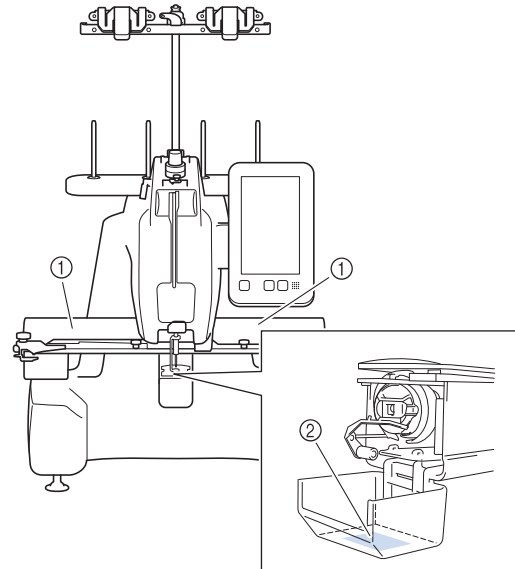

①	▲CAUTION	▲VORSICHT	▲ATTENTION	▲PRECAUCIÓN	▲CUIDADO
	Carriage may cause injury. Do not put hands in carriage traveling path.	Um Verletzungen mit dem Stickarm zu vermeiden, nicht die Hände in die Nähe des Stickarms halten.	Le chariot peut provoquer des blessures. Ne pas mettre les mains dans le chemin du chariot.	El carro puede provocar lesiones. No poner las manos por donde pasa el carro.	O carro de transporte pode causar ferimentos. Não coloque as mãos sobre o trilho do carro de transporte.

	▲VOORZICHTIG	▲ATTENZIONE	▲ОСТОРОЖНО!	▲注意	▲注意
	De borduurarm kan verwondingen veroorzaken. Houdt uw handen buiten bereik van de borduurarm.	Il carrello potrebbe ferirvi. Non appoggiate la mano nel percorso del carrello.	Движущаяся каретка может быть причиной травмы. Не кладите руки на пути движения каретки.	刺しゅう機のキャリッジや刺しゅう枠が動いているときに、手や腕を近づけないでください。	在绣花机的导轨或绣花框移动时，为避免造成伤害，请不要将手或物品靠近。

②

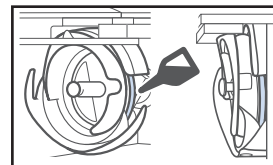

Please put a drop of oil onto the hook before use.

TRADEMARKS

Any trade names and product names of companies appearing on Brother products, related documents and any other materials are all trademarks or registered trademarks of those respective companies.

OPEN SOURCE LICENSING REMARKS

This product includes open-source software. To see the open source licensing remarks, please go to the manual download section on your model's home page of Brother support website at <https://s.brother/cpcab/> .

CONTENTS

Chapter 1 GETTING READY	13	PERFORMING THE EMBROIDERY	67
NAMES OF MACHINE PARTS	13	Starting embroidering	67
INCLUDED ACCESSORIES	15	Stopping embroidering	68
SETTING UP THE MACHINE	15	REMOVING THE EMBROIDERY FRAME	68
Setup and transporting precautions	15	ADJUSTING WHILE EMBROIDERING	69
Setup location	16	If the thread breaks or the bobbin thread runs out while	
Setting up the machine	16	embroidering	69
Preparing the thread guide assembly	16	Embroidering from the beginning or middle of the pattern	70
Attaching the Embroidery Frame Holder	17	Resume embroidering after turning off the machine	71
TURNING ON THE MACHINE	18	Chapter 3 ADVANCED EMBROIDERY	73
LCD SCREEN	20	VARIOUS EMBROIDERY FUNCTIONS	73
Using the settings key	20	Basting embroidery	73
Using the machine help	22	Embroidering appliqué patterns	74
		Using a frame pattern to create appliqués	75
		Making 3D font embroidery with urethane foam	76
Chapter 2 BASIC EMBROIDERY	23	USING THE EMBROIDERY CROSSHAIR	
BASIC PROCEDURES	23	POSITIONING LASER FUNCTION TO ALIGN THE	
INSTALLING THE BOBBIN	23	EMBROIDERING POSITION	77
Removing the bobbin case	23	MAKING EMBROIDERY ADJUSTMENTS	81
Winding the bobbin	24	Adjusting the tension of the bobbin thread	81
Installing the bobbin	27	Adjusting the tension of the upper thread	82
Installing the bobbin case	28	Uninterrupted embroidering (one color)	83
SELECTING AN EMBROIDERY PATTERN	28	Changing the display guides	84
General pattern selection	28	Changing the thread color information	85
Embroidery patterns	29	Starting position settings	85
Frame patterns	30	USING THE MEMORY FUNCTION	87
Monogram and frame designs	30	Saving embroidery patterns	87
Character patterns	32	Retrieving embroidery patterns	88
Decorative alphabet patterns	33	EMBROIDERY APPLICATIONS	88
Combining patterns	34	Embroidering split (large-size) patterns	88
EDITING THE EMBROIDERY PATTERN	35		
Understanding the pattern editing screen	35	Chapter 4 APPENDIX	91
Changing the thread density (only for some character and frame		MAINTENANCE	91
patterns)	38	Cleaning the LCD	91
Designing repeated patterns	38	Cleaning the machine surface	91
EDITING COLORS	42	Cleaning the hook	91
Specifying multi-color text	42	Cleaning around the needle plate	92
Changing the colors of the pattern	42	Cleaning the bobbin case	93
Creating a custom thread table	43	Cleaning the thread paths of the upper threads	93
Selecting a color from the custom thread table	45	Replacing the needle	94
Saving and retrieving the custom thread table	46	Oiling the machine	96
PREVIEWING THE IMAGE	47	About the maintenance message	97
Checking a preview image	47	Replacing the hook of the automatic needle-threading	97
PREPARING THE FABRIC	47	BEFORE LENDING OR DISPOSING OF THE	
Attaching stabilizer (backing) to fabric	47	PRODUCT	98
Fabric/stabilizer compatibility chart	48	TROUBLESHOOTING	98
Hooping the fabric in the embroidery frame	48	List of Symptoms	98
ATTACHING THE EMBROIDERY FRAME TO THE		Error messages	104
MACHINE	52	If the machine does not respond when a key is touched	106
Attaching the embroidery frame	52	SPECIFICATIONS	107
Correctly using the embroidery frames	53	Machine specifications	107
SPECIFYING EMBROIDERING SETTING	56	UPDATING YOUR MACHINE'S SOFTWARE	109
Understanding the embroidering screen	56	Using USB media to update	109
Using the automatic thread cutting function		Using computer to update	110
[End Color Trim]	58	INDEX	111
Using the thread trimming function [Jump Stitch Trim]	58		
Thread color sorting	59		
CHECKING THE POSITION OF THE PATTERN	60		
Checking the needle drop point with the Embroidery Crosshair			
Positioning Laser	60		
Checking the embroidery pattern	61		
UPPER THREADING	61		
Upper threading	62		
Threading the needle	65		
Easily changing the thread spools	66		

Chapter 1 GETTING READY

Note

- Be sure to install the latest software. Refer to "UPDATING YOUR MACHINE'S SOFTWARE" on page 109.

NAMES OF MACHINE PARTS

■ Front view

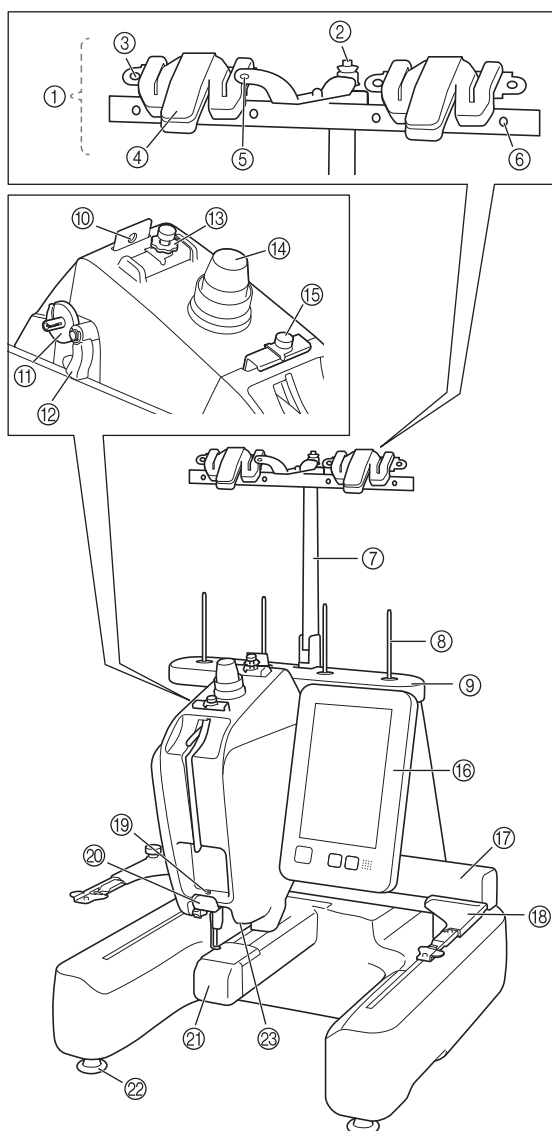

- ① Thread guide assembly (page 16)
- ② Bobbin pretension disc (page 25)
- ③ Thread guide hole (page 25)
- ④ Thread cutter/holder (page 64, page 66)
- ⑤ Front hole in the thread guide (page 25)
- ⑥ Thread guide hole (page 25, page 63)
- ⑦ Thread guide assembly support (page 16)
- ⑧ Spool pin
- ⑨ Spool stand
- ⑩ Thread guide (page 63)
- ⑪ Bobbin winder seat (page 24)
- ⑫ Bobbin winding switch (page 26)
- ⑬ Upper thread guide pretension knob (page 82)
- ⑭ Thread tension knob (page 82)
- ⑮ Middle thread guide (page 63)
- ⑯ Operation panel (page 14)
- ⑰ Carriage

Attach the Embroidery Frame Holder to the carriage. When the machine is turned on or when the machine is embroidering, the carriage moves forward, backward, left and right.
- ⑱ Embroidery Frame Holder (page 17)
- ⑲ Lower thread guide (page 64)
- ⑳ Thread cutter (page 65)
- ㉑ Hook cover/Hook (page 23)
- ㉒ Feet (page 16)
- ㉓ Embroidery light (page 21)

■ Right-side/rear view

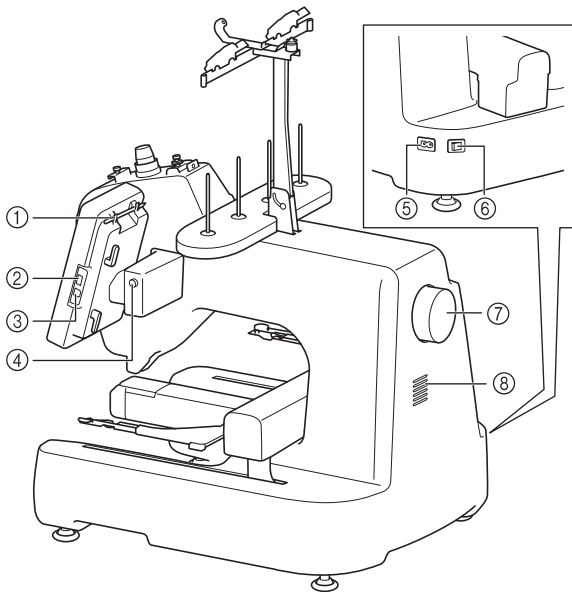

- ① **Touch pen holder**
Use the touch pen holder to hold the touch pen when not in use.
- ② **USB port (USB 2.0) (page 87, page 109)**
In order to send patterns from/to USB media, plug the USB media directly into the USB port.
- ③ **USB port for computer (page 87)**
In order to import/export patterns between a computer and the machine, plug the USB cable into the USB port.

IMPORTANT

- Do not insert anything other than a USB flash drive into the USB port. Anything else may damage the machine.

- ④ **LCD panel angle button**
Press to change the angle of the operation panel. Do not change the angle without pressing this button.
- ⑤ **Power cord receptacle (page 18)**
- ⑥ **Main power switch (page 18)**
Use the main power switch to turn the machine ON (I) and OFF (O). Do not turn the power on soon after turning the power off. It is recommended that you wait 5 seconds before turning the power back on.
- ⑦ **Handwheel**
Rotate the handwheel to move the needle up and down. Be sure to rotate the handwheel toward the operation panel.
- ⑧ **Ventilation slots**
The ventilation slots allow the air surrounding the motor to circulate. Do not cover the ventilation slots while the machine is being used.

■ Operation panel

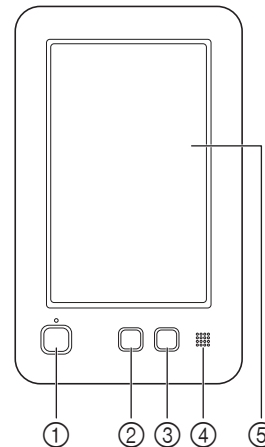

- ① **“Start/Stop” button**
Press the “Start/Stop” button to start or stop the machine. The lighting status and color of the button changes depending on the operation condition of the machine.

Lit in red	:	When the machine cannot start embroidering
Flashing in green	:	When the machine can start embroidering
Lit in green	:	While the machine is embroidering
Off	:	When the machine is turned off
- ② **Thread trimming button**
Press the thread trimming button to trim both the upper and the bobbin threads.
- ③ **Automatic needle-threading button**
Press the automatic needle-threading button to thread the needle.
- ④ **Speaker**
- ⑤ **LCD (touch panel)**
Touch the keys that appear on the touch panel to select and edit patterns and confirm various information.

INCLUDED ACCESSORIES

For included accessories of your machine, refer to the additional sheet "Included Accessories".

SETTING UP THE MACHINE

Setup and transporting precautions

⚠ CAUTION

- The transporting or setting up of the machine should be performed by two people. When transporting the machine, be sure to have two people lift the machine from the bottom at the indicated slots (①). Lifting the machine from any other area may damage the machine or result in the machine falling, which could cause injuries.

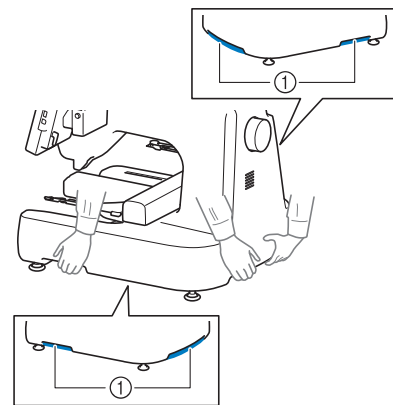

- Do not plug in the power supply cord until setup of the machine is completed, otherwise injuries may result if the "Start/Stop" button is accidentally pressed and the machine starts embroidering.
- When lubricating the machine, wear protective eyeglasses and gloves to prevent the oil or grease from getting into your eyes or on your skin. Do not put the oil or grease into your mouth. Keep the oil and grease out of the reach of children.
- In order to prevent malfunctions or damage, do not set up the machine in a location exposed to the following conditions.
 - Liquids, such as water
 - Extreme dust
 - Direct sunlight
 - Extremely high or extremely low temperatures. The operating environment should be between 5 °C (40 °F) and 40 °C (104 °F).
 - Insufficient space (page 16, page 107)
 - Objects within the moving range of the embroidery frame
 - Blocked ventilation slots at the back and on the rear underside of the machine
 - An unstable surface

Setup location

Set up the machine in a location that meets the following requirements. (For the weight and dimensions of the machine as well as the space required for installation, refer to "SPECIFICATIONS" on page 107.)

- Allow sufficient space around the machine.
- Place no objects within the moving range of the embroidery frame.
- Set-up machine near an electrical outlet.
- Use a level and stable surface, such as a desk or stand.
- Use a surface that can support the weight of the machine.
- Allow open space around the ventilation slots at the back and on the rear underside of the machine.

Setting up the machine

When setting up the machine, adjust the legs so that the machine is steady.

- 1** Make sure that all packing tape affixed to the machine is peeled off and that all packing material is removed.

- 2** Set up the machine while making sure that there is sufficient space around it.

For details on the setup location, refer to "Setup location" on page 16 and "SPECIFICATIONS" on page 107.

- 3** Adjust the legs so that the machine is steady.

Use the included wrench to loosen the lock nut on the leg that you wish to adjust.

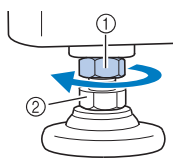

- ① Lock nut
- ② Adjustable foot nut

→ The foot can be turned.

- 4** Use the included wrench to turn the adjustable foot nut on the foot.

Turning the nut in direction ① lengthens the leg; turning the nut in direction ② shortens the leg.

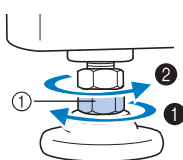

- ① Adjustable foot nut

- Adjust all four legs so that they securely contact the desk or table, and the machine is level.

- 5** After adjusting the legs to the desired length, use the included wrench to tighten the nuts.

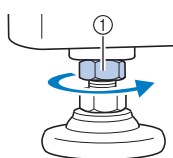

- ① Lock nut

- 6** Press down on each corner of the machine to check that it is stable.

If it is still unstable, perform steps ③ through ⑤ again to adjust the legs.

Preparing the thread guide assembly

Assemble the thread guide assembly. Locate the included Phillips screwdriver.

- 1** Remove the two screws from the thread guide assembly support.

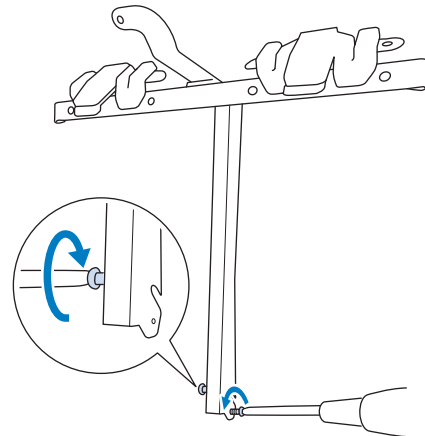

- 2** Slide the thread guide assembly support onto the machine, and then tighten the screw, until the thread guide assembly support is secure.

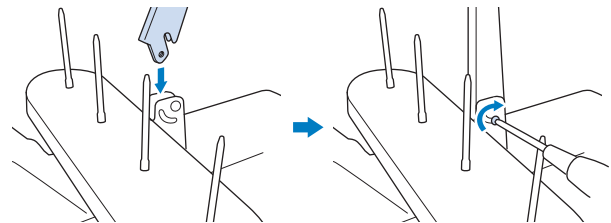

- 3** Tighten the screw on the opposite side of the thread guide assembly support in the same manner.

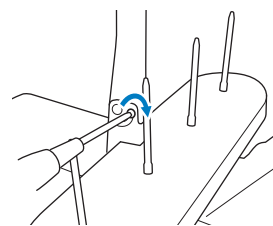

Note

- Do not apply extreme force when moving the thread guide assembly support and thread guide assembly.
- Be sure to tighten each screw well enough that the thread guide assembly is secured.

Attaching the Embroidery Frame Holder

- 1 Use the Embroidery Frame Holder appropriate for the embroidery frame that you are using. (page 53 to page 55)
- 2 Remove the two thumb screws of the Embroidery Frame Holder.

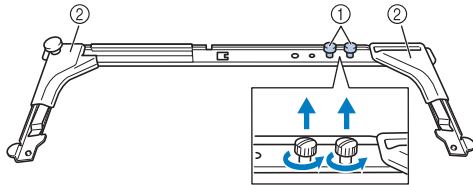

- ① Thumb screws
- ② Corner covers

Note

- Using the 3-way screwdriver included, loosen and firmly tighten the thumb screws.

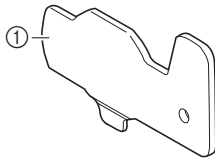

- ① Use this part to tighten the thumb screws of the Embroidery Frame Holder.

- 3 Align the holes in the Embroidery Frame Holder with the pins on the frame-mounting plate of the carriage.

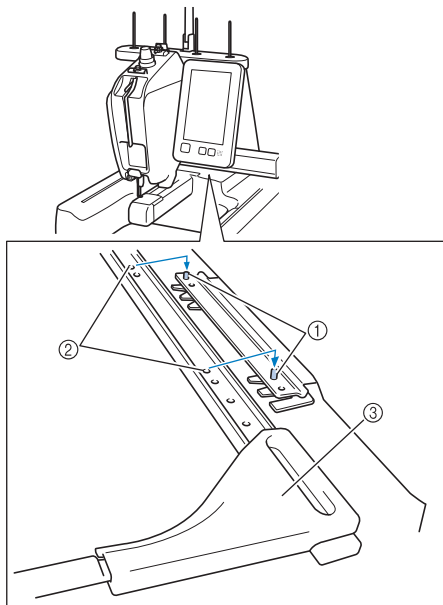

- ① Pins on the frame-mounting plate
- ② Holes in the Embroidery Frame Holder
- ③ Corner covers

- 4 Secure the Embroidery Frame Holder with the two thumb screws removed in step 2.

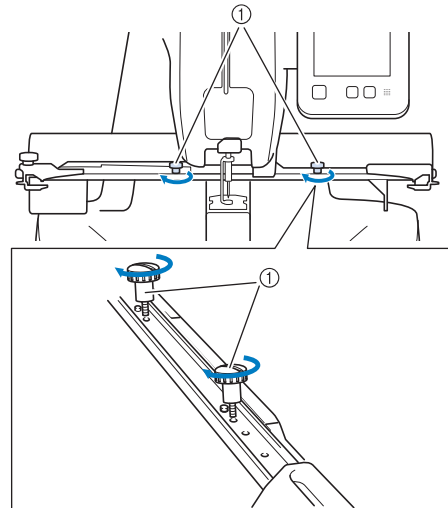

- ① Thumb screws

This completes the preparation of the machine.

TURNING ON THE MACHINE

⚠ WARNING

- Use only regular household electricity for the power source. Using other power sources may result in fire, electric shock, or damage to the machine.
- Do not plug in or unplug the power supply cord with wet hands, otherwise an electric shock may result.
- If any of the following occur, turn off the machine and unplug the power supply cord, otherwise a fire, an electric shock or damage to the machine may result.
 - When you are away from the machine.
 - After using the machine.
 - If a power outage occurs while the machine is being operated.
 - If the machine is not operating properly, for example, when there is a loose or cut connection.
 - During electrical storms.

⚠ CAUTION

- Do not plug this machine in with extension cords or multi-plug adapters with any other appliances plugged into them, otherwise a fire or an electric shock may result.
- When unplugging the power supply cord, be sure to first turn off the machine, and then grasp the plug when unplugging the cord. Pulling on the cord may damage it or result in a fire or an electric shock.
- Do not allow the power supply cord to be cut, damaged, modified, forcefully bent, pulled, twisted, or bundled. In addition, do not place heavy objects on the cord or expose it to heat, otherwise damage to the cord, fire or an electric shock may result. If the power supply cord or its plug is damaged, stop using the machine, and then take the machine to your authorized Brother dealer for repairs before continuing use.
- For U.S.A. only
This appliance has a polarized plug (one blade wider than the other). To reduce the risk of electrical shock, this plug is intended to fit in a polarized outlet only one way. If the plug does not fit fully in the electrical outlet, reverse the plug. If it still does not fit, contact a qualified electrician to install the proper electrical outlet. Do not modify the plug in any way.

- 1 Insert the power supply cord into the power cord receptacle, then insert the plug into a wall outlet.

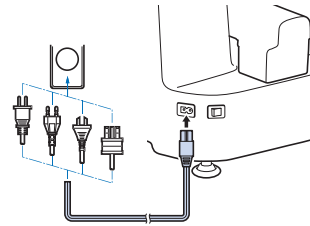

- 2 Switch on the main power switch on the back of the machine to "I".

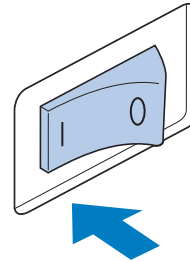

→ The LCD screen comes on, and then the opening movie starts. The "Start/Stop" button lights up.

- 3 Touch anywhere on the screen.

→ The message screen to move the carriage appears.

IMPORTANT

- In order to prevent malfunctions or damage, do not place any objects within the moving range of the carriage.

- 4 Keep your hands and other objects away from the carriage, and then touch .

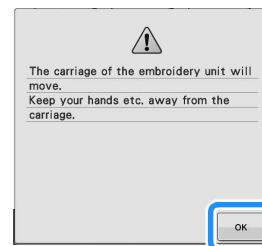



→ The carriage moves to its initial position, and the pattern type selection screen appears.

- 5 Set the main power switch to "O" to turn off the machine.

■ Setting your machine for the first time

When you first turn on the machine, set the language and time/date to your language and local time/date.

- 1 Touch  and  to set your local language and then touch .

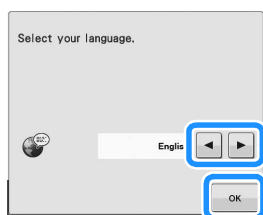

→ The message screen, confirming if you want to set time/date, appears.

- 2 In order to set time/date, touch .

- 3 Touch  or  to set time/date.

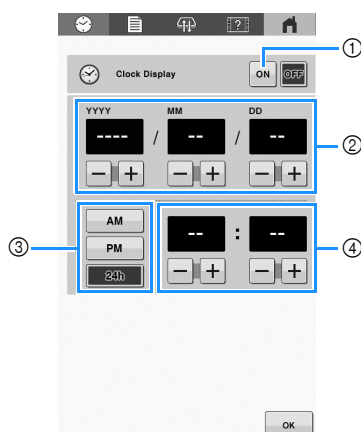

- ① Select [ON] to display time/date on the screen.
- ② Set the year [YYYY], month [MM] and date [DD].
- ③ Select whether 24h or 12h setting to display.
- ④ Set the current time.

- 4 Touch  to start using the machine.

→ The clock starts from 0 second of the time you set.

Memo

- The time/date you set may be cleared if you don't turn on the machine for an extended period of time.
- Time setting is also available by touching  on the LCD screen.

LCD SCREEN

IMPORTANT

- Only touch the screen with your finger or the touch pen included with the machine. Do not use a mechanical pencil, screwdriver or any other hard or sharp object. In addition, do not touch the screen with extreme pressure. Otherwise the screen may be damaged.

■ Pattern type selection screen

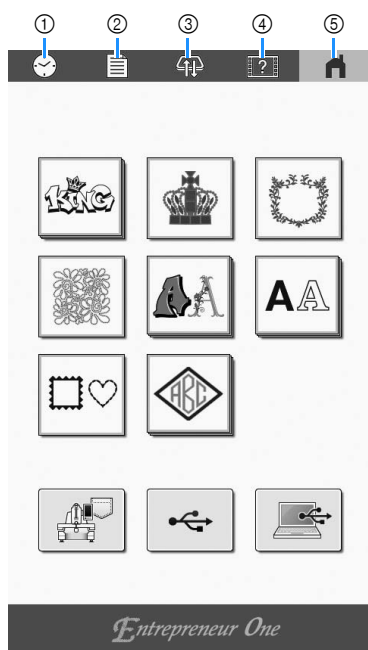

No.	Display	Function	Page
	Key Name		
①		Set the clock to your local time.	19
	Clock key		
②		Change the machine settings.	20
	Settings key		
③		Position the carriage so the embroidery frame can easily be removed or attached.	53
	Frame move key		
④		Check a machine operation.	22
	Machine operations guide key		
⑤		Cancel all operations previously performed and return to the initial pattern type selection screen.	-
	Home key		

Using the settings key

You can change the various machine settings. After changing the settings, touch .

Memo

- Touch or to display the previous or next page.

■ Page 1

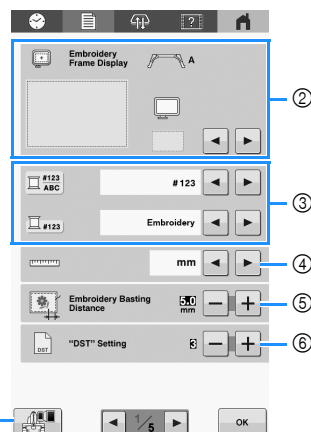

- ① An image of the current settings screen can be saved on USB media.
- ② The guides (center point marker and grid) for the pattern display area can be specified. (page 84)
- ③ The color information can be switched to the color name or the thread brand and color number. (page 85)
- ④ Select the display units for embroidering (mm/inch).
- ⑤ Specify the distance between the pattern and the basting stitching. (page 73)
- ⑥ When using Tajima embroidery data (.dst), you can specify whether or not the thread is cut according to the jump codes. (page 59)

■ Page 2

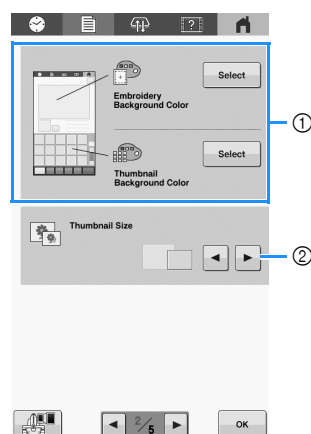

- ① Depending on the color of the embroidery, changing the background color of the pattern display area and thumbnails may make them more visible and easier to select.
- ② Specifies whether the size of image keys that appear when selecting a pattern from the pattern list screen are displayed "Small" or "Large".

Page 3

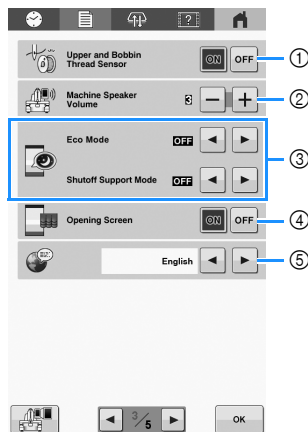

- ① Turn both the upper and bobbin thread sensors [ON] or [OFF]. If it is turned [OFF], the machine can be used without upper thread.
- ② The volume of operation sounds and alarm sounds can be adjusted.
- ③ Select to save the machine power by setting the [Eco Mode] or the [Shutoff Support Mode]. (page 22)
- ④ The machine can be set so that the opening screen is either displayed ([ON]) or not displayed ([OFF]) when the machine is turned on.
- ⑤ Select the display language. The keys and messages appear in the selected language.

Page 4

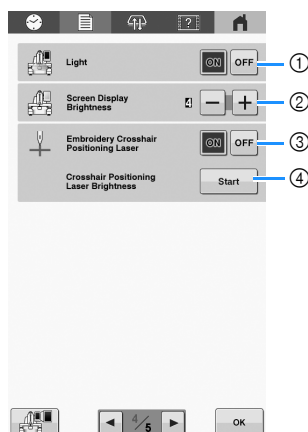

- ① The light can be set to be turned either [ON] or [OFF].
- ② Change the screen display brightness.
- ③ Set [Embroidery Crosshair Positioning Laser] to [ON] or [OFF].
- ④ Set the brightness of the Embroidery Crosshair Positioning Laser. (page 60)

Page 5

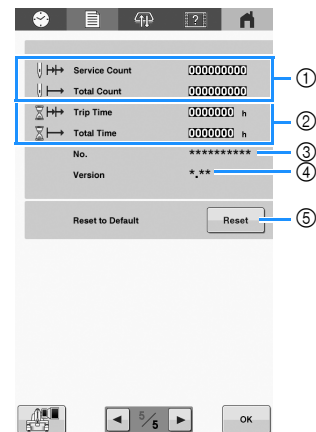

- ① [Total Count] shows the total number of stitches embroidered, and [Service Count] show the number of stitches that have been embroidered since the machine's last maintenance.
- ② [Total Time] shows the total amount of time that the machine has been used, and [Trip Time] shows the amount of time that the machine has been used since its last maintenance.
- * Use counters ① and ② as a standard for performing periodic maintenance and for scheduling professional maintenance for the machine.
- ③ Shows the internal machine number for this machine.
- ④ Shows the version of the software installed on this machine.
- ⑤ Return all data and settings saved in the machine to the factory defaults. (page 98)



■ Setting the [Eco Mode] and the [Shutoff Support Mode]

You can save the machine power by setting the [Eco Mode] and the [Shutoff Support Mode]. Touch  to display [Eco Mode] and [Shutoff Support Mode]. (page 21) If you leave the machine turned on without using it for a set period of time, the machine will enter one of the modes below.

[Eco Mode]:

Machine will enter a sleep mode after the set period of time. Touch the screen or press the “Start/Stop” button to continue operating.

[Shutoff Support Mode]:

Machine will turn off after set period of time. Turn the machine off and then back on to restart operating.

Note

- If you turn off the machine while the machine is in the [Eco Mode] or the [Shutoff Support Mode], wait for about 5 seconds before turning on the machine again.

Memo

- For details on setting the [Eco Mode] and the [Shutoff Support Mode], refer to “SPECIFICATIONS” on page 107.

Using the machine help

Touch  to display the machine help screen.

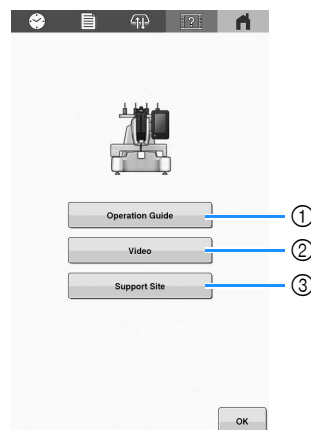

- ① Explanation for upper threading, installing the bobbin, preparing to embroider a pattern, and how to use the machine. For details, refer to “Using the operation guide function” below.
- ② Use the QR code that appears in the screen to access instruction videos for the machine.

Memo

- A video is available on the instruction video site for items marked with  in this manual.
- ③ Use the QR code that appears in the screen to access the Brother support website.

■ Using the operation guide function

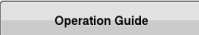
Touch  to display the screen shown below. Touch a key to see more information about the category.



- ① Information about the main parts of the machine and their functions
- ② Information about threading the machine, hooping the fabric in the embroidery frame, etc.
- ③ Information about troubleshooting
- ④ Information about cleaning the machine, etc.

Chapter 2 BASIC EMBROIDERY

2

BASIC PROCEDURES

Basic embroidering procedures are described below. Check the overall procedure below, before operating the machine.

Step	Operation	Reference Page
1	Turn on the machine.	18
2	Install the bobbin.	23
3	Select an embroidery pattern.	28
4	Edit the embroidery pattern.	35
5	Check the previewed image.	47
6	Hoop the fabric in the embroidery frame.	48
7	Attach the embroidery frame to the machine.	52
8	Specify the embroidering settings.	56
9	Checking the position of the pattern.	60
10	Thread the upper threads.	61
11	Touch the "Start/Stop" button to start embroidering.	67
12	Remove the embroidery frame.	68
13	Turn off the machine.	18

INSTALLING THE BOBBIN

When the machine is purchased, only the bobbin case is installed in the hook. Insert a bobbin wound with bobbin thread for embroidering.

IMPORTANT

- Be sure to use prewound bobbins (Fil-Tec/ TRU-SEW POLYESTER "Filaments"), the included metal bobbins or bobbins designed specifically for this machine.

Note

- Before starting to embroider make sure that there is enough bobbin thread for the pattern.
- Make sure to clean the bobbin case every time the bobbin is changed. (page 93)

Removing the bobbin case

- 1 Open the hook cover.
Pull the hook cover toward you.

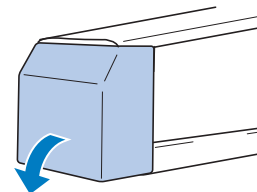

- 2 Pull the thread picker toward you if it was not pulled toward the front.

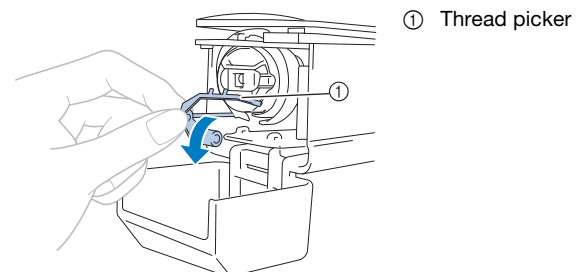

To gain access to the bobbin case easily, pull the thread picker toward front.

Memo

- Thread picker is a device that is used to hold the thread when beginning to embroider or when trimming the thread.

IMPORTANT

- The thread picker can only be moved within a certain range. Do not pull it with extreme force.

- 3 Grab the bobbin case latch, and remove the bobbin case.

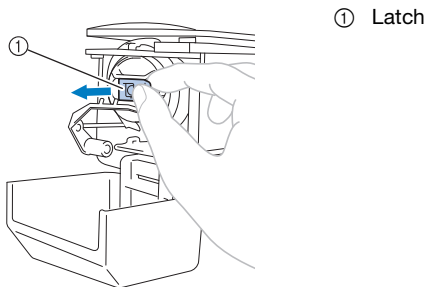

■ Oiling the machine

After removing the bobbin case, apply oil to the machine. (page 96)

💡 Note

- Put a drop of oil onto the hook once a day before use.

Winding the bobbin



(page 22):
An instruction video is available for this topic.

💡 Note

- Use cotton or spun polyester bobbin thread (from #90 to 120, or 74 dtex/2 to 100 dtex/2).
- Circled numbers on the thread guide assembly indicate the threading path for winding the bobbin. Also refer to these while threading the machine.

Prepare the included metal bobbin or bobbins designed specifically for this machine and the spool of bobbin thread.

- 1 Turn the main power to ON.

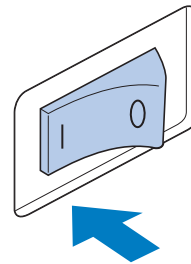

- 2 Align the groove in the bobbin with the spring on the bobbin winder seat, and set the bobbin on the bobbin winder seat.

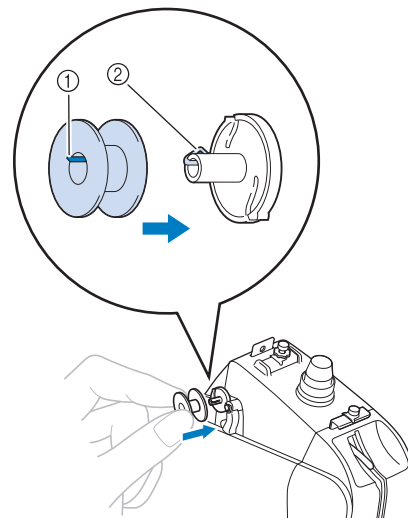

- ① Groove in the bobbin
- ② Spring on the bobbin winder seat

3 Place the thread spool on either the first or second spool pin on the left side. Push the spool cap onto the spool pin as far as possible to secure the thread spool.

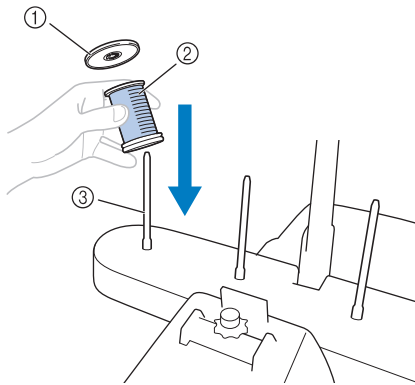

- ① Spool cap
- ② Thread spool
- ③ Spool pin

4 Pass the thread through the thread guide hole just above the spool from the back to the front.

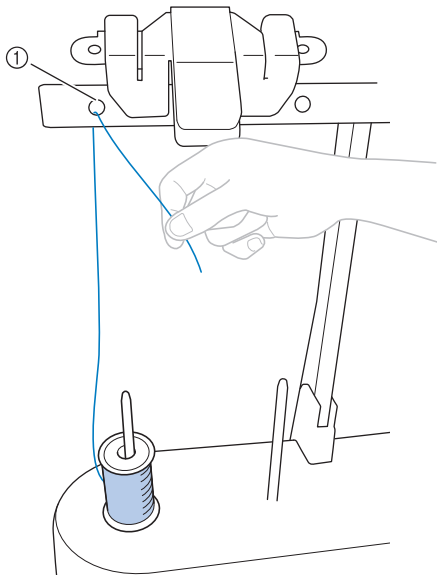

- ① Thread guide hole above the spool

5 Pass the thread through thread guide hole from front side to back.

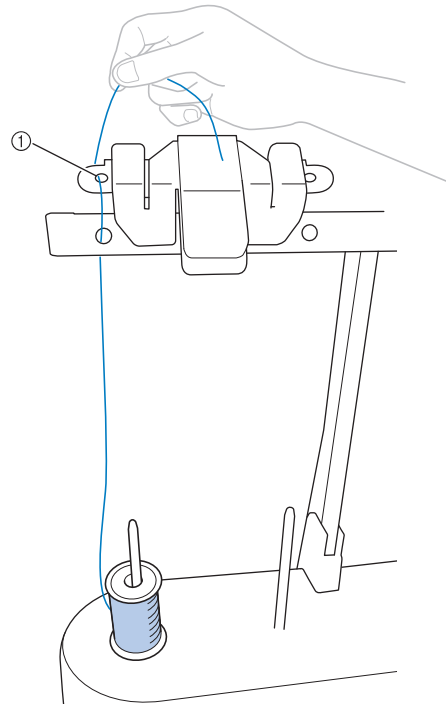

- ① Thread guide hole

6 Pass the thread around the bobbin pretension disc as shown in the illustration. Make sure that the thread is correctly fed into the bobbin pretension disc.

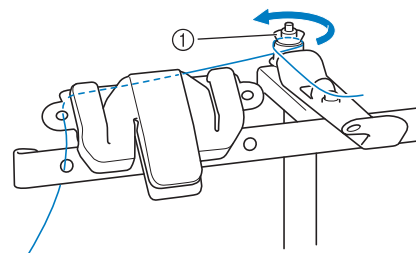

- ① Bobbin pretension disc

7 Pass the thread through the front hole in the thread guide towards you as shown in the illustration.

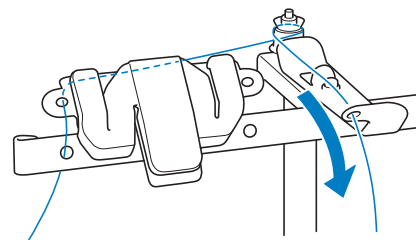

- 8 Wind the thread clockwise around the bobbin 4 or 5 times, as shown in the illustration.

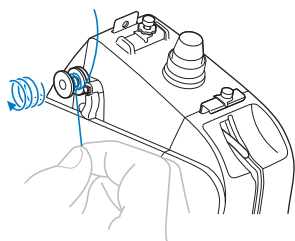

- 9 Pass the end of the thread through the guide slit on the bobbin winder seat, and pull the thread. The cutter will cut the thread.

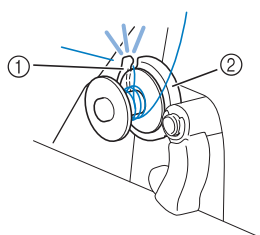

- ① Guide slit (with built-in cutter)
② Bobbin winder seat

⚠ CAUTION

- Be sure to follow the procedure described. If the bobbin is wound without the thread being cut with the cutter, when the bobbin thread runs low, the thread may become tangled around the bobbin and cause the needle to break, resulting in injury.

- 10 Push the bobbin winding switch to the left, until it clicks into place.

→ The bobbin winding window will be displayed on the LCD screen.

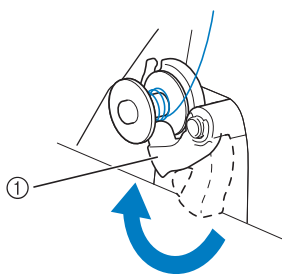

- ① Bobbin winding switch

- 11 Touch **Start**.

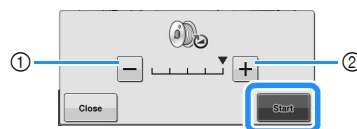

- ① Touch to decrease the bobbin winding speed.
② Touch to increase the bobbin winding speed.

→ The bobbin starts winding. The bobbin stops rotating when bobbin winding is completed. The bobbin winding switch will automatically return to its original position.

📌 Memo

- Start** changes to **Stop** while the bobbin is winding. Touch **Stop** if you want to stop before the bobbin is fully wound.
- Stay near the machine while winding the bobbin to make sure the bobbin thread is being wound correctly. If the bobbin thread is wound incorrectly, touch **Stop** immediately to stop the bobbin winding.
- Touch **Close** to minimize the bobbin winding window. Then, you can perform other operations, such as selecting a pattern or adjusting the thread tension, while the bobbin is being wound.
- Touch **0** (in top right of the LCD screen) to display the bobbin winding window again.



- 12 Cut the thread with the cutter and remove the bobbin.

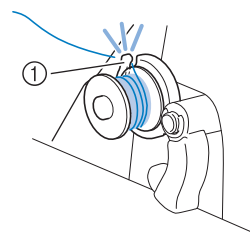

- ① Cutter

IMPORTANT

- When removing the bobbin, do not pull on the bobbin winder seat. Doing so could loosen or remove the bobbin winder seat, and could result in damage to the machine.

⚠ CAUTION

- Be sure to use a bobbin that has been correctly wound. Otherwise, the thread tension may be incorrect and the needle may break, causing injuries.

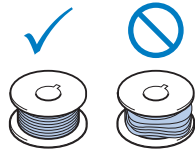

💡 Note

- Be sure to clean the bobbin case each time that the bobbin is changed. For details, refer to “Cleaning the bobbin case” on page 93.
- Be sure to check the tension of the bobbin thread each time that the bobbin is changed. For detailed instructions on how to adjust the bobbin tension, refer to page 81.

Installing the bobbin

1 Insert the bobbin into the bobbin case.

- Prewound bobbin

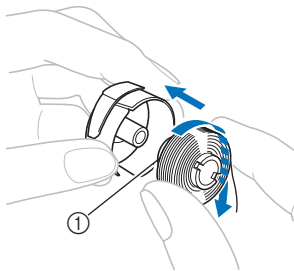

① Magnet Tip

- Metal bobbin (page 24)

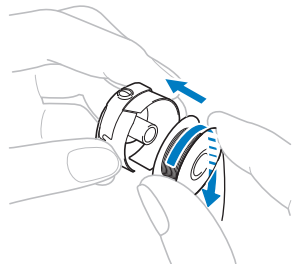

💡 Note

- Check that the thread winds off the bobbin clockwise as shown in the illustration. If the bobbin is installed with the thread winding off in the opposite direction, the embroidery will not be stitched correctly.

2 Pass the thread through the thread slit and under the tension-adjusting spring.

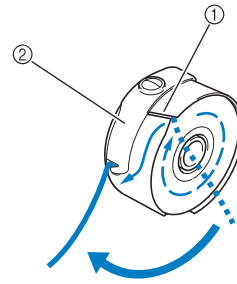

- ① Thread slit
- ② Tension-adjusting spring

3 Pull the thread through the opening in the tension-adjusting spring.

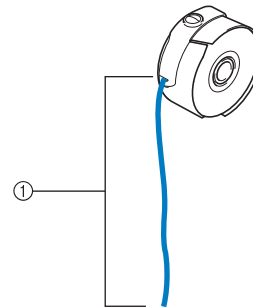

① About 5 cm (approx. 2 inches)

- For details, refer to “Adjusting the tension of the bobbin thread” on page 81.

Installing the bobbin case

1 Insert the bobbin case into the hook.

Insert the bobbin case while aligning the tab on the bobbin case with the notch in the hook, as shown in the illustration.

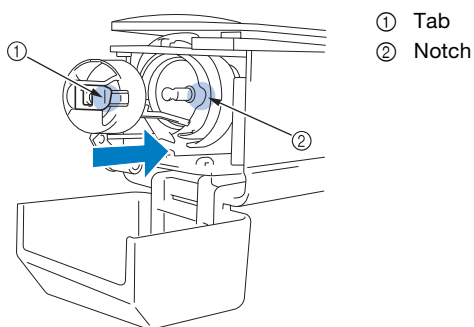

- Fully insert the bobbin case until it snaps into place.

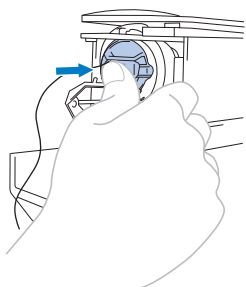

2 Close the hook cover.

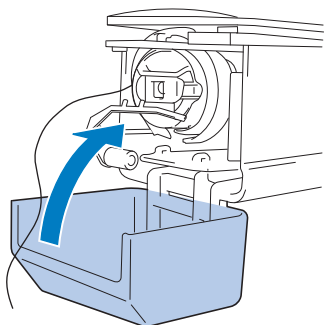

SELECTING AN EMBROIDERY PATTERN

General pattern selection



(page 22):

An instruction video is available for this topic.

The procedure for selecting a pattern differs depending on the type of pattern; however, the general procedure for selecting a pattern is described below.

1 In the pattern type selection screen, touch the key for the desired category.

■ Pattern type selection screen

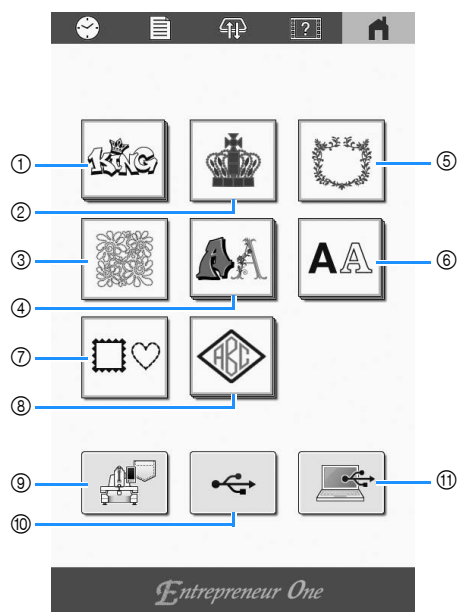

- ① "Featured" design patterns
- ② Embroidery patterns (page 29)
- ③ Quilt design patterns
- ④ Decorative alphabet patterns (page 33)
- ⑤ Decoration/Hallmark patterns
- ⑥ Character patterns (page 32)
- ⑦ Frame patterns (page 30)
- ⑧ Monogram and frame patterns (page 30)
- ⑨ Patterns stored in the machine's memory (page 87)
- ⑩ Patterns saved on USB media (page 87)
- ⑪ Patterns saved on a computer (page 87)

2 After you select the Pattern type, touch the desired pattern to select it as shown below.

■ Pattern list screen

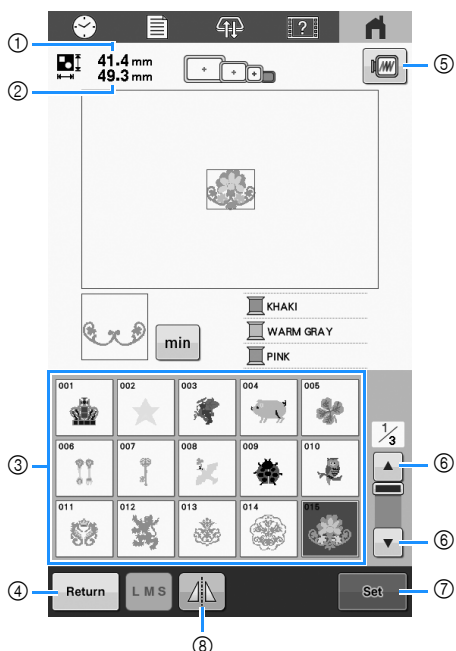

- ① Shows the height of the pattern.
- ② Shows the width of the pattern.
- ③ Touch a pattern to display the information of the pattern.
- ④ Return to pattern type selection screen.
- ⑤ Preview the embroidery image.
- ⑥ Touch until the desired page is displayed if there is more than one page.
- ⑦ Confirm the pattern, and move to the pattern editing screen.
- ⑧ Flip the pattern being edited horizontally.

Embroidery patterns

1 Touch .

2 Select an embroidery pattern.
→ The selected pattern appears in the pattern display area.

3 Touch .

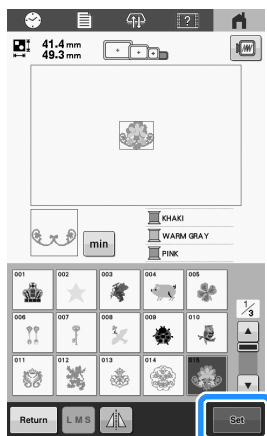

→ The pattern editing screen appears.

4 Edit the selected pattern. (page 35)

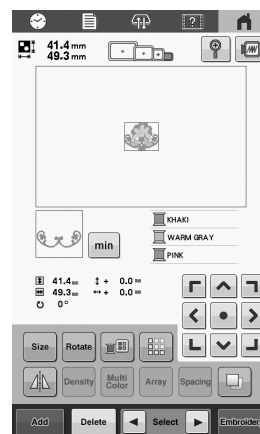

5 Hoop the stabilizer and fabric in the embroidery frame. (page 48)

6 Attach the embroidery frame to the machine. (page 52)

7 Touch .
→ The embroidering screen appears.

8 Review the Embroidery Settings for this pattern. (page 56)

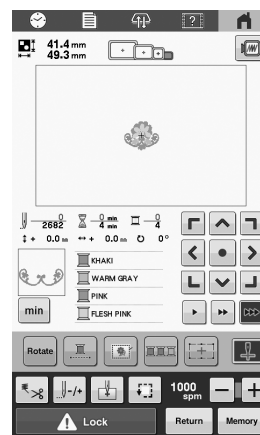

9 Check the embroidering screen and thread the upper threads. (page 61)

10 Start embroidering. (page 67)

Frame patterns

1 Touch .

2 From the upper tabs, select the desired frame shape.

→ Frame patterns appear below.

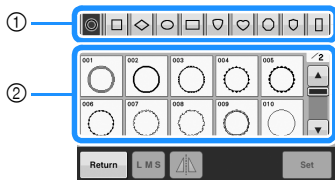

- ① Frame shapes
- ② Frame patterns

3 Touch the desired frame pattern.

→ The selected pattern appears in the pattern display area.

4 Touch .

→ The pattern editing screen appears.

5 Follow the procedure from step 4 to 10 of "Embroidery patterns" on page 29.

Monogram and frame designs

Monograms can be created by combining two or three letters with frame patterns.

1 Touch .

2 Touch the button for the desired character style.

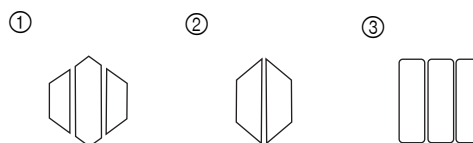
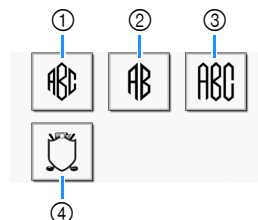

→ The text input screen appears.

- If ④ is selected, the frame pattern list appears. When creating a pattern by combining letters with a frame, it does not matter which is selected first. The embroidering order follows the order in which the parts of the monogram are selected. For this example, we will select the letters first.

3 Select the characters.

Touch the tabs to select different character shapes, and then touch the key for one letter on each tab.

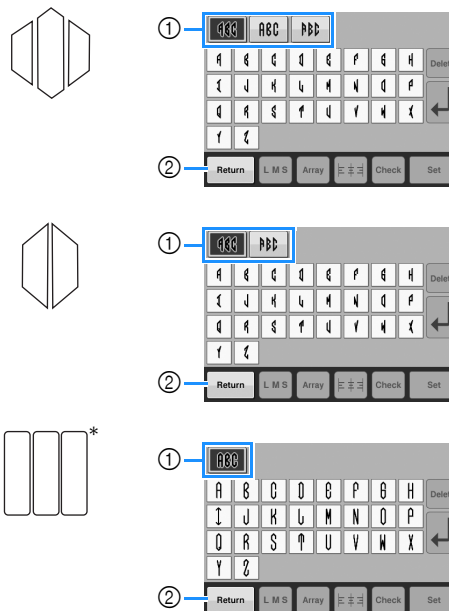

* Since the shapes of the letters are the same with this design, there are no tabs to select.

- ① Tabs
- ② To change the character font, touch  to return to the design selection screen.

→ The selected characters appear in the pattern display area.

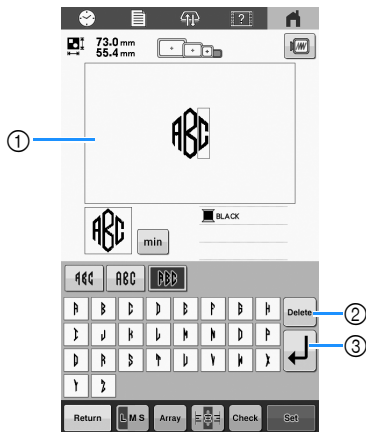

- ① Pattern display area
- ② Delete the characters.
- ③ Line feed key

Memo

- Depending on the monogram style, there is a preset number of letters; however, more than two or three letters can be entered. If too many letters are selected, touch **Delete** to delete the letters.
- Entered letters can be used in the same way as any other character pattern without creating a monogram.

4 If necessary, edit the characters. (page 32)

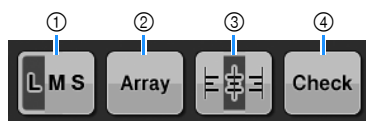

- ① Change the size of the characters.
- ② Change the text arrangement.
- ③ Change the text alignment.
- ④ Check the input texts.

5 Touch **Set**.

→ The pattern editing screen appears. Next, we will combine the letters with a frame.

6 Touch **Add**.



→ The pattern type selection screen appears.

7 Touch

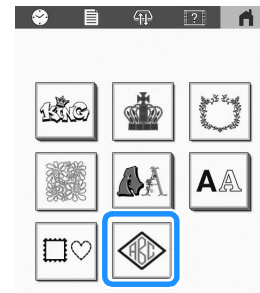

→ The design selection screen appears.

8 Touch



→ The list of frame patterns appears.

9 Touch the desired pattern.

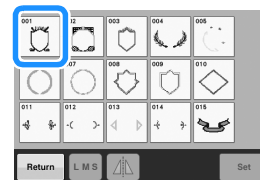

→ The selected frame pattern appears in the pattern display area.

10 Touch **Set**.

→ The pattern editing screen appears.

Memo

- Due to size or shape, some frame patterns cannot be used with the design.
- These frame patterns can also be combined with character patterns other than monograms.

11 Follow the procedure from step **4** to **10** of "Embroidery patterns" on page 29.

Character patterns



(page 22):
An instruction video is available for this topic.

1 Touch **AA**.

2 Touch the desired character font.

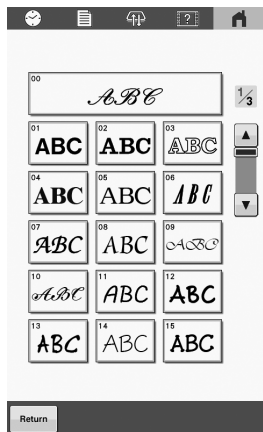

• Touch or for additional selections.
→ The text input screen appears.

3 Select the character category and then select the characters.

• For details, refer to “Character pattern input keys” below.



4 Touch **Set**.

→ The pattern editing screen appears.

5 Follow the procedure from step 4 to 10 of “Embroidery patterns” on page 29.







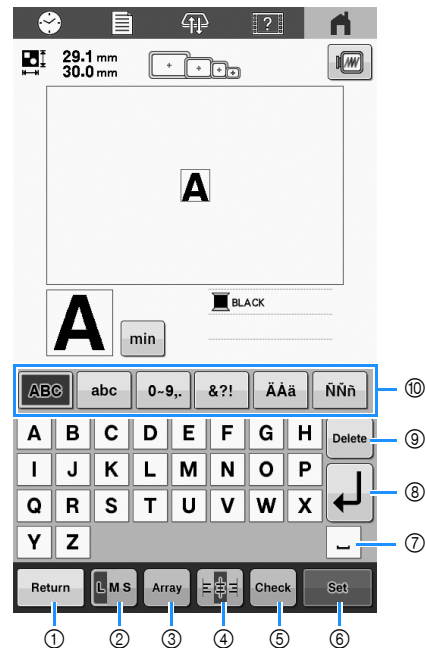





Character pattern input keys

Memo

- If a key display is grayed out, you cannot use that function with the selected pattern.



No.	Display Key Name	Function
①	 Return key	Return to the previous screen.
②	 Size key	Change the size of the character patterns. The size of the selected character is changed. <ul style="list-style-type: none"> • Depending on the font, it may not be possible to change the size.
③	 Array key	Change the layout of the character patterns. <ul style="list-style-type: none"> • To arrange the character patterns on an arc, touch , , or . : Make the arc flatter. : Make the arc rounder. • To arrange the character patterns on an incline, touch . : Change the incline counterclockwise. : Change the incline clockwise. • : Reset the layout.

No.	Display	Function
	Key Name	
④		Switch alignment. This function is available when multiple lines of characters are input. <ul style="list-style-type: none">  : Right alignment  <ul style="list-style-type: none">  : Left alignment  <ul style="list-style-type: none">  : Center alignment 
	Alignment key	
⑤		Check the entered text when it is small and difficult to read on the screen.
	Character check key	
⑥		Apply the character pattern editing to go to the editing screen.
	Set key	
⑦		Enter a space.
	Space key	
⑧		Make a new line.
	Line feed key	
⑨		Delete the character.
	Delete key	
⑩	—	Select the category of character.
	Category keys	

Decorative alphabet patterns

1 Touch .

2 Touch the desired category.

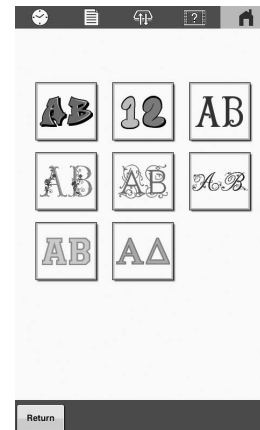

3 Touch the desired pattern.



①

① Flip the pattern horizontally, if desired.

→ The selected pattern appears in the pattern display area.

4 Touch .

→ The pattern editing screen appears.

5 Follow the procedure from step 4 to 10 of "Embroidery patterns" on page 29.

■ Appliqué alphabet

1 Touch .

2 Touch .

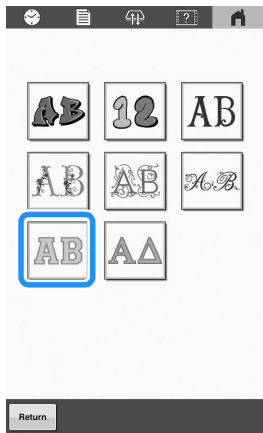

→ The list of appliqué alphabets appears.

3 Touch the desired pattern.

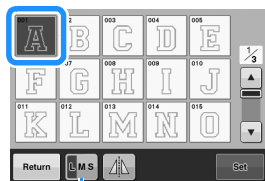

①

① Change the character size.

→ The selected pattern appears in the pattern display area.

4 Touch .

→ The pattern editing screen appears.

Note

- For details on embroidering appliqués, refer to “Embroidering appliqué patterns” on page 74.

Combining patterns

Example:



1 Select a pattern and then touch .

2 Touch .



3 Touch .

4 Select  and enter “LOVE”.

→ The characters you enter will be displayed in the center of the embroidery pattern area.

5 Touch .

6 Use  to move the characters.

* Characters can also be moved by directly dragging them with your finger or the touch pen.

7 Touch  to change the color of the characters.
(page 42)

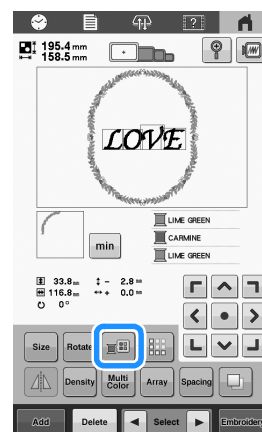



8 Touch .

9 When all editing is finished, touch .

 **Memo**

- Combined patterns will be embroidered in the order they were entered.

■ **Selecting the pattern to be edited**

If multiple patterns have been combined, use  or  to select the pattern to be edited. Patterns can also be selected by directly touching the screen with your finger or touch pen.

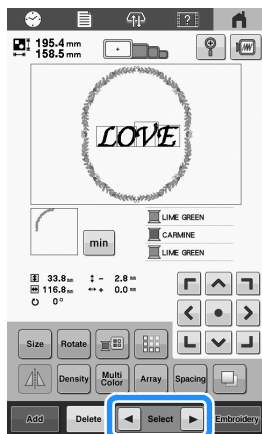



EDITING THE EMBROIDERY PATTERN

Understanding the pattern editing screen

 **Memo**

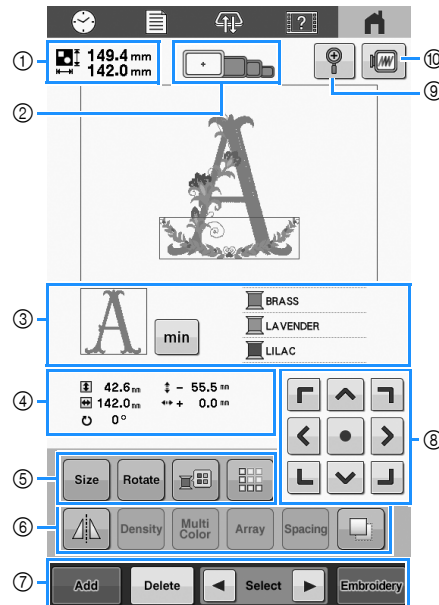











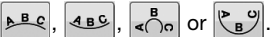
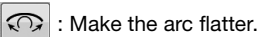





- If a key display is grayed out, you cannot use that function with the selected pattern.













No.	Display	Function	Page
	Key Name		
①	 149.4 mm 142.0 mm	Shows the size of the embroidery pattern currently displayed in the pattern display area. The top value shows the height and the bottom value shows the width. If the embroidery pattern consists of multiple patterns that have been combined, the size will include all patterns.	—
②	 Embroidery frame indicators	Shows the sizes of embroidery frames that can be used to embroider the pattern currently displayed in the pattern display area.	48

No.	Display	Function	Page
	Key Name		
③		Shows the part of the pattern that will be embroidered with the thread color shown first in the thread color sequence display.	—
	Region display		
		Change the thread color sequence display to embroidering time of each thread colors.	—
	Thread information (color/time)		
		Shows the order for the thread color changes. During embroidering, this display scrolls automatically so that the color of the thread currently being embroidered appears at the top. The displayed information can be switched between the thread color name and the embroidery thread number. (page 84)	—
Thread color sequence display			
④		Shows the size of the pattern being edited. The top value shows the height and the bottom value shows the width.	—
	Size		
		Shows the vertical distance that the pattern being edited is moved.	—
	Distance from center (vertical)		
		Shows the horizontal distance that the pattern being edited is moved.	—
	Distance from center (horizontal)		
	Shows the rotation angle that the pattern being edited is rotated.	—	
Rotation angle			

No.	Display	Function	Page		
	Key Name				
⑤		Display the pattern sizing window. <ul style="list-style-type: none"> : Decrease the pattern proportionately. : Decrease the pattern vertically. : Decrease the pattern horizontally. : Enlarge the pattern proportionately. : Stretch the pattern vertically. : Stretch the pattern horizontally. : Select the pattern that you want to change. : Move the pattern in the direction shown by the arrow. : Reset the size. : Close this screen. 	—		
	Size key				
				Display the pattern rotating window. <ul style="list-style-type: none"> : Reset the angle. Rotate the pattern using the rotate key. You can also use the move keys during the rotation process.	—
	Rotate key				
				Change the color of the pattern.	42
				Make and edit the repeated pattern.	38
	Change thread color key				
	Border key				

No.	Display Key Name	Function	Page
⑥		Change the pattern to a horizontal mirror image.	—
	Horizontal mirror image key		
		Change thread density for some character and frame patterns.	38
	Density key	Enable the thread color of each character in a character pattern to be changed; can only be used when a character is selected.	42
			
	Multi color key	Change the layout of the character patterns. <ul style="list-style-type: none"> To arrange the character patterns on an arc, touch  or . : Make the arc flatter. : Make the arc rounder. To arrange the character patterns on an incline, touch . : Change the incline counterclockwise. : Change the incline clockwise. : Reset the layout. 	—
			
	Array key		
	 : Change the spacing of the character patterns. <ul style="list-style-type: none"> : Increase the character spacing. : Decrease the character spacing. : Reset the spacing. 	—	
Character spacing/Text dividing key			
	Separate the continuous character patterns to adjust the spacing or edit separately afterwards. <ul style="list-style-type: none"> : Select where the patterns is to be separated. : Separate the pattern. 	—	
			
Duplicate key	Duplicate the pattern. The duplicated pattern will be positioned slightly lower and to the right from the original pattern.	—	

No.	Display Key Name	Function	Page
⑦		Add a pattern. If touched, the pattern type selection screen appears.	34
	Add key		
		Deletes the pattern. If touched, the pattern being edited is deleted.	—
	Delete key		
		Selects the pattern that is being edited when the embroidery pattern consists of multiple patterns that have been combined.	35
Pattern selection keys			
	Finish editing and continue to the embroidering screen.	—	
⑧		<ul style="list-style-type: none"> : Move the pattern in the direction shown by the arrow. : Move to the center of the embroidering area. 	34
	Positioning keys		
⑨		Enlarge the pattern view up to 200%. 	—
	Enlarge key	When enlarged,  appear in the screen. Touch one of the keys that appeared to move the display area in the corresponding direction, making this convenient for checking pattern details. You can continue editing at 200% magnification.	
⑩		Display an image of the pattern so that it can be previewed.	47

Changing the thread density (only for some character and frame patterns)

The thread density for some character and frame patterns can be changed.

A setting between 80% and 120% in 5% increments can be specified.

- 1 Touch .



→ The screen shown below appears.

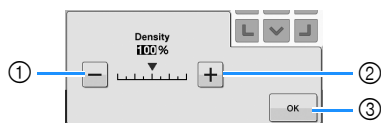

- ① Make the pattern less dense.
- ② Make the pattern more dense.
- ③ Close this screen.

■ Selects a less/more thread density



- 1 Touch the keys to select the desired thread density.
Each touch of a key slightly increases or decreases the thread density.
 - To return to the original thread density (standard), select [100%].

- 2 After making the desired changes, touch .

Designing repeated patterns

Using the border function, you can create an arrangement using repeated patterns.

- 1 Select the pattern that you want to repeat and touch .

- 2 Touch .





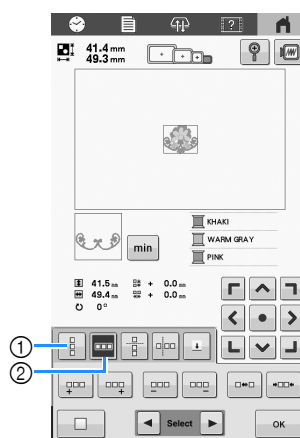

- 3 Select the direction in which the pattern will be repeated.



- ① Vertical direction
- ② Horizontal direction



→ The pattern direction indicator will change depending on the direction selected.

- 4 Use  to repeat the pattern on the left and  to repeat the pattern on the right.

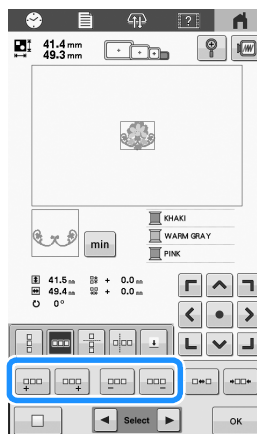
- To delete the left pattern, touch .
- To delete the right pattern, touch .



5 Adjust the spacing of the repeated pattern.

- To widen spacing, touch .
- To tighten spacing, touch .

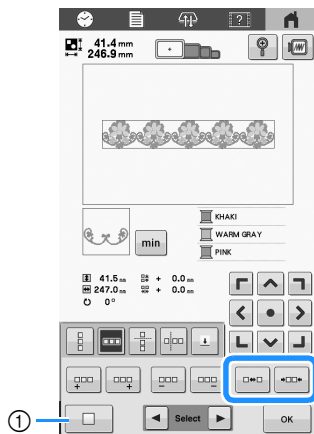

- ① Touch  to change a repeated pattern back to one single pattern.

Memo

- You can only adjust the spacing of patterns included in the red frame.

6 Complete repeated patterns by repeating steps 3 through 5.

7 After making the desired changes, touch .

Memo

- When there are two or more patterns, all patterns will be grouped together as one pattern in the red frame.

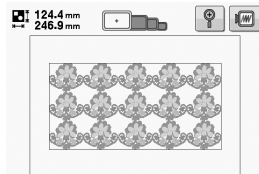



- When changing the direction in which the pattern will be repeated, all of the patterns in the red frame will automatically be grouped as one repeating unit.

Repeating one element of a repeated pattern

By using the Cut function, you can select one element of a repeated pattern and repeat only that single element. This function allows you to design complex repeated patterns.

1 Choose the direction in which the repeated pattern will be cut.

- Touch  to cut horizontally.
- Touch  to cut vertically.

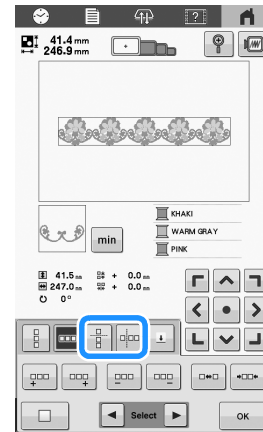

→ The pattern direction indicator will change depending on the direction selected.

2 Use  and  to select the cut line.

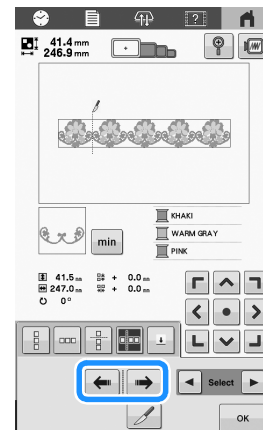

→ The cut line will move.

3 Touch .

→ The repeated pattern will be divided into separate elements.

4 Touch .

5 Use and to select the element to repeat.

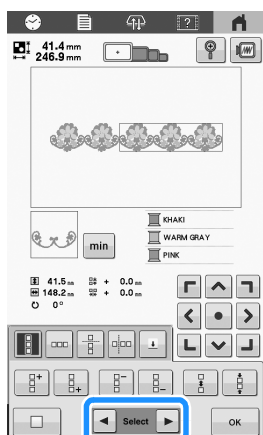

6 Repeat the selected element.

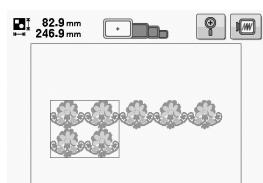

7 After making the desired changes, touch .

Memo

- Once you have cut a repeated pattern into separate elements, you cannot return to the original repeated pattern.
- Each element can be edited separately in the edit screen. Refer to “Selecting the pattern to be edited” on page 35.

■ Assigning thread marks

By embroidering thread marks, you can easily align patterns when embroidering a series. When embroidery is finished on a pattern, a thread mark in the shape of an arrow will be embroidered using the final thread. When embroidering a series of patterns, use the point of this arrow for positioning the following designs to be embroidered.

Memo

- When repeatedly embroidering individual patterns, thread marks can be embroidered around the perimeter of the pattern only.

1 Touch .

2 Touch .

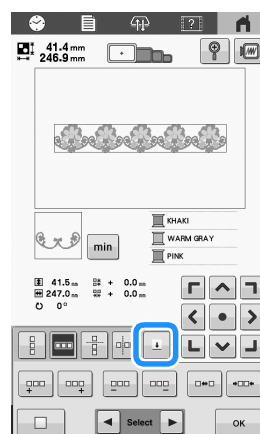

3 Touch to select the thread mark to be embroidered.

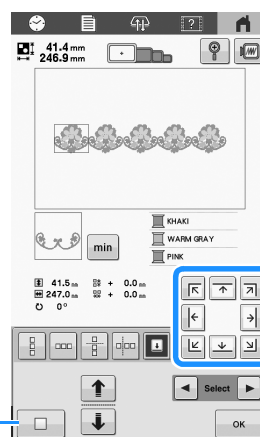

① Touch to cancel thread mark setting.

Memo

- When there are two or more elements, use and or and to select a pattern that you want to assign a thread mark(s) to.

4 Touch .

Memo

- If the combined border pattern is rotated in the embroidering screen, the thread mark will be removed.

■ Embroidering the pattern repeatedly

After creating the repeated pattern, rehoop the fabric in the embroidery frame and keep embroidering for the next pattern.

- 1 Create the repeated pattern with the thread mark at the center of the end of the pattern. (page 40)

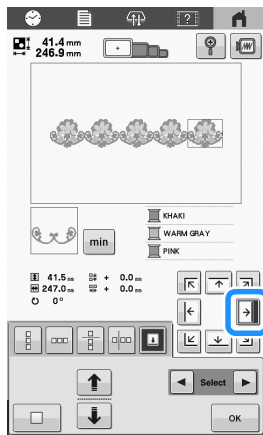

- 2 Touch **OK**, then **Embroidery**.
- 3 Touch **Lock**, and then press the "Start/Stop" button to start embroidering.

→ When embroidering is finished, the thread mark is embroidered with the last thread color.



- 4 Remove the embroidery frame.
- 5 Rehoop the fabric in the embroidery frame.

💡 Note

- Adjust the position of the fabric so that the embroidering area for the next pattern is within the embroidering area of the embroidery sheet.

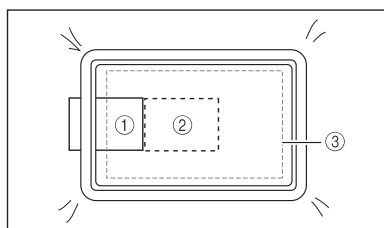

- ① Pattern embroidered first
- ② Position of pattern to be embroidered next
- ③ Embroidering area of embroidery sheet

- 6 Attach the embroidery frame to the machine, and then touch in the embroidering screen.

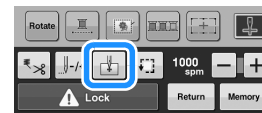

- 7 Touch to set the starting point to the left side of the pattern.

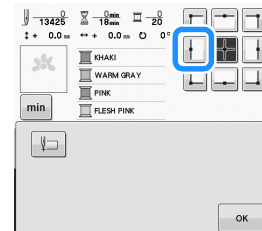

- 8 Touch **OK**.
- 9 Align the needle drop point with the thread mark on the fabric.
- 10 If the pattern position cannot be aligned using the positioning keys, rehoop the fabric, and then try again to align the position with the positioning keys.

💡 Note



- After you have aligned the position of the combined border pattern, do not rotate the pattern in the embroidering screen. If the pattern is rotated in the embroidering screen after alignment, the pattern will not be properly aligned with the thread mark or starting point.

- 11 Remove the stitched thread mark.
- 12 Touch **Lock**, and then press the "Start/Stop" button to start embroidering.

EDITING COLORS

Specifying multi-color text

The alphabet pattern characters selected on page 32 are set to black. The color of the characters can be changed using the change thread color key; however, to change the color of individual characters, touch the Multi Color key to turn it on, and then specify the color for each character.

1 Touch  so that it changes to .



- Each touch of the key turns the setting either on or off.

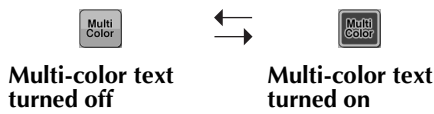

- For details on changing the thread color, refer to “Changing the colors of the pattern” below.

Changing the colors of the pattern

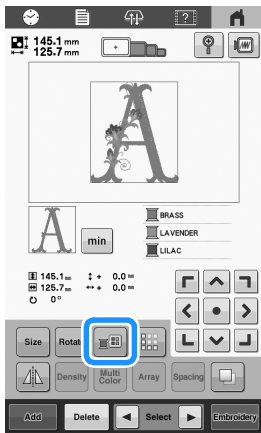

1 Touch .

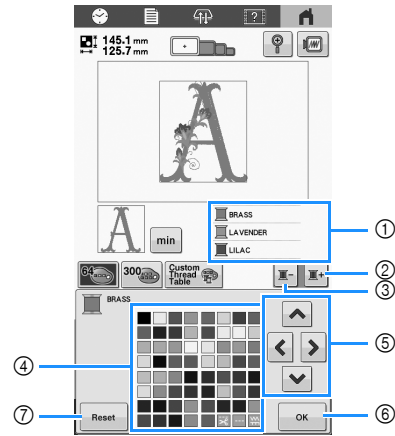

→ The change thread color screen appears.



- ① The part of the pattern in the color at the top of the thread color sequence display is the part whose color is being changed.
- ② Selects the next color in the thread color sequence display.
- ③ Selects the previous color in the thread color sequence display.
- ④ Color thread table
Select a color from this table.
- ⑤ Use these keys to select a color from the color thread table.
- ⑥ Close this screen.
- ⑦ Return to the original color.

2 Touch  or  until the color to be changed appears at the top of the thread color sequence display.

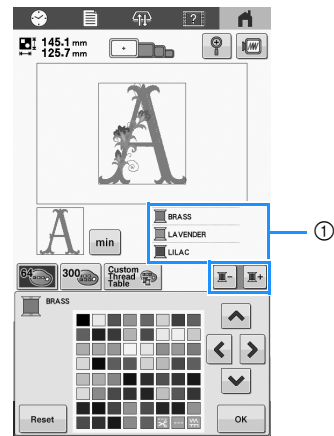

- ① The thread color for the part of the pattern displayed at the top will be changed.

- 3 Touch , , or , or directly touch the desired color, to select the new color from the color palette.

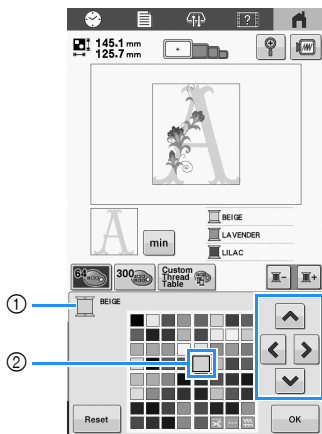

- ① Displays the name of the selected thread color.
 - ② The color that appears enlarged is the color that is selected.
- In the pattern display area, the color of the selected part of the pattern is changed.

- 4 Touch .

- The color change is confirmed.
- The pattern editing screen appears again.

Memo

- The color thread table can be changed to a custom thread table that you create to reflect the thread colors that you have. For details, refer to “Creating a custom thread table” below.

Creating a custom thread table

You can create a custom thread table containing the thread colors that you most often use. You can select thread colors from the machine’s extensive list of thread colors from nine different thread brands.

Before creating a custom thread table, select a pattern and display the pattern editing screen.

- 1 Touch , and then touch .

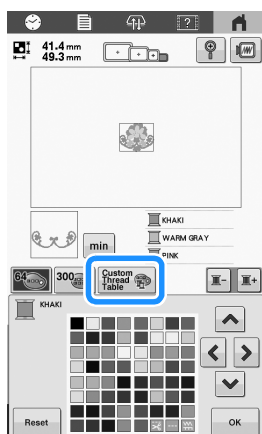

- 2 Use , , or to select where to add a color on the custom thread table.

- You can select the color box from the custom thread table by directly touching the screen.
- You can scroll through 100 colors at a time using and on the custom thread table.

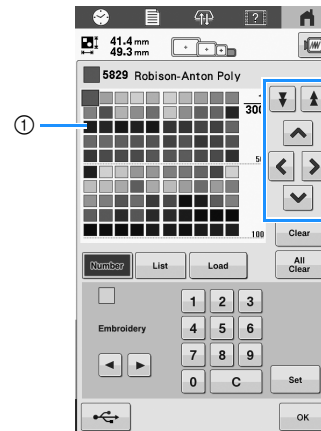

- ① Custom thread table

- 3 Use or to select one of the thread brands in the machine.

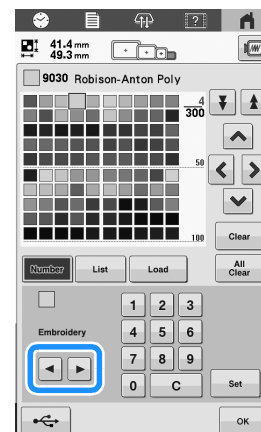

- 4 Use , , , , , , , , and to enter a color’s 4-digit number.

- If you make a mistake, touch to erase the entered number, and then enter the correct number.

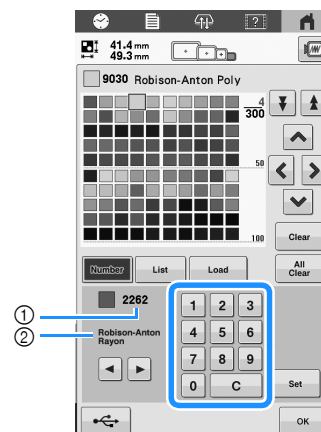

- ① Entered thread color number
- ② Thread brand

5 Touch **Set**.

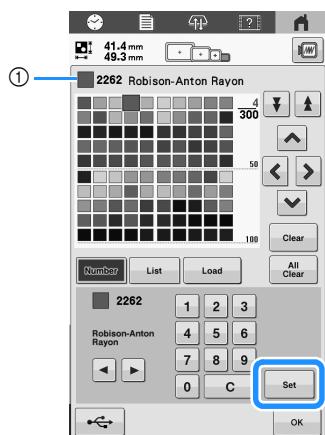

① Selected thread color

→ The selected thread color is set in the custom thread table.

6 Repeat the previous steps until all desired thread colors are specified.

- To delete a specified color from the custom thread table, touch **Clear**.
- To delete all the specified color from the custom thread table, touch **All Clear**.

Note

- When setting up a custom thread table, touch **▲**, **◀**, **▶** or **▼** or touch the next square directly to set the next color after each selection. The machine will not advance to the next square automatically.

7 Touch **OK** to return to the original screen.

■ Adding a color to the custom thread table from the list

1 Touch **Custom Thread Table**, and then touch **Custom Thread Table**.

2 Touch **List** to display the thread list.

3 Use **▲** or **▼** to select a thread color.

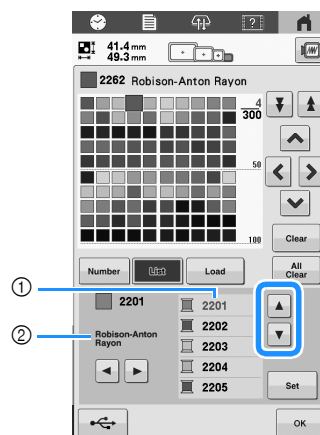

① Thread color numbers

② Thread brand

4 Touch **Set**.

5 Repeat the previous steps until all desired thread colors are specified.

6 Touch **OK** to return to the original screen.



Selecting a color from the custom thread table

You can select a color from the up to 300 thread colors you have set in the custom thread table.

1 Touch .



→ The 64 embroidery threads table screen displays.

2 Touch  or  to select the thread color you want to change.

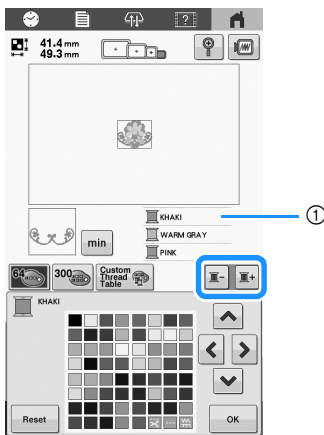





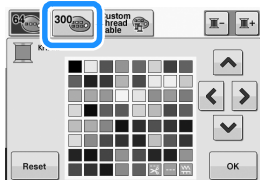

① The thread color displayed at the top is being selected.

3 Touch .



→ The custom thread table (300 embroidery threads table) screen will appear.

4 Touch , ,  or  to select a new color from the custom thread table.

- Use  and  to scroll through the custom thread table.
- Touch  to return to the original color.
- You can select colors from the custom thread table (300 embroidery threads table) by directly touching the screen.

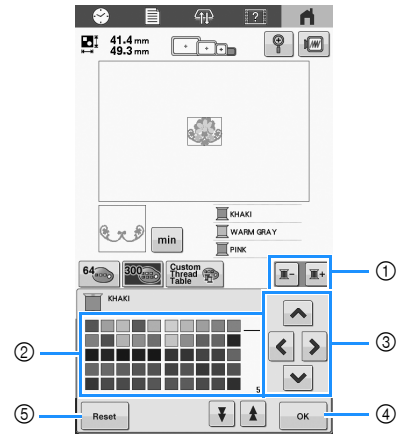

- ① Select the thread color you want to change.
- ② Color thread table
Select a color from this table.
- ③ Use these arrows to select the color within the color thread table.
- ④ Close this screen.
- ⑤ Return to the original color.

→ The display shows the changed colors.

5 Touch .



Saving and retrieving the custom thread table

You can save a custom thread table data file to USB media, and then you can retrieve the saved data from USB media again.

Memo

- Custom thread table data can only be saved to USB media. You cannot save the data in the machine's memory or in the computer.
- Custom thread table data is saved as “.pcp” data file.

■ Saving the custom thread table to USB media

- 1 Insert the USB media into the USB port on the machine.
- 2 Touch , and then touch  in the pattern editing screen.
- 3 Touch .

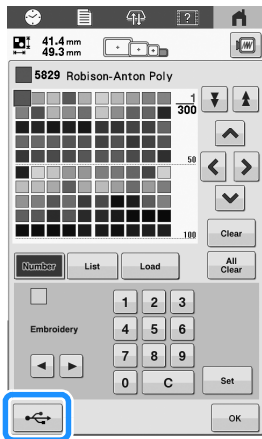

→ The [Saving...] screen is displayed. When the data is saved, the display returns to the original screen automatically.

Note

- Do not insert or remove USB media while the [Saving...] screen is displayed. You will lose some or all of the data you are saving.

■ Retrieving the custom thread table data from USB media

- 1 Insert the USB media containing the custom thread table data into the USB port.

Note

- You can only retrieve one custom thread table data at a time. Do not save two or more “.pcp” data files in USB media.

- 2 Touch , and then touch  in the pattern editing screen.

- 3 Touch .

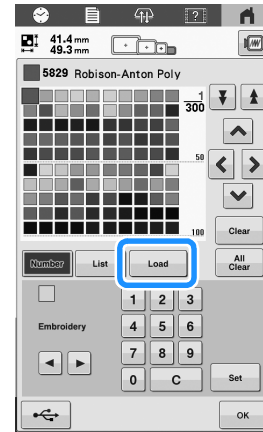

→ The [Saving...] screen is displayed. When the data is loaded to the machine, the display returns to the original screen automatically.

Note

- Do not insert or remove USB media while the [Saving...] screen is displayed. You will lose some or all of the data you are saving.
- To delete the custom thread table that was loaded, touch . All the specified colors will be deleted.

PREVIEWING THE IMAGE



Checking a preview image

Display the preview image to check that the embroidery will be performed as desired.

- 1 Touch .



→ The preview image is displayed.

- 2 Touch  or  to display the desired type of frame, and then select the embroidery frame. Touch  to fill the screen with just the pattern.

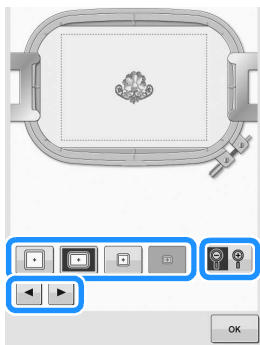

- After determining the type of Embroidery Frame Holder and size of embroidery frame that are best for your embroidery, change the Embroidery Frame Holder and embroidery frame that are installed. The machine will automatically detect the Embroidery Frame Holder and embroidery frame and change the display.
- Touch  again to also display the embroidery frame.

- 3 Touch  to return to the previous screen.

Memo

- Embroidering can be started while the preview image is displayed in the embroidering screen. If the preview image is displayed in any screen other than the embroidering screen, embroidering cannot be started.

PREPARING THE FABRIC

CAUTION

- Your machine can embroider fabric that is up to 2 mm (approx. 5/64 inch) thick. If thicker fabric is embroidered, the needle may break and cause injury.

Attaching stabilizer (backing) to fabric

In order to prevent shrinkage of the stitching or misaligned patterns, we recommend that stabilizer (backing) be used for embroidering.

CAUTION

- When embroidering on thin or stretch fabrics, fabrics with a coarse weave or fabrics that easily allow the stitching to shrink, be sure to use stabilizer (backing) for embroidering. Not using a stabilizer (backing) may cause the needle to break and cause injury.

- 1 Using a steam iron, affix the iron-on stabilizer (backing) to the back of the fabric.

- Use a piece of stabilizer which is larger than the embroidery frame being used.

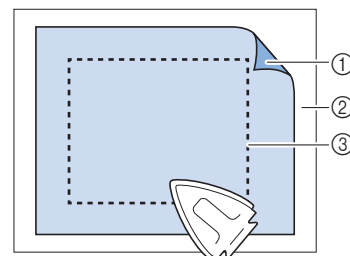

- ① Adhesive side of iron-on stabilizer (backing)
- ② Fabric (wrong side)
- ③ Size of the embroidery frame

Memo

- When embroidering light or open designs on thin fabrics, such as organza or lawn, use a water-soluble stabilizer (backing). Water-soluble stabilizers dissolve when washed, allowing you to create beautiful embroidery that is not stiff.
- When embroidering fabric that should not be ironed or when embroidering an area that is difficult to iron, hoop a layer of the stabilizer (backing) under the fabric in the embroidery frame without ironing it.

Fabric/stabilizer compatibility chart

Fabric/ Garment	No. of Backing Pieces	No. of Topping Pieces
	Comments	
Terry cloth	1 tear-away	1 water-soluble
	Increase density and/or satin stitch width. Fine details and small lettering tend to get caught in the terry loops.	
Satin jacket	Heavy lining: None Light or no lining: 1 tear-away	None
	If garment slips in frame, causing alignment problems, wrap inner frame with masking tape or fabric bias tape. This provides a rough surface to grip garment and also helps minimize frame burn.	
Cotton sheeting	1 tear-away	None
	High-density or highly detailed designs may require more backing. If so, use two pieces of lightweight backing instead of one piece of heavy backing.	
Denim	1 tear-away	None
	Reduce speed if needle begins to heat up and the thread breaks.	
Headwear	Optional	Optional
	Change needles more often than usual because the buckram backing dulls needles faster. A lightweight tear-away backing helps reduce thread breaks and regulates thread tension. Use a topping on corduroy or foam cap fronts.	
Dress shirt (woven)	1 tear-away	None
	High-density or highly detailed designs may require more backing. If so, use two pieces of lightweight backing instead of one piece of heavy backing.	
Golf shirt	1 cut-away or iron-on cut-away	Optional
	Use topping for designs containing small lettering or a lot of detail, and also for piqué knits.	
Canton fleece	1 tear-away	Optional
	Use a topping if the garment has a textured surface, such as a basketweave or pronounced twill.	
Canvas	1 tear-away	None
	Frame tightly.	

Fabric/ Garment	No. of Backing Pieces	No. of Topping Pieces
	Comments	
Corduroy	1 tear-away	1 water-soluble
	A higher stitch density or more under stitches, as well as a topping, may be necessary to prevent stitches from sinking into the fabric.	
Lingerie or silk	1 or 2 lightweight tear-away	Optional
	Reduce embroidery speed. The thread tension should be low. Use topping for designs with high detail or small lettering. For very fine fabrics, use a thinner thread. Avoid extremely narrow satin stitching on letters or details; instead increase satin stitch width or use a bean stitch. Gently remove (don't pull) backing and topping from garment.	
Sweater knit	1 cut-away or iron-on cut-away	1 water-soluble
	Use tightly woven organza or curtain fabric in a matching color as a backing for bulky or "holey" knits.	
Sweatshirt	1 cut-away or adhesive tear-away	Optional
	Highly detailed designs may require two layers of lightweight cut-away stabilizer. Use a topping on extra-thick fabrics or with fine-detail designs.	
T-shirt	1 light-weight cut-away or iron-on cut-away	Optional
	Use a topping on designs with fine detail or small lettering. Tensions should be light. Avoid stitch-heavy designs.	

Note

- Due to the wide variety of fabrics and stabilizers available, the above information should be used as guideline only. If unsure of a particular fabric/stabilizer combination, please embroider a test sample prior to the finished garment.

Hoop the fabric in the embroidery frame

Note

- If the fabric is not taut, the pattern may be misaligned or the fabric may pucker. Follow the procedure described below to firmly smooth the fabric in the embroidery frame so that the fabric is not loose. In addition, be sure to work on a level surface when putting the fabric in the embroidery frame.

1 Select an embroidery frame.

From the sizes of embroidery frames indicated in the screen, select the embroidery frame that you wish to use.



Embroidery frames that can be used appear lighter (◻). Embroidery frames that cannot be used appear darker (◼).

Memo

- If the Embroidery Frame Holder is not attached to the machine, the available embroidery frame(s) will not be displayed correctly. (page 52)

When the [E OFF] is selected, the following embroidery frame indicators are displayed. (page 84)



Embroidery frame types

For details on the embroidery frames indicated in the screen, refer to “Types of embroidery frames/Embroidery Frame Holders and their applications” on page 53.

CAUTION

- If the size of the embroidery frame is wrong, the embroidery frame may hit the presser foot and damage the machine or cause injury to the user. (For details on embroidery frames, refer to page 53.)

IMPORTANT

- Use the included frames or recommended optional frames.

Note

- The embroidery frame indicators show all embroidery frame sizes in which the embroidery pattern can be embroidered. Be sure to use an embroidery frame of the most suitable size. If an embroidery frame that is too large is used, the pattern may be misaligned or the fabric may pucker. (page 53)

Hooping the fabric in the embroidery frame

1 Loosen the screw on the outer frame.

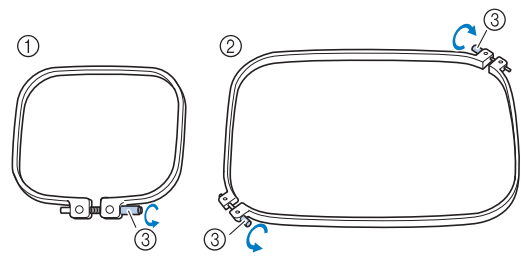

- ① Small (optional) and medium frame have one screw.
- ② Large (optional) and extra-large frame have two screws.
- ③ Screw

2 Place the stabilizer and fabric with right side up on top of the outer frame.

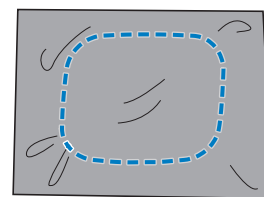

- The outer frame does not have a front or back side. Either side can be used as the front.

3 Press the inner frame into the outer frame.

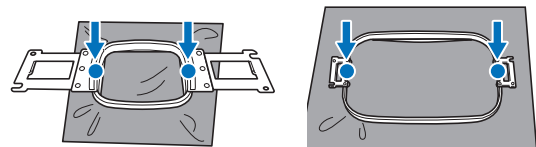

- Be sure that there are no wrinkles in the fabric after it is hooped in the embroidery frame.

4 Lightly tighten the screw.

- Align the inner and outer frames so that their tops are even.

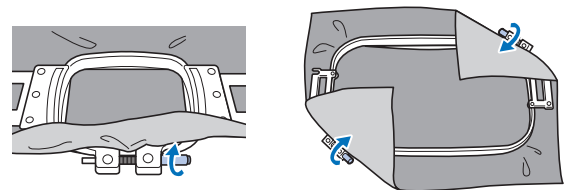

5 Securely tighten the screw, and then check to make sure that the fabric is taut.

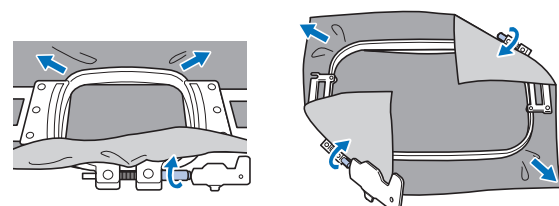

- Use the 3-way screwdriver to tighten the screw securely.
- After securing the fabric, lightly tapping it should produce a drum-like sound.

- Firmly clamp together the inner and outer frames so that their tops are even.

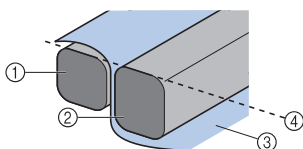

- ① Outer frame
- ② Inner frame
- ③ Right side of fabric
- ④ Top of inner and outer frames are even

Memo

- To correctly frame the fabric in the embroidery frame, we recommend using a flat surface.

■ Using the embroidery sheet

In order to hoop the fabric so that the pattern will be embroidered in the correct position, use the guidelines on the embroidery sheet to accurately align the fabric in the frame.



- With a fabric marker, mark the area of the fabric you want to embroider.

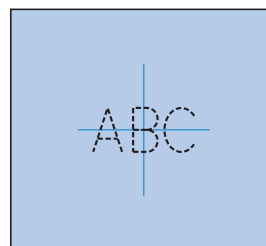

- Place the embroidery sheet on the inner frame. Align the guidelines on the embroidery sheet with the marks that you drew on the fabric.

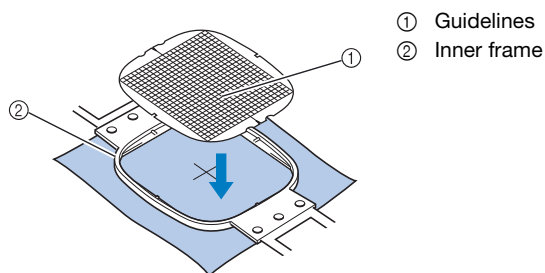

- Gently stretch the fabric, so that there are no folds or wrinkles.

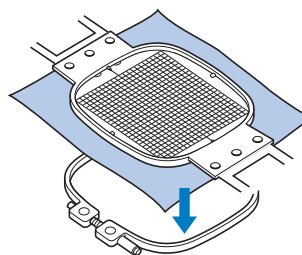

- Remove the embroidery sheet.

■ Embroidering large pieces of fabric or heavy clothing

When embroidering large pieces of fabric or heavy pieces of clothing, use a clothespin or binder clip to fasten the excess fabric to the embroidery frame so that it does not hang down from the frame. Embroidering with excess fabric hanging down from the embroidery frame may prevent the frame from moving properly and may result in a misaligned pattern.

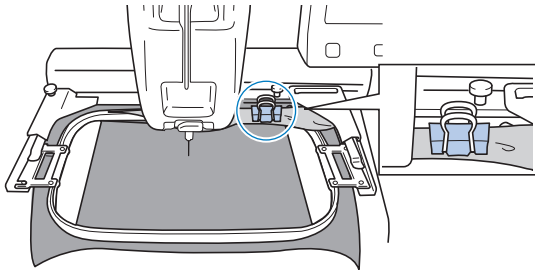

- Use a clothespin or binder clip to fasten the excess fabric to the embroidery frame.

Memo

- We recommend installing the optional wide table to support large and heavy clothing.

■ Embroidering small pieces of fabric

When embroidering small pieces of fabric that cannot be hooped in an embroidery frame, use stabilizer material as a base. After lightly ironing the fabric to the stabilizer material, hoop it in the embroidery frame. If stabilizer material cannot be ironed onto the fabric, attach it with a basting stitch. After completing the embroidery, remove the stabilizer material carefully.

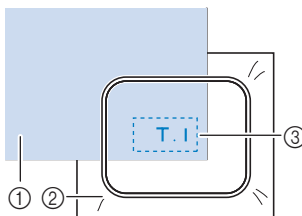

- ① Fabric
- ② Stabilizer (backing)
- ③ Basting

■ Embroidering items, such as bags and tubular items, that have limitations to being hooped in the embroidery frame

Rotate the pattern before embroidery. For details on rotating the pattern, refer to “Understanding the pattern editing screen” on page 35.

Example: When embroidering a pillowcase
Rotate the pattern 90 degrees to the left before embroidering.

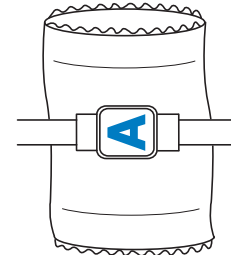

Example: When embroidering a T-shirt
Rotate the pattern 180 degrees. Pass the machine bed through from the waist of the T-shirt, not from the neck, and attach the embroidery frame to the machine. This will prevent the neck of the shirt from being stretched when the embroidery frame is moving.



ATTACHING THE EMBROIDERY FRAME TO THE MACHINE

After hooping the fabric in the embroidery frame, attach the frame to the machine. Embroidery Frame Holders A and B are included accessories with this machine. Install Embroidery Frame Holder A when an included embroidery frame is to be used. (For details on the Embroidery Frame Holders, refer to page 53.)

⚠ CAUTION

- If the embroidery frame is not correctly attached, it may hit the presser foot and damage the machine or cause injury to the user.
- When attaching the embroidery frame, make sure that the "Start/Stop" button is lit in red. If the "Start/Stop" button is flashing in green, the machine may start embroidering. If the machine accidentally starts operating, injuries may result.

IMPORTANT

- When attaching the embroidery frame, make sure that the embroidery frame does not hit any other part of the machine.

Attaching the embroidery frame

Adjust the width of the Embroidery Frame Holder to the size of the embroidery frame, and then attach the embroidery frame to the machine. As an example, the procedure for attaching the medium embroidery frame is described below.

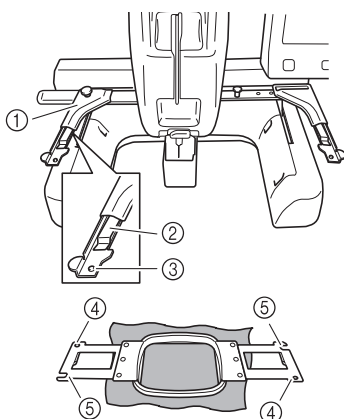

- ① Left arm of Embroidery Frame Holder
Move the arm of the Embroidery Frame Holder to the left or right to adjust it to the size of the embroidery frame.
- ② Clip on Embroidery Frame Holder
Insert the embroidery frame into the clips on the Embroidery Frame Holder.
- ③ Positioning pin
- ④ Holes
- ⑤ Positioning slots

1 Loosen the two left thumb screws on the Embroidery Frame Holder.

If the screw is too tight, please use the included 3-way screwdriver. (page 17)

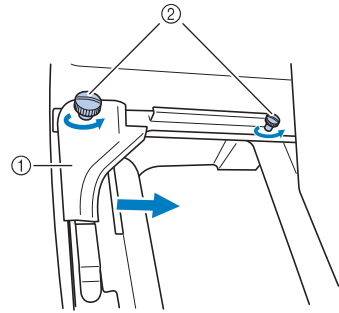

- ① Left arm
- ② Thumb screws

→ The left arm of the Embroidery Frame Holder can be moved.

- Only loosen the thumb screws a maximum of 2 turns counterclockwise. Do not remove the screw.

2 Move the left arm to align the screw on the right side with the mark for the embroidery frame to be installed, and then tighten the thumb screws.

For this example, align with mark ④.

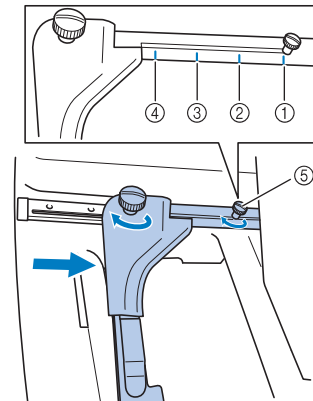

- ① Mark for extra-large embroidery frame
300 mm (W) × 200 mm (H)
(approx. 11-3/4 inches (W) × 7-7/8 inches (H))
- ② Mark for large embroidery frame (optional)
180 mm (W) × 130 mm (H)
(approx. 7-1/8 inches (W) × 5-1/8 inches (H))
- ③ Mark for medium embroidery frame
100 mm (W) × 100 mm (H)
(approx. 4 inches (W) × 4 inches (H))
- ④ Mark for small embroidery frame (optional)
60 mm (W) × 40 mm (H)
(approx. 2-3/8 inches (W) × 1-1/2 inches (H))
- ⑤ Align the screw with the mark.

💡 Note

- Please firmly tighten the two thumb screws with included 3-way screwdriver. If the thumb screws are not tightened, any of the following problems may occur.
 - The machine will detect the embroidery frame size incorrectly.
 - The starting position for the embroidery frame is misaligned.
 - The embroidery pattern is misaligned.

→ The Embroidery Frame Holder is ready for the embroidery frame to be attached.

- 3 Hold the embroidery frame level, and then simultaneously align both the left and right mounts with the Embroidery Frame Holder clips.

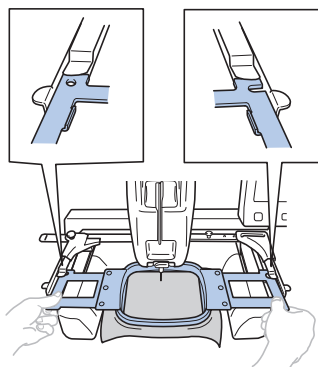

- The inner frame should be on top.

- 4 Insert the embroidery frame until it snaps into place.

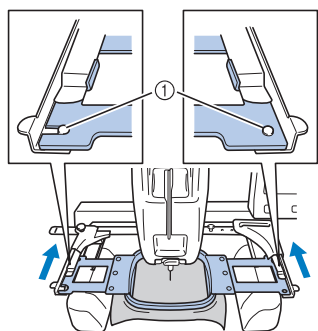

- ① Make sure that the pins on the left and right arms of the Embroidery Frame Holder fit into the positioning slot and hole on the embroidery frame.

Correctly using the embroidery frames

The various types of embroidery frames and their uses are described below.

In addition to the included embroidery frames, there are many frames that can be used with this machine.

CAUTION

- Only use embroidery frames of the sizes indicated in the screen, otherwise the embroidery frame may hit the presser foot, which may result in injuries.

When difficult to replace the embroidery frame

Depending on the situation at the end of stitching, it may be difficult to replace the embroidery frame. In that case, follow the procedure described below to move the embroidery frame.

- 1 Touch

- 2 When the message to move the carriage appears, touch



→ The carriage automatically moves to a position where the embroidery frame can easily be replaced.

- 3 After replacing the embroidery frame, touch

- 4 When the message displayed in step 2 appears, touch





→ The carriage returns to its original position.

Types of embroidery frames/Embroidery Frame Holders and their applications





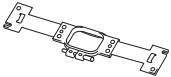

When the reference page is “*”, contact your authorized Brother dealer.

Embroidery frames that use Embroidery Frame Holder A

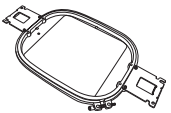

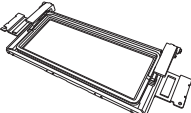

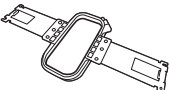
Embroidery frame	Embroidering area	
	Usage	
	Reference page	
Extra-large embroidery frame 	300 mm (W) × 200 mm (H) (approx. 11-3/4 inches (W) × 7-7/8 inches (H))	
	Use when embroidering connecting characters or patterns, combined patterns or large patterns. page 49	
Flat frame (optional) 	300 mm (W) × 200 mm (H) (approx. 11-3/4 inches (W) × 7-7/8 inches (H))	
	Use when embroidering jackets and other thick garments. When embroidering, install the optional wide table onto the machine. *	
Large embroidery frame (optional) 	180 mm (W) × 130 mm (H) (approx. 7-1/8 inches (W) × 5-1/8 inches (H))	
	Use when embroidering patterns with a size less than 180 mm (W) × 130 mm (H) (approx. 7-1/8 inches (W) × 5-1/8 inches (H)). page 49	
Medium embroidery frame 	100 mm (W) × 100 mm (H) (approx. 4 inches (W) × 4 inches (H))	
	Use when embroidering standard-sized patterns. page 49	

Embroidery frame	Embroidering area	
	Usage	
	Reference page	
Small embroidery frame (optional) 	60 mm (W) × 40 mm (H) (approx. 2-3/8 inches (W) × 1-1/2 inches (H))	
	Use when embroidering small-sized patterns, such as name tags.	
	page 49	





Embroidery frames that use Embroidery Frame Holder B

Embroidery frame	Embroidering area	
	Usage	
	Reference page	
Quilt frame (optional) 	200 mm (W) × 200 mm (H) (approx. 7-7/8 inches (W) × 7-7/8 inches (H))	
	Use when embroidering pieces for quilts. When embroidering, install the optional wide table onto the machine.	
	*	
Border frame (optional) 	300 mm (W) × 100 mm (H) (approx. 11-3/4 inches (W) × 4 inches (H))	
	Use when embroidering a long string of characters or patterns. When embroidering, install the optional wide table onto the machine.	
	*	
Sleeve frame (optional) 	70 mm (W) × 200 mm (H) (approx. 2-3/4 inches (W) × 7-7/8 inches (H))	
	Use when embroidering long items such as shirt sleeves.	
	*	







Embroidery frames that use Embroidery Frame Holder C (optional)

Embroidery frame	Embroidering area	
	Usage	
	Reference page	
Round frame (optional) ∅=diameter 	∅160 mm (approx. 6 inches) ∅130 mm (approx. 5 inches) ∅100 mm (approx. 4 inches)	  
	Use when adding a built-in embroidery pattern to a sleeve. Select the frame appropriate for the size of the pattern.	
	*	

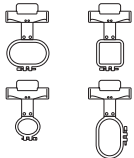

Embroidery frames that use Embroidery Frame Holder D (optional)

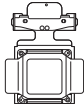
Embroidery frame	Embroidering area	
	Usage	
	Reference page	
Clamp frame S (optional) 	45 mm (W) × 24 mm (H) (approx. 1-3/4 inches (W) × 7/8 inches (H))	
	Use when embroidering specialty shaped items that cannot be held in normal frames, such as shoes and gloves.	
	*	
Clamp frame M (optional) 	100 mm (W) × 100 mm (H) (approx. 4 inches (W) × 4 inches (H))	
	Use when embroidering specialty shaped items, such as narrow bags.	
	*	





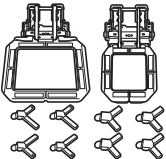

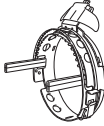

Embroidery frames that use Embroidery Frame Holder E (optional)

Embroidery frame	Embroidering area	
	Usage	
	Reference page	
Compact frame (optional) 	70: 70 mm (W) × 41 mm (H) (approx. 2-3/4 inches (W) × 1-5/8 inches (H)) 50: 50 mm (W) × 50 mm (H) (approx. 2 inches (W) × 2 inches (H)) 44: 44 mm (W) × 38 mm (H) (approx. 1-3/4 inches (W) × 1-1/2 inches (H)) Vertical: 33 mm (W) × 75 mm (H) (approx. 1-5/16 inches (W) × 2-15/16 inches (H))	   
	Use when embroidering logos or patterns on small items. *	
Magnetic frame (optional) 	50 mm (W) × 50 mm (H) (approx. 2 inches (W) × 2 inches (H))	
	Use to prevent the embroidery frame from leaving traces in the fabric. *	

Embroidery frames that use Embroidery Frame Holder F (optional)

Embroidery frame	Embroidering area	
	Usage	
	Reference page	
Versatile magnetic frame (optional) 	180 mm (W) × 130 mm (H) (approx. 7-1/8 inches (W) × 5-1/8 inches (H)) 100 mm (W) × 100 mm (H) (approx. 4 inches (W) × 4 inches (H))	 
	A variety of fabrics can be easily and firmly secured in the frame. *	

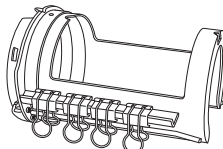
Embroidery frames that do not use Embroidery Frame Holders

Embroidery frame	Embroidering area	
	Usage	
	Reference page	
Cap frame (optional) 	130 mm (W) × 60 mm (H) (approx. 5-1/8 inches (W) × 2-3/8 inches (H))	
	Use when embroidering caps. Baseball (golf) caps, tulip hats and bucket hats can be embroidered with these frames. This frame cannot be used with hats having a front area of 50 mm (approx. 2 inches) or less, such as sun visors and children's hats. In addition, this frame cannot be used with hats that have a brim longer than 80 mm (approx. 3-1/8 inches). *	
Flat brim cap frame (optional) 	130 mm (W) × 60 mm (H) (approx. 5-1/8 inches (W) × 2-3/8 inches (H))	
	Use when embroidering caps. In addition to caps compatible with cap frame, this frame can be used to embroider flat brim caps and children's caps. Compared with cap frame, this frame can be used to embroider closer to the cap brim. *	
Magnetic sash frame (optional) 	360 mm (W) × 200 mm (H) (approx. 14 inches (W) × 7-7/8 inches (H)) Embroidery area: 300 mm (W) × 200 mm (H) (approx. 11-3/4 inches (W) × 7-7/8 inches (H))	
	Use when embroidering connecting characters or patterns, combined patterns or large patterns. When embroidering, install the optional wide table onto the machine. *	
Cylinder frame (optional) 	90 mm (W) × 80 mm (H) (approx. 3-1/2 inches (W) × 3 inches (H))	
	Use when embroidering tubular and curved fabric, such as shirt sleeves and turtlenecks. *	







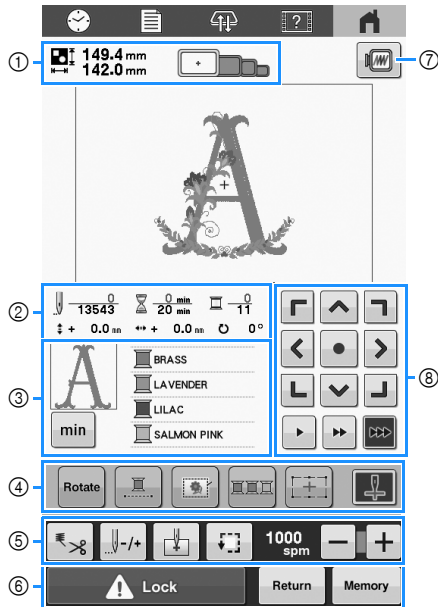



SPECIFYING EMBROIDERING SETTING













Understanding the embroidering screen



No.	Display Key Name	Function	Page
①	149.4 mm 142.0 mm	Shows the size of the embroidery pattern currently displayed in the pattern display area. The top value shows the height and the bottom value shows the width. If the embroidery pattern consists of multiple patterns that have been combined, the size of the entire pattern, including all patterns, is shown.	—
		Shows the embroidery frames that can be used to embroider the pattern currently displayed in the pattern display area. When the [E OFF] is selected, the embroidery frame indicators vary. (page 84)	—
②	13543	The bottom value shows the total number of stitches in the pattern and the top value shows how many stitches have already been embroidered.	—
	0 min 20 min	The bottom value shows the total amount of time required to embroider the pattern and the top value shows how much time has already passed embroidering.	—
	Embroidering time		—

No.	Display Key Name	Function	Page
②	0 11	The bottom value shows the total number of thread colors in the pattern and the top value shows the thread color that is currently being embroidered.	—
	+ 0.0 mm	Shows the vertical distance that the pattern being combined/edited is moved.	—
	+ 0.0 mm	Shows the horizontal distance that the pattern being combined/edited is moved.	—
	0°	Shows the rotation angle that the pattern being edited is rotated.	—
	Rotation angle		—
③		Shows the part of the pattern that will be embroidered with the thread color shown first in the thread color sequence display.	—
	min	Change the thread color sequence display to embroidering time of each thread colors.	—
		Shows the order for the thread color changes. During embroidering, this display scrolls automatically so that the color of the thread currently being embroidered appears at the top. The displayed information can be switched between the thread color name and the embroidery thread number. (page 84)	—
④	Rotate key	Rotate the entire embroidery pattern.	—
		Embroider the selected pattern with a single color (monochrome).	83
		When embroidering fabric that stabilizer cannot be attached to, embroider basting stitches around the pattern to prevent the stabilizer from moving. Stabilizer prevents shrinkage of the stitching and misaligned patterns.	73
	Embroidery basting key		73

No.	Display Key Name	Function	Page
④	 Color sorting key	Rearrange the stitching sequence for combined patterns by thread color.	59
	 Embroidery Crosshair Positioning Laser key	Align the pattern position using the Embroidery Crosshair Positioning Laser.	78
	 Embroidery Crosshair Positioning Laser on/off key	Switch on/off the Embroidery Crosshair Positioning Laser.	60
	 Thread trimming/cutting key	Specify automatic thread cutting or thread trimming.	58
⑤	 Forward/Backward stitch key	Move the needle forward or backward through the stitching. Use this key in the following situations: <ul style="list-style-type: none"> • If the thread breaks or runs out while embroidering. • To restart embroidering from the beginning. • To continue embroidering after the machine was turned off. 	69
	 Starting position key	Specifies the needle position at the beginning of embroidering.	85
	 Trial embroidery key	Traces the outer edge of the embroidery design for placement.	61
	 Maximum embroidery speed key	Specify the maximum embroidery speed. <ul style="list-style-type: none"> • Specify a low speed for thin, thick or heavy fabrics. • When using a weak thread such as metallic thread, specify an embroidery speed of 400 spm. 	107

No.	Display Key Name	Function	Page
⑥	 Lock key	Unlocks the machine so it can start embroidering within 10 seconds. When this key is touched, the "Start/Stop" button flashes in green.	67
	 Return key	Return to the pattern editing screen.	—
	 Memory key	Save a pattern in the machine's memory, USB media or a computer.	87
	 Preview key	Display an image of the pattern that is to be embroidered so it can be previewed.	47
⑦	 Positioning keys	<ul style="list-style-type: none"> •   : Move the pattern in the direction shown by the arrow. • : Move to the center of the embroidering area. 	34
	 Frame movement speed keys	Select the speed to move the frame. <ul style="list-style-type: none"> : Touch to move the frame by 0.1 mm (approx. 1/64 inch). : Touch to move the frame by 0.5 mm (approx. 1/32 inch). : Keep touching to move the frame at maximum speed. 	—

Using the automatic thread cutting function [End Color Trim]

The automatic thread cutting function  will cut the thread at the end of embroidering each color. This function is initially turned on.

- This setting returns to its default  when the machine is turned off.

1 Touch .

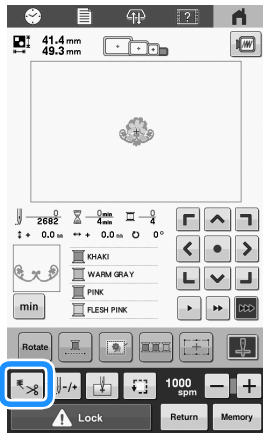

2 Touch  to turn off the automatic thread cutting function.

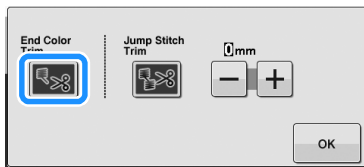

→ The key will display as .

→ When one color thread is embroidered, the machine will stop without cutting the thread.

3 Touch  to return to the original screen.

Using the thread trimming function [Jump Stitch Trim]

The thread trimming function  will automatically trim any excess thread jumps within the color. This function is initially turned on.

- Your customized setting remains after turning the machine off and on.

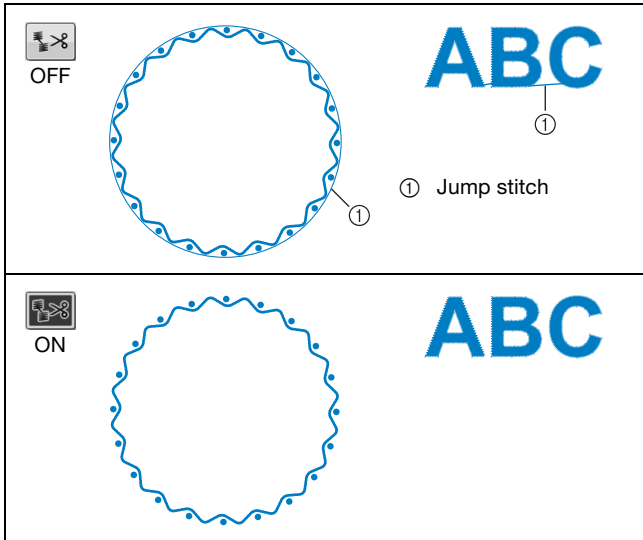

1 Touch .

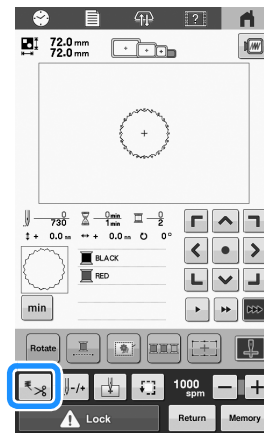

2 Touch  to turn off the thread trimming function.

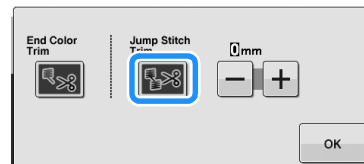

→ The key will display as .



→ The machine will not trim the thread before moving to the next stitching.

3 Touch  to return to the original screen.

■ Selecting the length of jump stitch not to trim

When the thread trimming function  is turned on, you can select the length of the jump stitch not to trim the thread.

→ Your customized setting remains after turning the machine off and on.

Touch  or  to select the length of jump stitch. For example: Touch  to select 25 mm (approx. 1 inch) and the machine will not trim a jump stitch of 25 mm or less before moving to the next stitching.

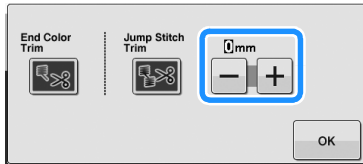

Memo





- If pattern has many trims, it is recommended to select a higher jump stitch trim setting in order to reduce the amount of excess tails on the wrong side of fabric.
- The higher the jump stitch length selected, the fewer number of times the machine will trim. In this case, more jump stitches remain on the right side of the fabric.

■ When using Tajima embroidery data (.dst)

When using Tajima embroidery data (.dst), you can select whether or not the thread is trimmed according to a specified number of jump codes.

Memo

- The “DST” setting will be applied with the next pattern that is loaded.

- 1 Check that the thread trimming function  is turned on. (page 58)
- 2 Touch  , and then display page 1 of the settings screen.
- 3 Touch  and  to select the number of jump codes.

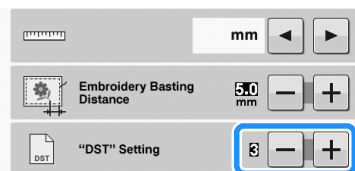

- For example, if [3] is specified, sequential 3 jump codes will be converted to the trim code. But sequential 2 jump codes will not be converted to the trim code, it will be embroidered as the feed (jump) stitch.

Note

- You need to set the jump number same as the number that was used when the particular Tajima data was created. If the jump number is not matched, either unexpected trim or no trimming at trim expected point will happen.

Thread color sorting



(page 22):

An instruction video is available for this topic.

You can embroider more efficiently by sorting combined designs' thread colors.

Before starting to embroider, touch  in the embroidering settings screen to rearrange the embroidering order and sort it by thread colors.

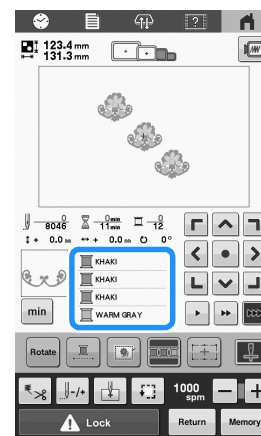
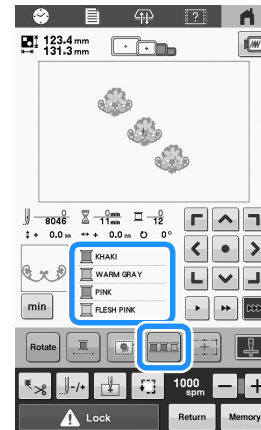

The embroidery color order is rearranged and sorted by thread colors.

Touch  to cancel the color sorting and embroider with the embroidery color order.

Note

- This function does not work on overlapping designs.

CHECKING THE POSITION OF THE PATTERN

The pattern is usually placed at the center of the embroidery frame. If you want to change where in the fabric the pattern will be embroidered, you can check the position before starting embroidering.

Checking the needle drop point with the Embroidery Crosshair Positioning Laser

- 1 Make sure that the Embroidery Crosshair Positioning Laser on/off key appears as  (ON).

→ The Embroidery Crosshair Positioning Laser indicates the needle drop point.

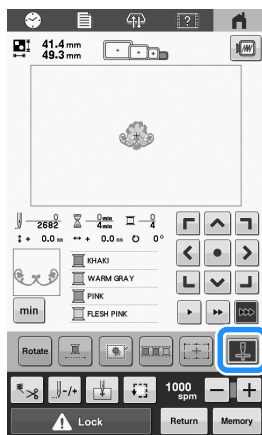

- Each touch of the key turns the setting either on or off.





Embroidery Crosshair Positioning Laser lights ON.

Embroidery Crosshair Positioning Laser lights OFF.

Memo

- With certain types of embroidery frames, the Embroidery Crosshair Positioning Laser function cannot be used.
- If the surface of the fabric is too uneven or rough, check and adjust the alignment of the Embroidery Crosshair Positioning Laser and the needle drop point before starting to embroider.
- When using the cap frame, check and adjust the alignment of the Embroidery Crosshair Positioning Laser and the needle drop point before starting to embroider.
- You can align the embroidering position with the Embroidery Crosshair Positioning Laser function. (page 77)

■ Adjusting the brightness of the Embroidery Crosshair Positioning Laser

- 1 Touch , and then touch  or  to display page 4 of the settings screen.

- 2 Touch .

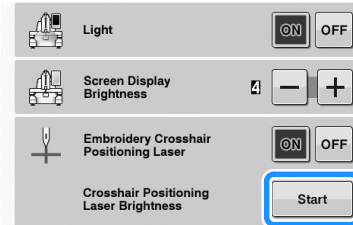

→ The Embroidery Crosshair Positioning Laser lights up, and the brightness adjustment screen for the Embroidery Crosshair Positioning Laser appears.



- 3 Touch  or  to adjust the brightness of the Embroidery Crosshair Positioning Laser.

- 4 Touch  twice to return to the previous screen.

Checking the embroidery pattern



(page 22):
An instruction video is available for this topic.

The carriage moves and shows the pattern position. Watch the embroidery frame closely to make sure the pattern will be embroidered in the right place. At this time, using the Embroidery Crosshair Positioning Laser function, the pattern position is projected on the fabric and you can check it more clearly.

- 1 Make sure that the Embroidery Crosshair Positioning Laser on/off key appears as .

→ The Embroidery Crosshair Positioning Laser indicates the needle drop point.



- 2 Touch .

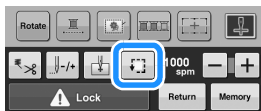

→ The embroidery frame moves to show the embroidery area.

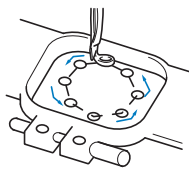

Carefully watch the movement of the embroidery frame and check that the embroidery will stitch in the desired location and that the embroidery frame does not hit the presser foot.

UPPER THREADING

In addition to checking the thread colors, information such as stitch count, stitching time and various other editing options can be performed in the embroidering screen. (page 56)

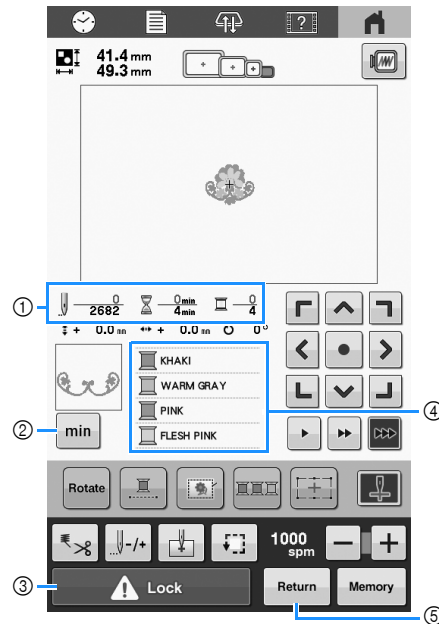

- 1 Shows the number of stitches, the embroidering time, and the number of thread color changes.
- 2 Display the embroidering time of each thread colors. To return to the thread color display, touch this key again.
- 3 When starting the machine or cutting the threads, touch this key to unlock the machine, and then press the "Start/Stop" button or thread trimming button.
- 4 Shows the embroidering order for the thread colors, or embroidering time of each thread color.
- 5 Return to the pattern editing screen.

⚠ CAUTION

- When  (unlock key) in the embroidering screen is touched, the "Start/Stop" button begins flashing in green and the machine can start embroidering. If the upper threading is being performed or the needle is being threaded, be careful that the machine is not accidentally started, otherwise injuries may result.

Upper threading

CAUTION

- When threading the upper thread, carefully follow the procedures. If the upper threading is not correct, the thread may become tangled or the needle may break and cause injury.



(page 22):
An instruction video is available for this topic.

Use embroidery thread to thread the needle.

Note

- It is recommended that rayon or polyester machine embroidery thread be used (120 den/2, 135 dtex/2, 40 weight (in Americas and Europe), #50 (in Japan)).
- Certain types of thread may break or have improper tension. In such a case, change the thread.
- The path that the machine should be threaded is indicated by a line on the machine. Be sure to thread the machine as indicated.

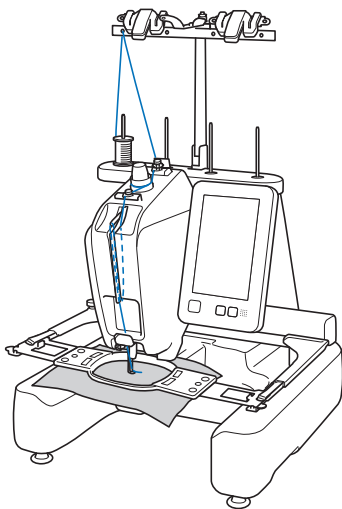

- 1 Place the first thread spool on any spool pin among the four positions. Push the spool cap onto the spool pin as far as possible to secure the thread spool.

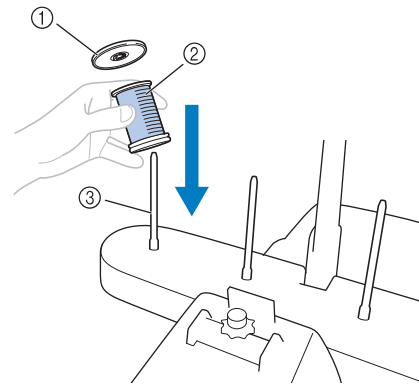

- ① Spool cap
- ② Thread spool
- ③ Spool pin

- When using thread that winds off quickly, such as metallic thread, place the included spool net over the spool. If the spool net is too long, fold it once to match the size of the spool before placing it over the spool. It may be necessary to adjust thread tension when using the spool net.

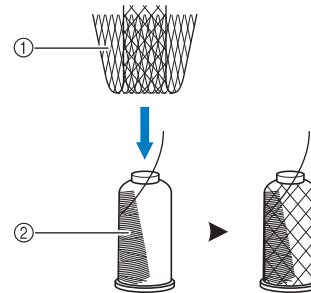

- ① Spool net
- ② Thread

- When using small spools of thread, be sure to place the included spool mat on the spool pin before placing the spool on the pin.

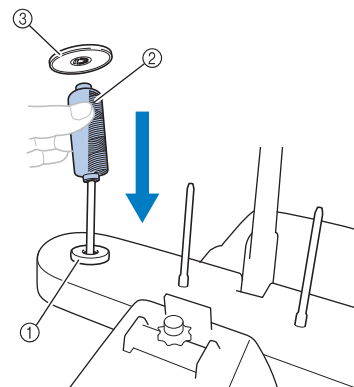

- ① Spool mat
- ② Small spool
- ③ Spool cap

2 Pass the thread from the back to the front through the thread guide hole just above the spool.

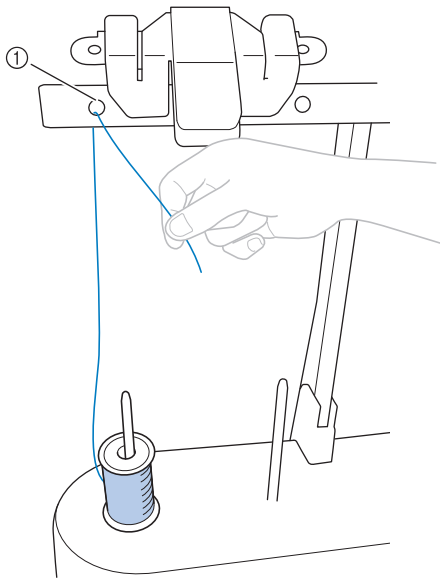

① Thread guide hole above the spool

3 Pull the thread toward you through the inside of the front hole in the thread guide.

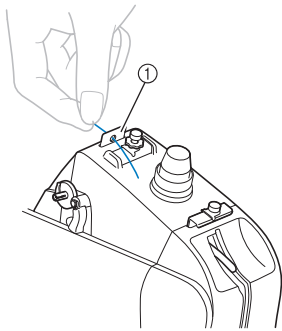

① Front hole in the thread guide

4 Hold the thread with both hands, and then pass it under the guide plate of the upper thread guide from the left to the right.

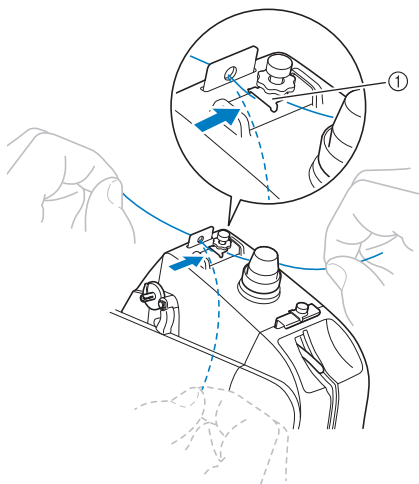

① Guide plate

5 Wind the thread clockwise once around the thread tension disc.

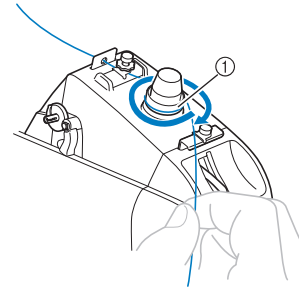

① Thread tension disc

- Make sure that the thread is securely caught in the thread tension disc.

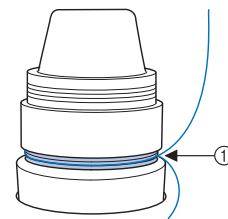

① Pass around here.

6 Pass the thread under the guide plate of the middle thread guide from the left.

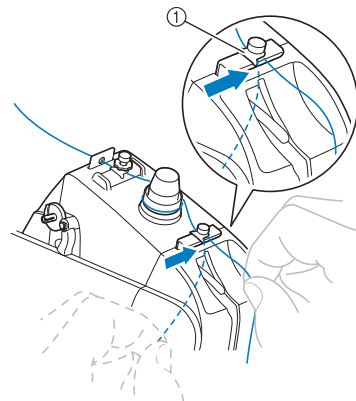

① Guide plate

- 7** Pass the thread along the slot to pass it through the thread take-up lever hole from the right side.

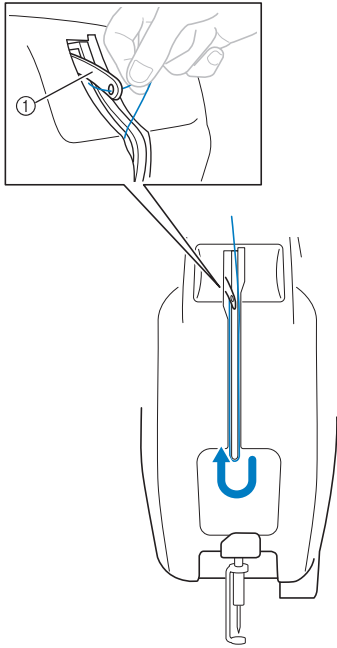

① Thread take-up lever

- 8** Draw the thread down through the slot, and then through the hole in lower thread guide.

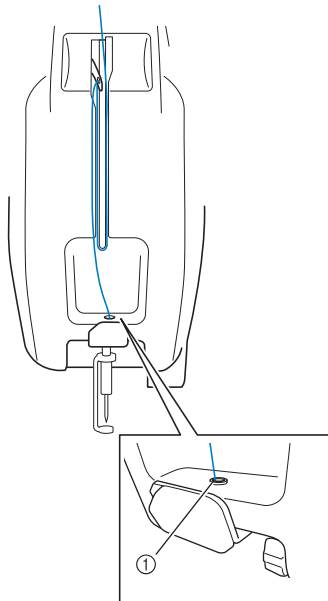

① Hole in lower thread guide

- 9** Use the included needle changing tool (threader) ① to pass the thread into the needle bar thread guide ②.

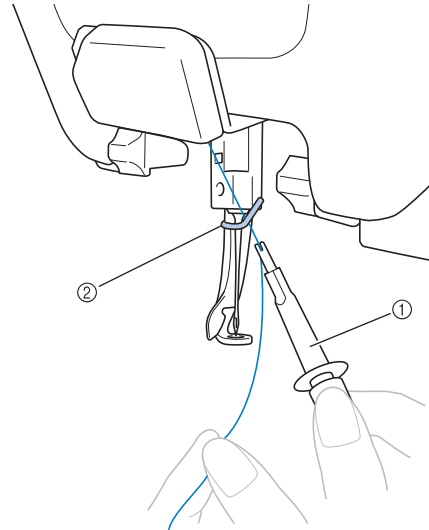

- ① Needle changing tool (Threader)
② Needle bar thread guide

Memo

- Up to four thread spools can be prepared on a spool stand for the next color change. By hooking the thread on the thread cutter/holder, the thread can be smoothly replaced with that of the next color.

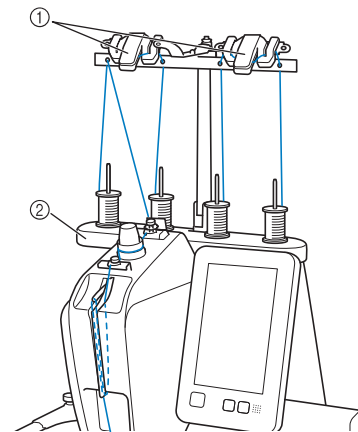

- ① Thread cutter/holders
② Spool stand

Threading the needle

Use the automatic needle-threading mechanism to thread the needle.

IMPORTANT

- When using 65/9 needles or thinner, manually thread the needle. If the automatic needle-threading mechanism is used, its hook may be damaged.
- If the needle is not fully inserted, the hook of the automatic needle-threading mechanism will not pass through the eye of the needle during automatic needle threading, and the hook may bend or the needle cannot be threaded.
- If the hook of the automatic needle-threading mechanism is damaged, you cannot thread the machine. In this case, replace the hook by yourself. (page 97)
- While the hook of the automatic needle-threading mechanism is passed through the eye of the needle, do not rotate the handwheel. The automatic needle-threading mechanism may be damaged. If you turn the handwheel, the automatic needle-threading mechanism will return to its initial position to avoid damage.

- 1 Press the automatic needle-threading button.

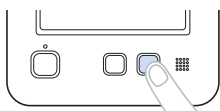

→ The hook of the automatic needle-threading mechanism passes through the eye of the needle.

- 2 Pull out about 15 cm (approx. 6 inches) of thread. Then, as shown in the illustration, pass the thread under the fork of the automatic needle-threading mechanism from the right, and then catch the thread with the hook that passes through the eye of the needle.

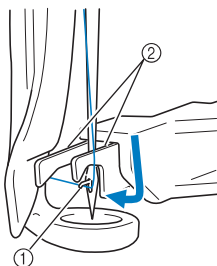

- ① Hook
- ② Fork

Note

- When catching the thread with the hook, be careful that the thread does not become loose.

- 3 Pass the thread under the guide on the presser foot.

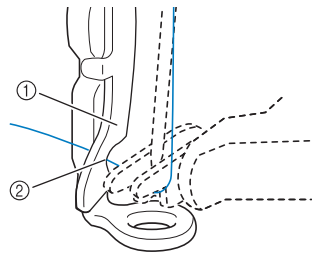

- ① Guide on presser foot
- ② Notch in guide on presser foot

- Make sure that the thread securely passes through the notch in the guide on the presser foot.

- 4 Securely pass the thread through the groove in the thread cutter, and then lightly pull the thread to cut it.

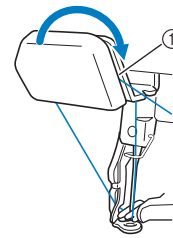

- ① Groove in thread cutter

Note

- If the thread is not correctly passed through the groove in the thread cutter, the message [Wiper error] appears and the needle cannot be threaded. Be sure to securely pass the thread through the groove.
- Pull out enough thread. If enough thread is not pulled out, the thread cannot be pulled through the thread cutter.

Memo

- The Wiper is the mechanism for pulling the thread to back when the needle threader is used and when the thread is trimmed during embroidery.

- 5 Press the automatic needle-threading button.

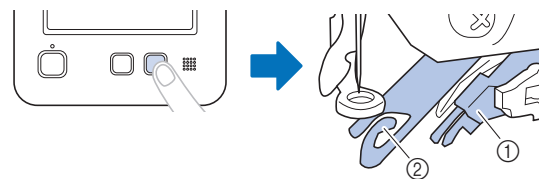

- ① Automatic needle-threading mechanism
- ② Wiper

- The threader moves back away from the needle. The thread is pulled through the needle eye.
- The wiper comes out and catches the thread between the needle and the threader.
- The threader goes back to the original home position.

This completes the threading.

Note

- If the thread is not taut, it may come out of the thread tension disc. After upper threading is finished, check again to make sure that the thread is correctly passed into the thread tension disc. (step 5 on page 63)

Easily changing the thread spools

When replacing the thread spools, it is necessary to re-thread the upper thread. However, the thread spools can easily be changed when replacing a thread spool whose thread is correctly threaded through the machine.

- 1 Cut the thread between the thread spool and the thread guide.

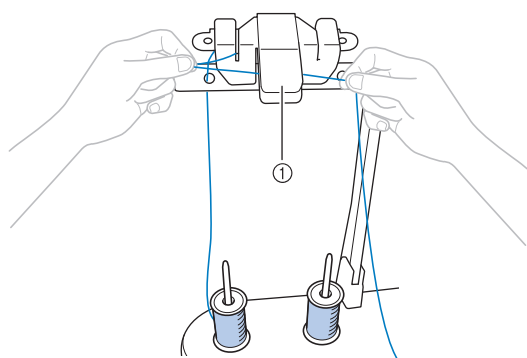

① Thread cutter

- 2 Change the thread spool.

- 3 Tie the end of the thread on the new spool with the end of the thread remaining from the previous color.

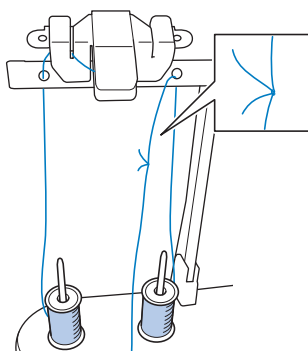

- 4 Pull out the old thread just after the needle bar thread guide.

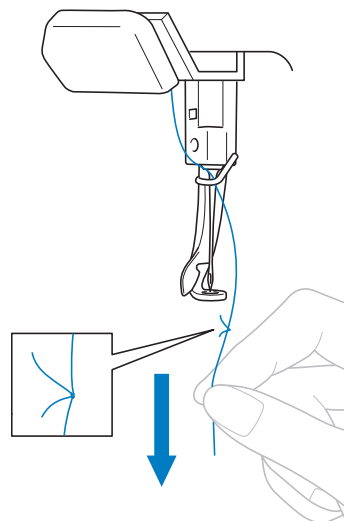

Continue pulling the thread until the knot is below the needle. Cut the knot.

- 5 Use the automatic needle-threading mechanism to thread the needle with the new thread. (page 65)

→ This completes the changing of the thread spool.

IMPORTANT

- When pulling out the thread, do not pull the knot through the eye of the needle. If the knot is pulled through the eye of the needle, the needle may be damaged.

PERFORMING THE EMBROIDERY

Now, the machine is ready to begin embroidering. When the machine starts embroidering, the presser foot is automatically lowered, the necessary thread trimming operations at the beginning of stitching and at the end of stitching are performed, the threads are changed as necessary while the embroidery is performed, and the machine stops when the end of the stitching is reached.

⚠ CAUTION

- While the machine is in operation, pay special attention to the needle location. In addition, keep your hands away from all moving parts such as the needle, thread take-up lever and carriage, otherwise injuries may result.

IMPORTANT

- When embroidering overlapping stitches, it is difficult for the needle to penetrate the fabric, possibly resulting in the needle bending or breaking.

Starting embroidering

Note

- Make sure that there are no objects within the moving area of the embroidery frame. If the embroidery frame hits another object, the pattern may become misaligned.
- When embroidering large pieces of fabric, make sure that the fabric is not caught in the carriage.

- 1 Touch  to unlock the machine.

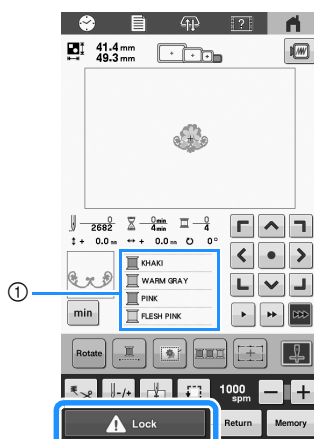

- 1 The thread color being used for embroidering or will soon be used for embroidering appears at the top of the thread color sequence display. The remaining thread colors are listed in the embroidering order, starting from the top.

→ The “Start/Stop” button changes from lit in red (locked machine) to flashing in green (unlocked

machine), and the machine is ready to begin embroidering.

- If the “Start/Stop” button is not pressed within 10 seconds after unlocking the machine, the machine becomes locked again.

- 2 Press the “Start/Stop” button.

Press the “Start/Stop” button while it is flashing in green. If the “Start/Stop” button returns to being lit in red, perform this procedure again from step 1.

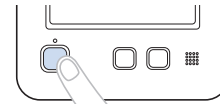

→ The “Start/Stop” button lights up in green and begins embroidering the first color.

- While the machine is embroidering, the point being embroidered is indicated by the green cross hairs in the pattern display area. In addition, the number of stitches and the time count up.

- 3 After embroidery of the first color is finished, the machine automatically stops and trims the thread.

- 4 Unthread the first color from the machine.

- 5 Thread the machine with the second color and then repeat the same steps for embroidering the second color. This continues until the last color is embroidered, and the machine automatically stops.

→ The “Start/Stop” button lights up in red.

- No thread trimming operations at the beginning of stitching and at the end of stitching are necessary.

Continuing embroidering

To select a new pattern, touch .

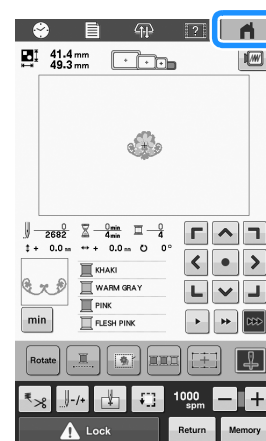

→ The pattern type selection screen appears.

Stopping embroidering

The machine can be stopped during embroidering.

■ Temporarily pausing

- 1 Press the “Start/Stop” button.

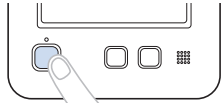

→ The machine stops and the “Start/Stop” button lights up in red.

- Embroidering can also be stopped by touching an area displaying the pattern.
- The thread is not trimmed.
- To continue embroidering, after checking that the upper thread is taut, touch  Lock, and then press the “Start/Stop” button.

■ Temporarily pausing for extended periods of time

- 1 Press the “Start/Stop” button.

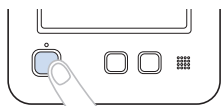

→ The machine stops and the “Start/Stop” button lights up in red.

- The thread is not trimmed.

- 2 Touch  Lock to unlock the machine.

- 3 Press the thread trimming button.

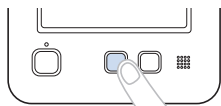

→ The bobbin and upper threads are trimmed.

- Before turning off the machine, be sure to trim the threads.

- 4 Set the main power switch to “O” to turn off the machine.

→ The display and the “Start/Stop” button indicator go off.

- Embroidery can resume after the machine is turned on again. Back up several stitches to overlap the stitching. (page 71)

■ If the thread breaks while embroidering

If a problem occurs while embroidering, such as if the thread breaks, the machine stops automatically. Re-thread the broken thread, back up several stitches, and then continue embroidering. (page 69)

REMOVING THE EMBROIDERY FRAME

⚠ CAUTION

- When removing the embroidery frame, make sure that the “Start/Stop” button is lit in red. If the “Start/Stop” button is flashing in green, the machine may start embroidering. If the machine accidentally starts operating, injuries may result.

IMPORTANT

- When removing the embroidery frame, be careful that the embroidery frame does not hit any other part of the machine.
- Do not lift up the Embroidery Frame Holder with extreme force, otherwise it may be damaged.

- 1 With both hands, grab the left and right sides of the arms of the Embroidery Frame Holder, and then slightly lift up the frame.

The pins on the arms of the Embroidery Frame Holder should come out of the holes in the sides of embroidery frame.

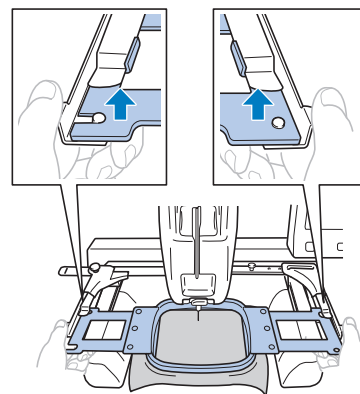

- 2 Pull off the embroidery frame toward you.

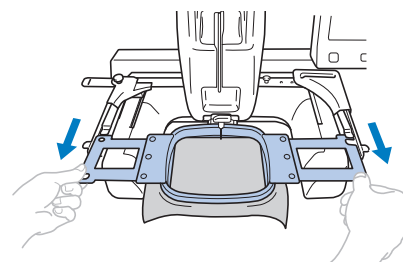

→ Remove the fabric from the frame.

ADJUSTING WHILE EMBROIDERING

If the thread breaks or the bobbin thread runs out while embroidering



(page 22):
An instruction video is available for this topic.

If the thread breaks or the bobbin thread runs out while embroidering, the machine will automatically stop. Since some stitches may be embroidered with only one thread, go back through the stitching to a point prior to the stoppage before continuing to embroider.

Note

- If [Upper and Bobbin Thread Sensor] is set to [OFF], the machine does not stop until embroidering is finished. Normally, the [Upper and Bobbin Thread Sensor] should be set to [ON].
- Be careful when going back or forward through the stitching since the embroidery frame moves at the same time.

■ If the upper thread breaks

1 Re-thread the upper thread. (page 62)

2 Touch .

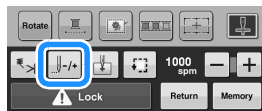

→ The stitch navigating screen appears.

3 Touch and to go back through the stitching to a point where stitches have already been embroidered.

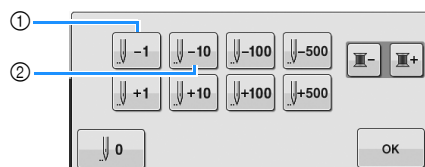

- ① Each touch of this key moves one stitch back through the stitching.
- ② Each touch of this key moves ten stitches back through the stitching.

Note

- It is recommended to stitch over the top of the last two or three stitches for complete coverage.

If the needle bar is moved back too far through the stitching, touch or to go forward through the stitching.

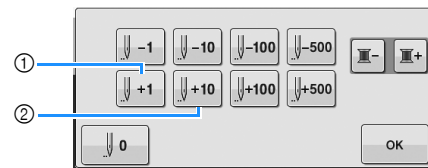

- ① Each touch of this key moves one stitch forward through the stitching.
- ② Each touch of this key moves ten stitches forward through the stitching.

4 Touch .

→ The embroidering screen appears again.

5 Touch and then press the "Start/Stop" button to continue embroidering.

■ If the bobbin thread breaks or runs out

1 Touch and then press the thread trimming button.

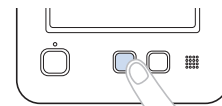

→ The upper thread is trimmed.

2 Remove the stitches embroidered only with the upper thread.

Pull the trimmed end of the upper thread.

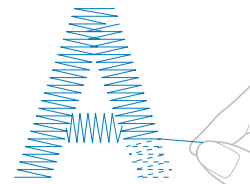

- If the stitches cannot be cleanly removed, trim the thread with scissors.

■ If the bobbin thread ran out, replace the bobbin at this point in the procedure.

- 3 Replace the bobbin with a bobbin wound with bobbin thread. (page 23)

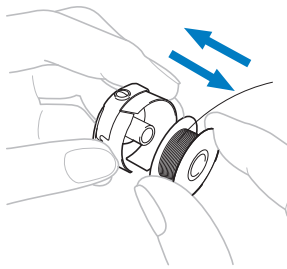

- If the hook cover can be opened, replace the bobbin without removing the embroidery frame from the machine.
- If the machine bed is hidden, for example, with a bag-shaped piece of fabric, or if the hook cover cannot be opened, temporarily remove the embroidery frame. (page 68) After replacing the bobbin, re-attach the embroidery frame. (page 52)

Note

If the embroidery frame is removed before embroidering of the pattern is finished, take caution, otherwise the pattern may become misaligned.

- Do not apply extreme pressure to the framed fabric and cause it to become loose.
- When removing and re-attaching the embroidery frame, do not allow the frame to hit the carriage or the presser feet.
If the carriage is hit and moves, turn the machine off, then on again. The correct frame position at the time that the machine was stopped is stored in the machine's memory, and the embroidery frame is returned to the correct position.
- When the embroidery frame is re-attached, make sure that the pins on the left and right arms of the Embroidery Frame Holder securely fit into the holes in the handles on the embroidery frame.

- 4 Go back through the stitching in the same way as that described in step 2 through 5 of "If the upper thread breaks" on page 69, and then continue embroidering.

Embroidering from the beginning or middle of the pattern

If you wish to restart embroidering from the beginning, for example, if trial embroidery was performed and an incorrect thread tension was used or if the wrong thread color was used, restart the embroidering using the forward/backward stitch key. In addition, you can go forward or back through the stitching by thread color or by stitch to start stitching at any position of the pattern.

Note

- Be careful when going back or forward through the stitching since the embroidery frame moves at the same time.

- 1 Press the "Start/Stop" button to stop the machine.







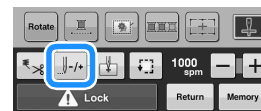





- If necessary, trim and remove the embroidered stitches.

- 2 Touch .



→ The stitch navigating screen appears.

- 3 Touch  and  to select a color in the thread color sequence, and then touch , , , , , ,  and  to select the stitch.

- Touch  to embroider from the beginning.

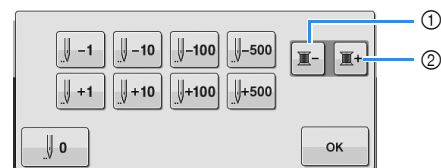

- ① Touch this key once to return to the beginning of the stitching for the color being embroidered. Afterward, each touch of this key returns to the beginning of the previous thread color.

- ② Each touch of this key advances to the beginning of embroidering the next thread color.

→ The needle bar moves to the embroidering position, and then the embroidery frame moves and current needle position is indicated.

- 4 After selecting the stitch from where embroidering is to begin, touch .

→ The embroidering screen appears again.

- 5 Touch , and then press the "Start/Stop" button to start embroidering.

→ Embroidering starts from the specified point.

Resume embroidering after turning off the machine

In either of the following cases, the remaining stitches of the embroidery are stored in the machine's memory.

- If the machine's power switch is pressed to turn off before stopping embroidering:
Cut the thread before the machine's main power switch is turned off, otherwise the thread may be pulled or may catch when the carriage returns to its initial position after the machine is turned on again.
- If the machine was accidentally turned off, for example, due to a power outage, while it was embroidering:
The remainder of the embroidery can be performed when the machine is turned on again; however, some of the stitches that were already embroidered may be embroidered again.

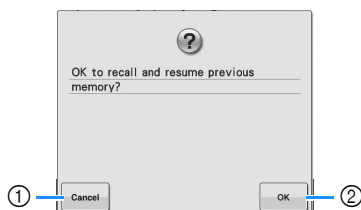

- ① Cancel embroidering and display the pattern type selection screen to select a new pattern.
- ② Continue embroidering.

→ The embroidering screen displayed before the machine was turned off appears.

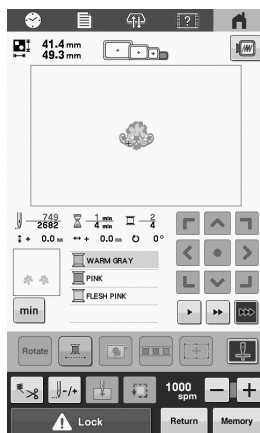

Note

- You may need to advance or reverse through the stitches to get to the correct needle drop position.

Chapter 3 ADVANCED EMBROIDERY

3

VARIOUS EMBROIDERY FUNCTIONS



Basting embroidery

Before embroidering, basting stitches can be embroidered along the outline of the pattern. This is useful for embroidering fabric that cannot have stabilizer material affixed with an iron or adhesive. By stitching stabilizer material to the fabric, shrinkage of the stitching or misaligned patterns can be minimized.

Note

- It is recommended to finish combining and editing the pattern before selecting the basting setting. If the pattern is edited after selecting the basting setting, the basting and pattern may become misaligned, and the basting under the pattern may be difficult to remove after embroidering is complete.

1 Touch , and then display page 1 of the settings screen.

2 Use  and  to specify the distance from the pattern to the basting stitching.

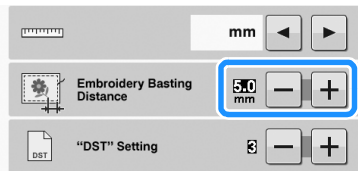

Memo



- The higher the setting, the farther the basting is from the pattern.
- The setting remains selected even if the machine is turned off.

3 Touch  to return to the embroidering screen.

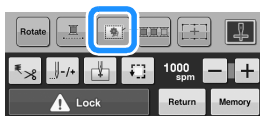
4 Touch  to select the basting setting.



Note

- When  is touched, the pattern is moved to the center. After selecting the basting setting, move the pattern to the desired position.
- To cancel the setting, touch .

→ Basting is added to the beginning of the embroidering order.

5 Touch , and then press the "Start/Stop" button to start embroidering.

6 When embroidering is finished, remove the basting stitching.

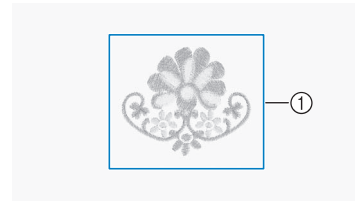

① Basting stitching

Embroidering appliqué patterns

Some of the built-in embroidery patterns can be used for embroidering appliqués. Follow the procedures described below to embroider appliqués using the patterns with [APPLIQUE MATERIAL], [APPLIQUE POSITION] or [APPLIQUE] in the region display at the top of the thread color sequence display.

* Depending on the thread color display setting, the display may appear below.

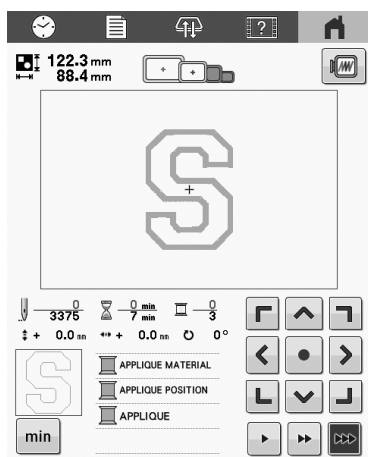
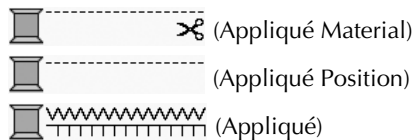

■ Procedure for embroidering appliqués

- 1 Place stabilizer on the back of the appliqué fabric/material.
- 2 Frame the fabric for the appliqué (from step 1) in the embroidery frame, and then embroider an [APPLIQUE MATERIAL] pattern. The stitching outline that indicates where the appliqué will be cut out is embroidered, and then the machine stops.

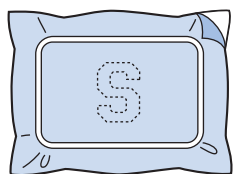

- 3 Remove the appliqué fabric from the embroidery frame, and carefully cut along the pattern stitching outline.

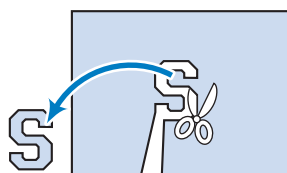

Note

- If the appliqué is cut out along the inside of the embroidered cut line, the appliqué may not be correctly attached to the fabric. Therefore, carefully cut out the appliqué along the embroidered cut line. If this step is not performed carefully, the appliqué will not be cleanly finished. In addition, carefully remove any excess threads.

- 4 Attach stabilizer material to the wrong side of the fabric for the appliqué base.
- 5 Frame the base fabric or garment in the embroidery frame, and then embroider an [APPLIQUE POSITION] pattern. Once the appliqué position is embroidered, the machine stops.

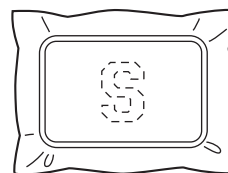

- 6 Lightly apply fabric glue or spray adhesive to the back of the cut out appliqué piece, and then position the appliqué piece to the base fabric on the embroidered pattern from the Appliqué position pattern step 5.

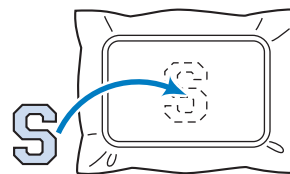

Note

- Do not remove the fabric from the embroidery frame when positioning the appliqué piece to the base fabric.

- 7 After positioning the appliqué piece, embroider the [APPLIQUE] pattern. The appliqué is finished.

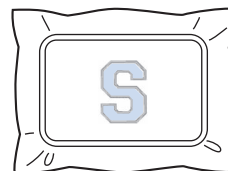

Memo

- Depending on the pattern, an [APPLIQUE] pattern may not be available. In this case, embroider the appliqué using thread in the color of a part of the embroidery.

Using a frame pattern to create appliqués

With this method, there is no need to change the fabric in the embroidery frame. The appliqué can be created by embroidering two frame patterns of the same size and shape—one embroidered with straight stitches and the other embroidered with satin stitches.

- 1 Select a frame pattern embroidered with straight stitches and embroider onto the base fabric.

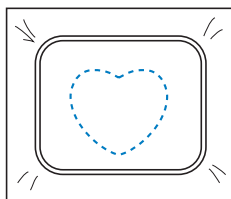
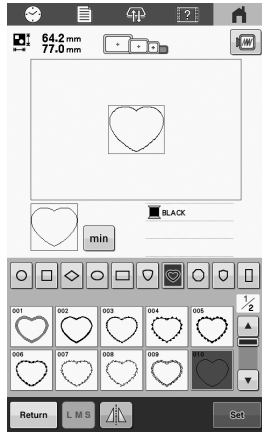

- 2 Place the appliqué fabric over the embroidery stitched in step 1. Make sure that the appliqué fabric is larger than the embroidered area.

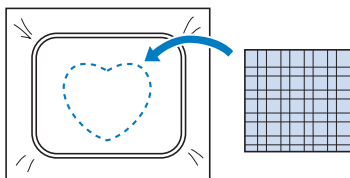

- 3 Embroider over the appliqué fabric using the same frame pattern.

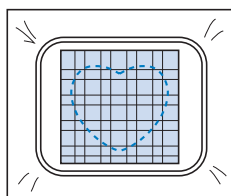

- 4 Remove the embroidery frame from the machine, and then trim the excess appliqué fabric along the outside of the stitching.

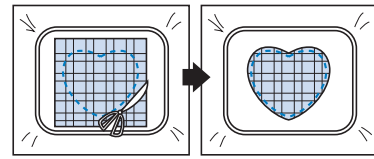

Note

- Leave the fabric in the embroidery frame when cutting off the excess appliqué fabric. In addition, do not apply extreme pressure to the framed fabric, otherwise the fabric could become loose.

- 5 Select the satin-stitched frame pattern with the same shape.

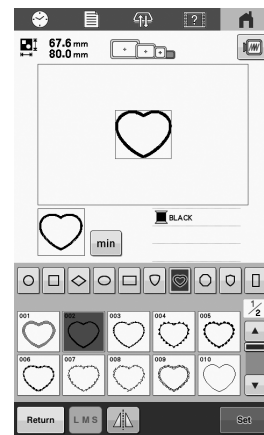

Note

- If the size or embroidering pattern of the straight-stitched frame pattern is changed, be sure to change the size or embroidering pattern of the satin-stitched frame pattern in the same way.

- 6 Attach the embroidery frame removed in step 4, and then finish embroidering the appliqué.

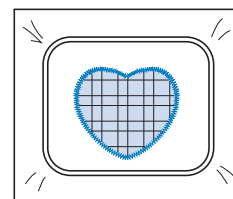

Making 3D font embroidery with urethane foam



(page 22):

An instruction video is available for this topic.

You can make 3D font embroidery by using urethane foam for embroidery.

Note

- Use urethane foam with a thickness no more than 3 mm (approx. 1/8 inch).

1 Touch **AA**.

2 Touch the 3D font.

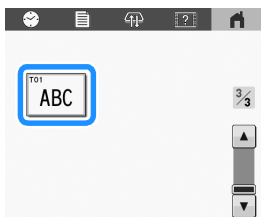

3 Select the character category and then select the characters. (page 32)

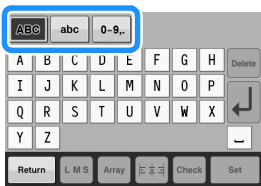

4 Touch **Set**.

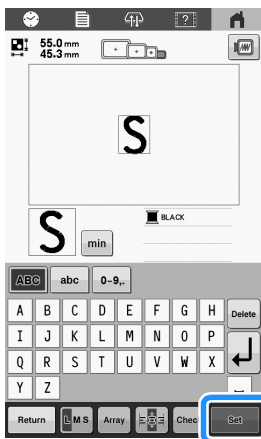

→ The pattern editing screen appears.

5 Follow the procedure from step 4 to 7 of “Embroidery patterns” on page 29.

Note

- Basting around the pattern will secure the urethane foam more firmly during embroidering. After completing step 5, touch  in the embroidering screen. After adding basting, continue with step 6 to finish embroidering.

6 Cut the urethane foam so that it will be larger than the 3D font pattern.

- Refer to the pattern size in the screen to determine the required size of urethane foam, and then cut the foam with a little excess.

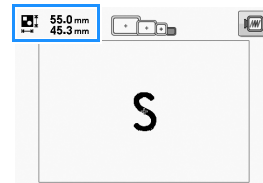

7 Use tape to secure the urethane foam.

- Do not apply tape where it will overlap a pattern.
- Firmly secure the urethane foam with tape so that it does not shift during embroidering.

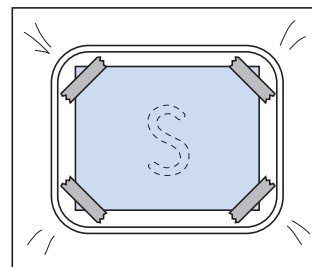

8 Touch  to check the position of the pattern and make sure it does not extend out of the urethane foam. (page 61)

Note

- Do not apply tape where it will overlap a pattern.

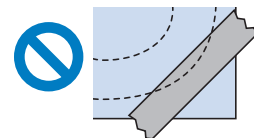

9 Touch  **Lock**, and then press the “Start/Stop” button to start embroidering.

Note

- Adjust the thread tension so that the bobbin thread is tighter (page 81) and the upper thread is looser (page 82). If the upper thread is too tight, the bobbin thread will be visible from the right side of the fabric, and the embroidery will not have a clean finish.

10 When embroidering is finished, remove the tape securing the urethane foam.

11 Remove excess urethane foam from around the pattern.

- Carefully remove the excess urethane foam since pulling on a thread will cause a thread loop to form on the right side of the fabric, spoiling the clean finish.

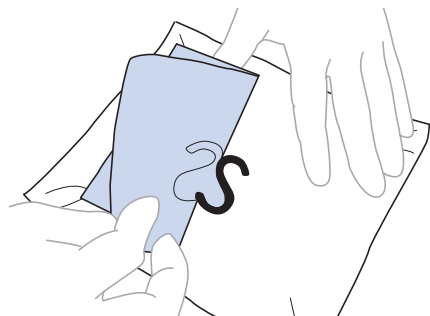

Note

- If the urethane foam sticks out between stitches, heat it with an iron to shrink it and to improve the finish. Apply steam with a steam iron in order to avoid crushing the embroidery. If your iron does not have a steam function, apply heat from a distance to avoid direct contact with the embroidery.
- If the iron temperature is too high, the thread or fabric may melt.

USING THE EMBROIDERY CROSSHAIR POSITIONING LASER FUNCTION TO ALIGN THE EMBROIDERING POSITION

By using the Embroidery Crosshair Positioning Laser function, the embroidering position can easily be aligned. This is useful when embroidering in an area where it is necessary to align the pattern, as shown below.

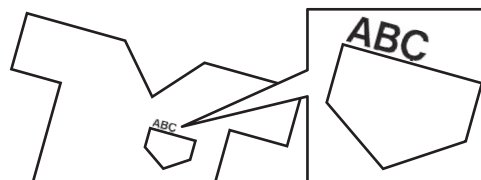

1 Use a chalk pencil to mark the desired embroidering position.

The line drawn for the reference direction should be longer.

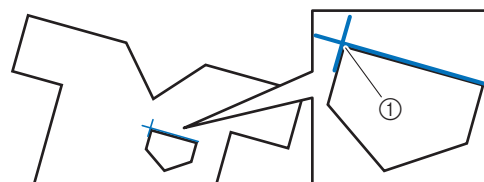

① Chalk pencil mark

Memo

- If the desired position of the pattern can be clearly established, such as when embroidering along a pocket, it is not necessary to mark the position with a chalk pencil.

2 Hoop the fabric in the embroidery frame.

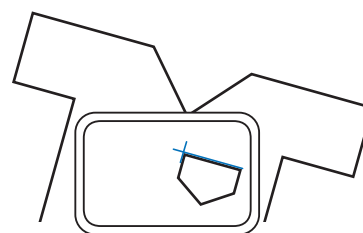

Note

- When hooping the fabric in the embroidery frame, make sure that the embroidery pattern will fit within the embroidering area of the frame being used.

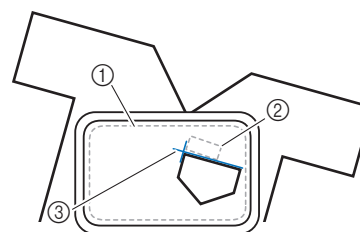

① Embroidering area
② Embroidery pattern size
③ Chalk pencil mark

3 Select the pattern.

4 Touch **Embroidery** to display the embroidering screen.

5 Touch  in the embroidering screen.

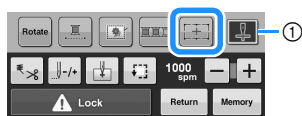

① Switch on/off the Embroidery Crosshair Positioning Laser.

Memo

- The Embroidery Crosshair Positioning Laser lights up to indicate the needle drop point.
- With certain types of embroidery frames, the Embroidery Crosshair Positioning Laser function cannot be used.
- If the surface of the fabric is too uneven or rough, check and adjust the alignment of the Embroidery Crosshair Positioning Laser and the needle drop point before starting to embroider.
- When using the cap frame, check and adjust the alignment of the Embroidery Crosshair Positioning Laser and the needle drop point before starting to embroider.

6 If a message appears, indicating that the move and rotate settings will return to the original ones, touch .

7 From the reference points shown in the screen, select the point to be used for aligning the pattern.

For this example, select the point in the lower-left corner of the pattern.

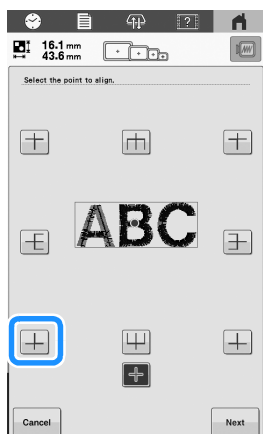

Memo

- Even if the Embroidery Crosshair Positioning Laser function is set to [OFF], the Embroidery Crosshair Positioning Laser appears so that the pattern can be aligned. When pattern alignment is completed, the Embroidery Crosshair Positioning Laser goes off.
- In order for the Embroidery Crosshair Positioning Laser to be easily seen, the brightness of the embroidery light will be slightly decreased if it was set at a high setting.

8 Touch .

9 Select the direction (from the reference point) to be used as a reference for aligning the pattern.

For this example, select the arrow pointing to the right as the reference direction.

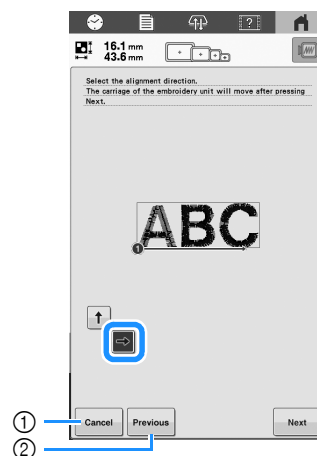

- ① Cancel the pattern alignment settings.
- ② Return to the previous screen.

10 Touch .

11 Touch the positioning keys to move the embroidery frame until the Embroidery Crosshair Positioning Laser and the center of the mark are aligned.

To change the speed that the frame moves, use the frame movement speed keys. If it is difficult to make a precision alignment, touch a frame movement speed key for a slower speed.

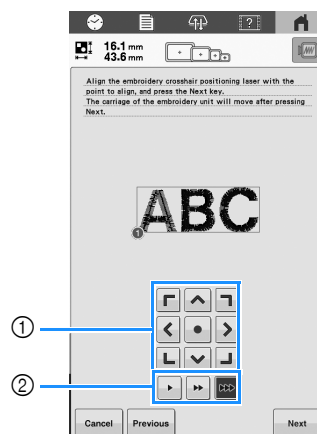

- ① Positioning keys
- ② Frame movement speed keys

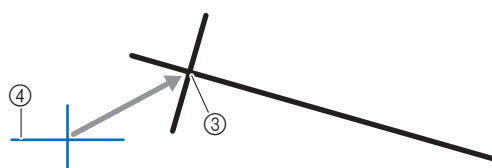

- ③ Center of mark
- ④ Embroidery Crosshair Positioning Laser

12 Touch **Next**.

13 Touch the positioning keys to move the embroidery frame until the Embroidery Crosshair Positioning Laser is aligned with the mark in the reference direction.

To change the speed that the frame moves, use the frame movement speed keys. If it is difficult to make a precision alignment, touch a frame movement speed key for a slower speed.

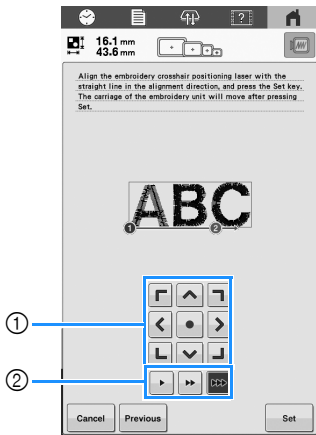

- ① Positioning keys
- ② Frame movement speed keys

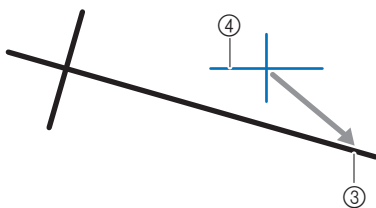

- ③ Reference direction of mark
- ④ Embroidery Crosshair Positioning Laser

Note

- Do not set the position of the Embroidery Crosshair Positioning Laser too close to the center of the mark. If it is too close, a message will appear, prompting you to reposition it.
- For best accuracy, set the position of the Embroidery Crosshair Positioning Laser on the reference direction of mark (③) as far away from the center of the mark as possible.

14 Touch **Set**.

→ The pattern is repositioned.

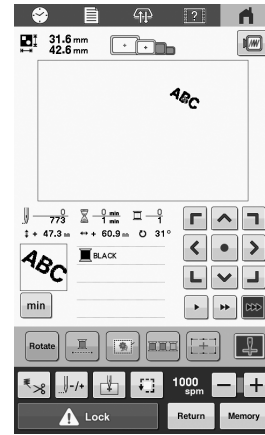

15 Touch **Lock**, and then press the "Start/Stop" button to start embroidering.

Another example

By specifying an alignment point and direction, embroidery patterns can be positioned and aligned for various purposes.

In this example, a pattern is aligned at the left center of the towel.

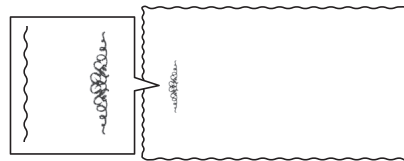

1 Use a chalk pencil to mark the desired embroidering position.

The line drawn for the reference direction should be longer.

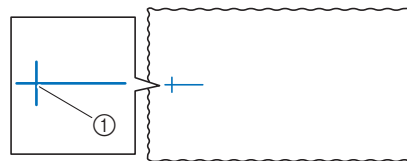

- ① Chalk pencil mark

2 Hoop the fabric in the embroidery frame.

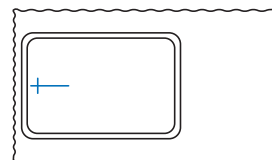

3 Select the pattern.

4 Touch **Embroidery** to display the embroidering screen.

5 Touch  in the embroidering screen.

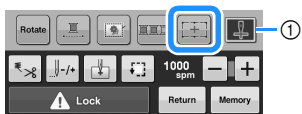

① Switch on/off the Embroidery Crosshair Positioning Laser.

6 If a message appears, indicating that the move and rotate settings will return to the original ones, touch .

7 From the reference points shown in the screen, select the point to be used for aligning the pattern.

For this example, select the point in the lower-center of the pattern.

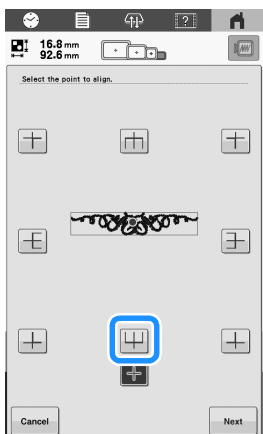



8 Touch .

9 Select the direction (from the reference point) to be used as a reference for aligning the pattern.

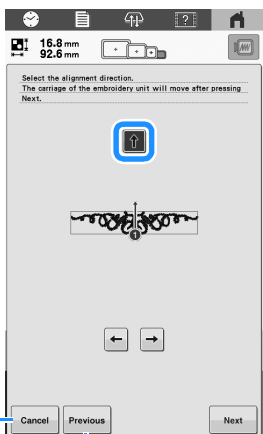
For this example, select the arrow pointing upward as the reference direction.



①  Cancel the pattern alignment settings.
②  Return to the previous screen.

10 Touch .

11 Touch the positioning keys to move the embroidery frame until the Embroidery Crosshair Positioning Laser and the center of the mark are aligned.

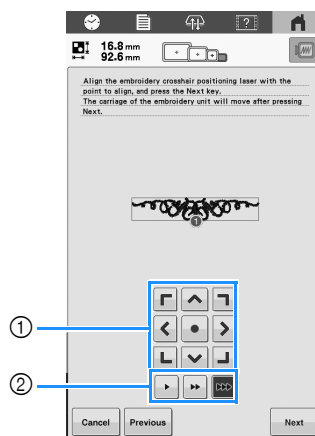

① Positioning keys
② Frame movement speed keys

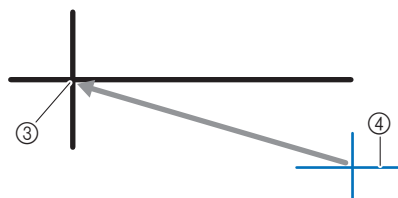

③ Center of mark
④ Embroidery Crosshair Positioning Laser

12 Touch **Next**.

13 Touch the positioning keys to move the embroidery frame until the Embroidery Crosshair Positioning Laser is aligned with the mark in the reference direction.

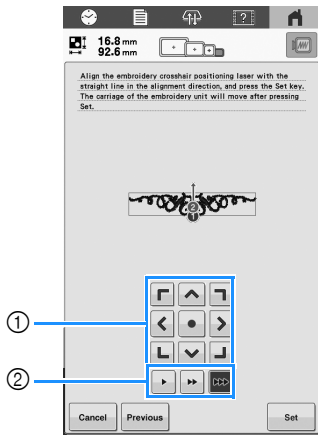

- ① Positioning keys
- ② Frame movement speed keys

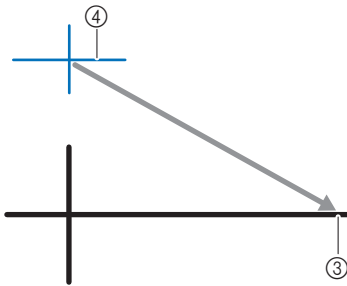

- ③ Reference direction of mark
- ④ Embroidery Crosshair Positioning Laser

14 Touch **Set**.

→ The pattern is repositioned.

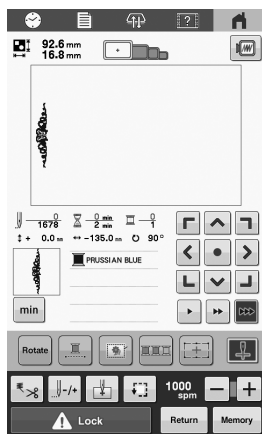

15 Touch **Lock**, and then press the “Start/Stop” button to start embroidering.

MAKING EMBROIDERY ADJUSTMENTS

Adjusting the tension of the bobbin thread

Note

- Be sure to check the tension of the bobbin thread each time that the bobbin is changed.
- Be sure to adjust the tension of the bobbin thread before adjusting the tension of the upper thread.

1 Tie the included weight to the end of the thread extending from the bobbin case.

Prewound bobbins:

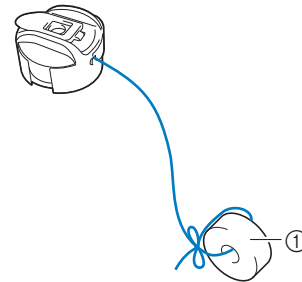

- ① Weight (L)

Note

- Different weights are used to adjust prewound bobbins and metal bobbins.

Metal bobbins:

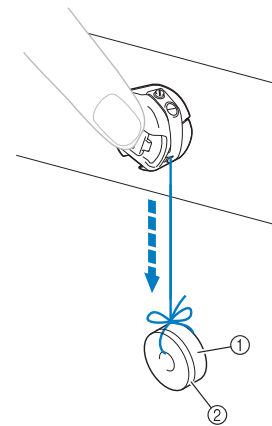

- ① Weight (L)
- ② Weight (S)

- 2 As shown in the illustration, hold the bobbin case against a smooth vertical surface.

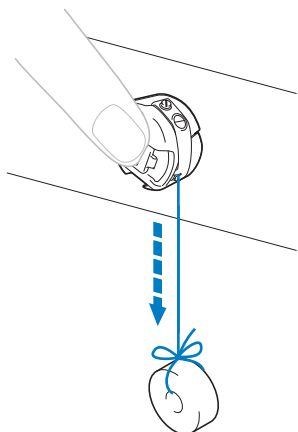

- If the thread with the weight attached is slowly pulled out, the thread tension is correct.

- 3 Use the included standard screwdriver to turn the tension-adjusting screw and adjust the thread tension.

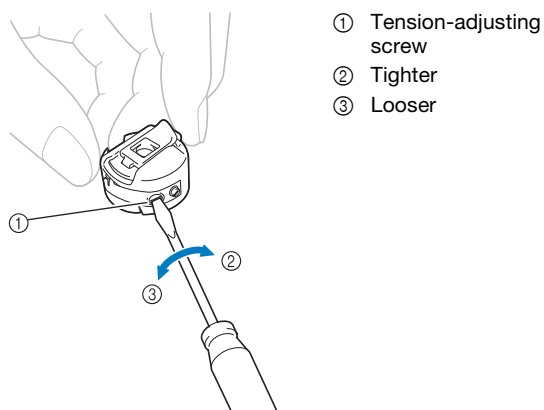

- 4 After making the adjustments, try embroidering to check the thread tension.

Adjusting the tension of the upper thread

When embroidering, the thread tension should be set so that the upper thread can be seen slightly on the wrong side of the fabric.

Note

- Always embroider a test sample prior to the final project. Adjust the thread tension if necessary.
- The thread tension knob has a very wide range for adjusting the thread tension.

- 1 Turn the thread tension knob.

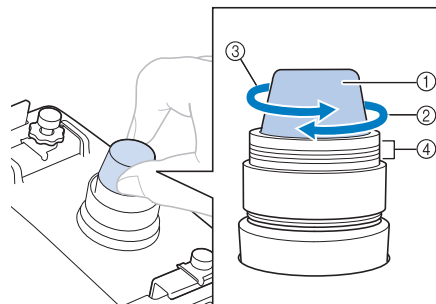

- If the thread tension is not still correctly adjusted, turn the upper thread guide pretension knob.

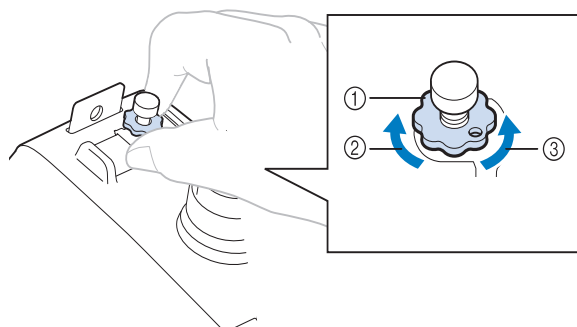

Correct Thread Tension

The pattern can be seen from the wrong side of the fabric. If the thread tension is not set correctly, the pattern will not finish well. The fabric may pucker or the thread may break.

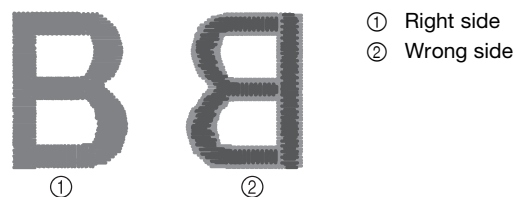

- Light gray color represents upper thread.
- Dark gray color represents bobbin thread.

Follow the operations described below to adjust thread tension according to the situation.

Note

- If you decrease the thread tension further than the red line, the tension knob may be disassembled. This is not a sign of a malfunction. Increase the thread tension slightly, and begin embroidering again.
- If necessary, refer to page 94 for reassembling the tension unit.

Upper thread is too tight

The tension of the upper thread is too tight, resulting in the bobbin thread being visible from the right side of the fabric.

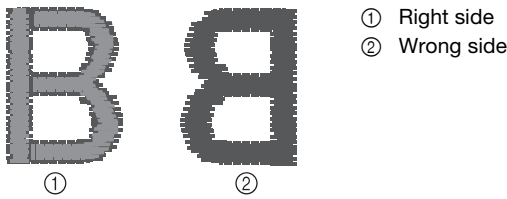

- Light gray color represents upper thread.
- Dark gray color represents bobbin thread.

Turn the knob in the direction of the arrow to decrease the tension of the upper thread.

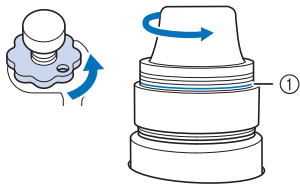

① Red line

If the red line is visible, the thread tension cannot be decreased any further. Increase the tension of the bobbin thread. (page 81)

Memo

- If you decrease the thread tension further than the red line, the tension knob may be disassembled.
- If necessary, refer to page 94 for reassembling the tension unit.

Upper thread is too loose

The tension of the upper thread is too loose, resulting in a loose upper thread, loose thread locks or loops appearing on the right side of the fabric.

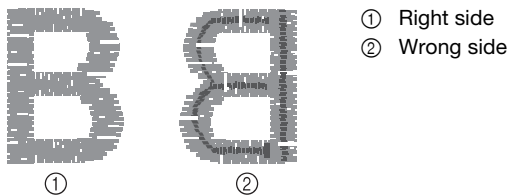

- Light gray color represents upper thread.
- Dark gray color represents bobbin thread.

Turn the knob in the direction of the arrow to increase the tension of the upper thread.

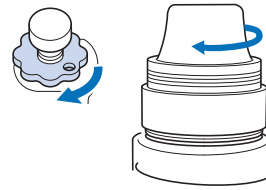

Uninterrupted embroidering (one color)

A selected pattern can be stitched out in one color instead of multiple colors. The machine will hesitate but not stop between color steps, and then continue until the pattern is completed.

1 Touch  in the embroidering screen.

- The selected pattern will be embroidered in one color, instead of changing the thread while embroidering.
- Touch  again to return to the pattern's original settings.

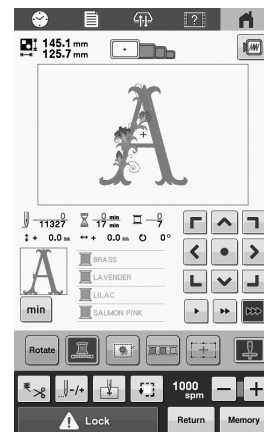
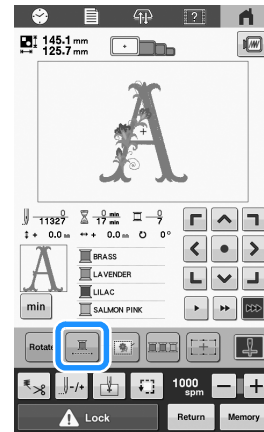

→ The thread color displayed on the screen will be grayed out.

Memo

- After finishing the embroidery, uninterrupted embroidering will be canceled.

Changing the display guides

The guides in the pattern display area can be specified. The machine automatically detects the type of Embroidery Frame Holder and embroidery frame that are installed and displays them.

- 1 Touch , and then display page 1 of the settings screen.

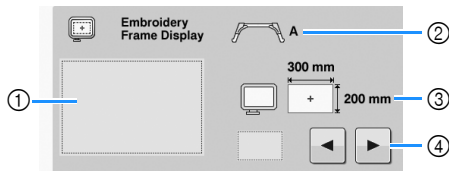





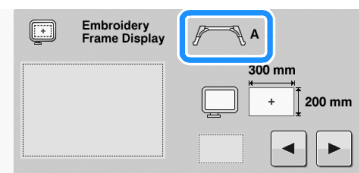

- ① How the guides will appear with the specified settings can be previewed here.
- ② Displays the type of the Embroidery Frame Holder.
- ③ Displays the size of the embroidery frame that is actually installed. (page 53)
- ④ Select the type of the center point marker and the grid lines and whether or not to display them.

■ Type of Embroidery Frame Holder

The machine automatically detects the type of Embroidery Frame Holder that is installed.

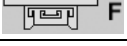

Embroidery Frame Holder A (included)	 A
Embroidery Frame Holder B (included)	 B
Embroidery Frame Holder C (Optional)	 C
Embroidery Frame Holder D (Optional)	 D
Embroidery Frame Holder E (Optional)	 E
Embroidery Frame Holder F (Optional)	 F
Cap frame/Cylinder frame (Optional)	
Magnetic Sash frame (Optional)	*

- * No icon appears since this frame is installed without an Embroidery Frame Holder.

■ [E OFF] setting

When embroidery frame holder E is installed, a setting ([E OFF]) can be selected, canceling embroidery frame detection.

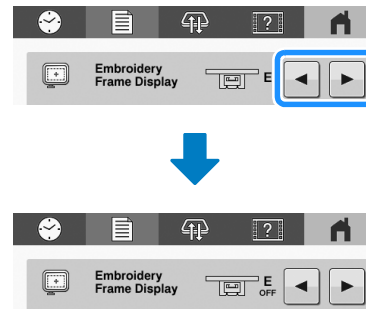

⚠ CAUTION

- If the [E OFF] setting is selected, be sure to check the embroidery frame and embroidery area before embroidering.

Changing the thread color information



You can display the name of the thread colors or embroidery thread number.

When the machine is purchased, the thread color number [#123] is selected.



Memo

- Colors on the screen may vary slightly from actual spool colors.
- Embroidering time of each thread color can be displayed by touching **min** in the pattern editing screen or embroidering screen. (page 35, page 56)

1 Touch , and then display page 1 of the settings screen.

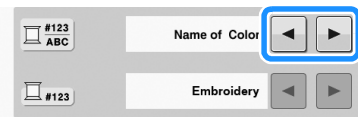
2 Touch  and  to display the name of the thread colors or the embroidery thread number.



3 When the thread number [#123] is displayed, touch  and  to select from the embroidery thread brand.



Memo

- The thread brand setting will be applied with the next pattern that is loaded.

Starting position settings



(page 22):

An instruction video is available for this topic.

1 Touch  in the embroidering screen.

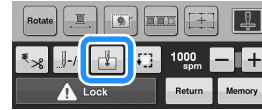

→ The starting position settings screen appears.

2 Touch the key for the desired starting position setting.

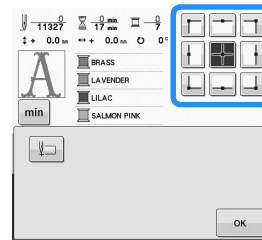

→ The highlighted key shows the currently selected setting.

Example: The following key is being selected.



→ The embroidery frame moves to the starting position.

3 After selecting the desired settings, touch .

→ The embroidering screen appears again.

■ Embroidering aligned characters

Follow the procedure described below to embroider aligned characters in a single row when the pattern extends beyond the embroidery frame.

Example: Aligning "DEF" to the characters "ABC"

A B C D E F

- 1 Select the character patterns for "ABC".

- 2 Touch  in the embroidering screen.

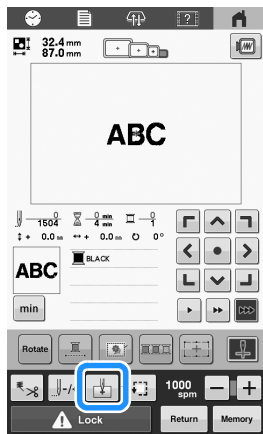

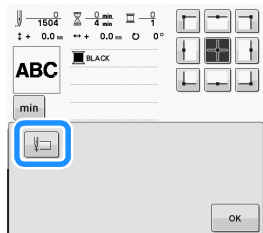

- 3 Touch .





→ The starting point is set at the lower-left corner of the pattern. The embroidery frame moves so that the needle drop point is at the set point.

Memo

- To cancel aligning the character patterns and return the starting point to the center of the pattern, touch .
- Use  to select a different starting point for embroidering.

- 4 Touch  to return to the embroidering screen.

→  changes to  while the starting point is set in the lower-left corner of the pattern.

- 5 Touch , and then press the "Start/Stop" button to start embroidering.

- 6 After the characters are embroidered, cut the threads to a generous length, remove the embroidery frame, and then attach the embroidery frame again so that the remaining characters ("DEF") can be embroidered.

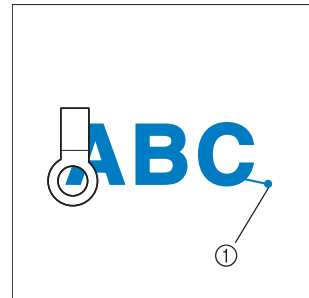

- 7 As in step 1, select the character patterns for "DEF".

- 8 In the embroidering screen, touch .

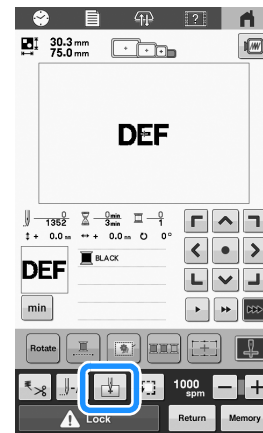

- 9 Touch .

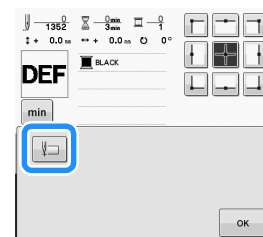

→ The needle bar is positioned in the lower-left corner of the pattern. The embroidery frame moves so that the needle is positioned correctly.

- 10 Touch .

- 11 Use  to align the needle with the end of embroidering for the previous pattern.

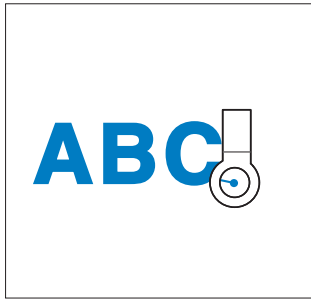

- 12 Touch , and then press the “Start/Stop” button to begin embroidering the remaining character patterns.



USING THE MEMORY FUNCTION

Memo

- For the pattern storage capacity and usable media, refer to “SPECIFICATIONS” on page 107.

Saving embroidery patterns

Note

- Do not turn the main power to OFF while the [Saving...] screen is displayed. You will lose the pattern you are saving.
- For details on supported computers, refer to “SPECIFICATIONS” on page 107.

- 1 Touch  when the pattern you want to save is in the embroidering screen.

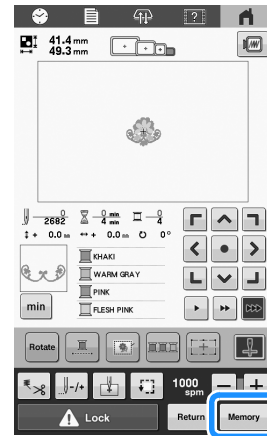

- 2 Touch the desired destination to start saving.

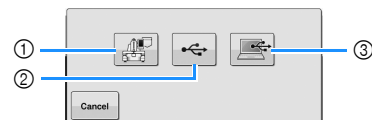

- 1 Save to the machine's memory.
- 2 Save to the USB media. The pattern is saved in a folder labeled [bPocket].
When saving the embroidery pattern in a USB media, insert the USB media into the USB port on the machine.

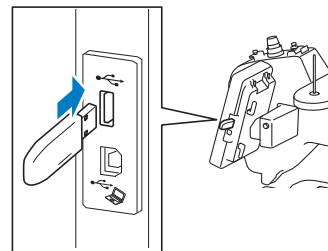

- 3 Save to the computer.
When saving the embroidery pattern to a computer, use the included USB cable to connect the machine to the computer. The machine will be recognized as a temporary, “Removable Disk” on the computer.

- The file will be saved to “Removable Disk”. To save the file to a more permanent folder in the computer, open File Explorer, select “Removable Disk”, then copy the file to the destination folder.

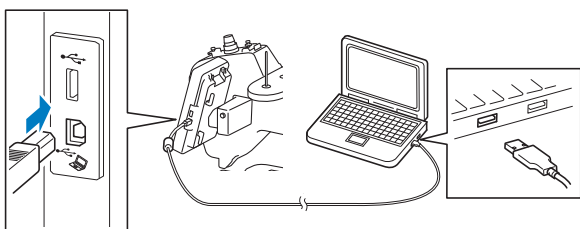

Retrieving embroidery patterns

- 1 Touch the desired destination, and then select the desired embroidery pattern.

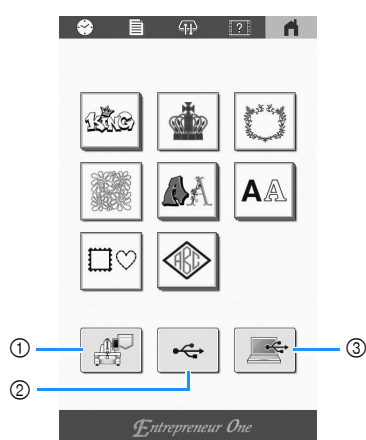

- 1 Retrieve from the machine's memory.
- 2 Retrieve from a USB media.
When retrieving the patterns from a USB media, insert the USB media into the USB port on the machine.
- 3 Retrieve from a computer.
When retrieving the patterns from a computer, use the included USB cable to connect the computer and the machine. Plug the USB cable connector into the corresponding USB ports for the computer and for the machine. Copy the embroidery pattern file to “Removable Disk” that has been assigned to the embroidery machine.

Memo

- If the embroidery pattern to be retrieved is in a folder of the USB media, touch the key for that folder. Touch to return to the previous screen.

- 2 Touch .



- * Touch to delete the embroidery pattern.

EMBROIDERY APPLICATIONS

Embroidering split (large-size) patterns

Split (large-size) patterns created with PE-DESIGN version 7 or later can be embroidered. With large-size patterns, embroidery designs larger than the embroidery hoop are divided into multiple sections, which combine to create a single pattern after each section is embroidered.

For details on creating large-size embroidery patterns and for more detailed embroidering instructions, refer to the manual included with PE-DESIGN version 7 or later.

The following procedure describes how to read the large-size embroidery pattern shown below from USB media and embroider it.

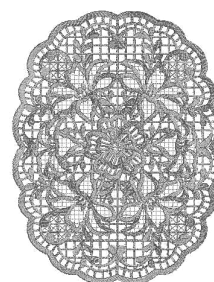

- 1 Connect to the machine the media containing the created large-size embroidery pattern, and then select the large-size embroidery pattern to be embroidered.

* For details on retrieving patterns, refer to page 88.

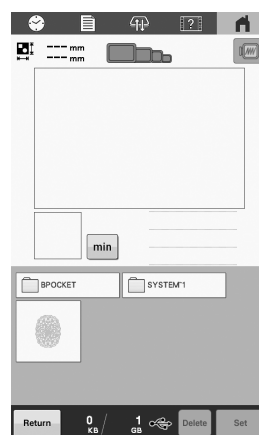

→ A screen appears so that a section of the large-size embroidery pattern can be selected.

2 Select section  to be embroidered, then touch



- Select the sections in alphabetical order.

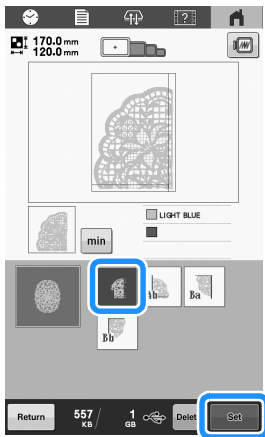

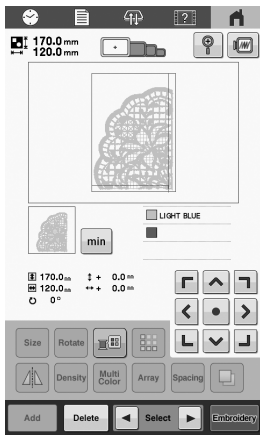

3 If necessary, edit the pattern.



- For details, refer to “EDITING THE EMBROIDERY PATTERN” on page 35.

4 Touch .

5 Touch , and then press the “Start/Stop” button to embroider the section.

6 When embroidering is finished, the following message appears. Touch .

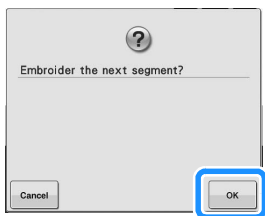

→ A screen appears so that a section of the large-size embroidery pattern can be selected.

7 Repeat steps **2** to **6** to embroider and combine the remaining sections of the pattern.

Chapter 4 APPENDIX

MAINTENANCE

Simple machine maintenance operations are described below. Always keep the machine clean, otherwise malfunctions may occur.

⚠ CAUTION

- **Unplug the power supply cord before cleaning the machine, otherwise injuries or shock may occur.**

Cleaning the LCD

If the surface of the LCD is dirty, lightly wipe it with a soft dry cloth.

Cleaning the machine surface

To remove dirt from the machine, use a soft cloth that has been soaked in lukewarm water and thoroughly wrung dry. After cleaning the machine, dry with a soft, dry cloth.

Cleaning the hook

Periodically remove lint and dust for better performance from the Hook race area.

Use the included cleaning brush.

- 1 Set the main power switch to "O" to turn off the machine.
- 2 Open the hook cover, and remove the bobbin case. (page 23)

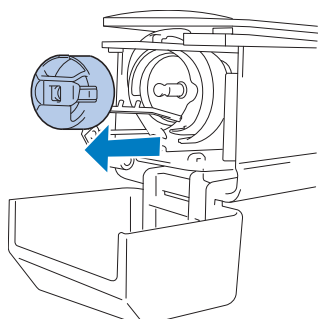

- 3 Use the included cleaning brush to remove any lint and dust from the hook and the surrounding area.

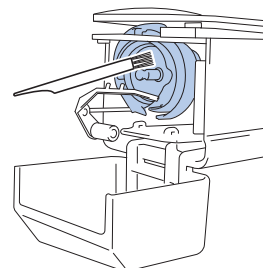

Note

- If the hook is scratched or damaged, consult your authorized Brother dealer.

- 4 After cleaning is finished, insert the bobbin case into the hook, and then close the hook cover. (page 28)

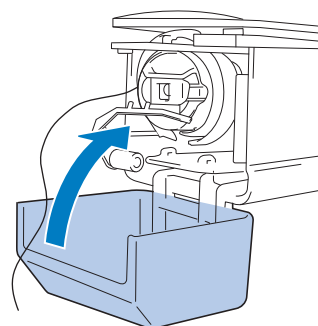

Cleaning around the needle plate

If lint and dust collect around the moving knife, the fixed knife or the thread retaining plate, the thread may not be cut correctly and various parts of the machine may be damaged. Make sure to clean around the needle plate once a month. Use the included 3-way screwdriver and cleaning brush.

- 1 Set the main power switch to "O" to turn off the machine.

- 2 Remove the needle plate.

With the 3-way screwdriver, loosen the screws, remove the needle plate.

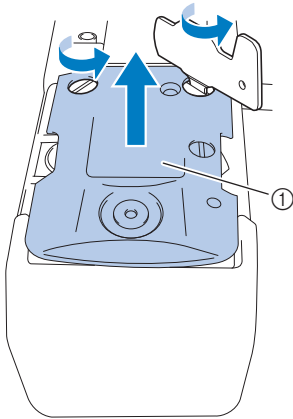

① Needle plate

- 3 Use the included cleaning brush to remove any lint and dust from the moving knife, the fixed knife, the thread retaining plate, and the surrounding areas.

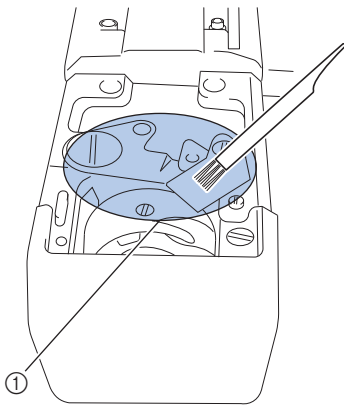

① Remove all lint in this area

- 4 Attach the needle plate in the opposite way that it was removed in step 2, and then close the hook cover.

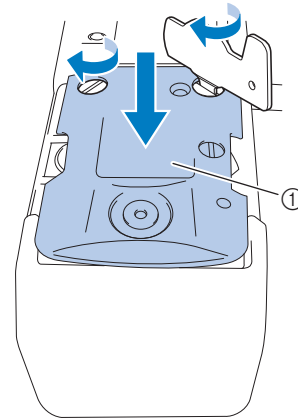

① Needle plate

Cleaning the bobbin case

Thread wax and dust easily collect around the hole in the tension-adjusting spring on the bobbin case, resulting in an incorrect thread tension. Therefore, it should be cleaned each time the bobbin is changed.

Use a piece of paper the thickness of a business card.

- 1 Open the hook cover, remove the bobbin case, and then remove the bobbin. (page 23)

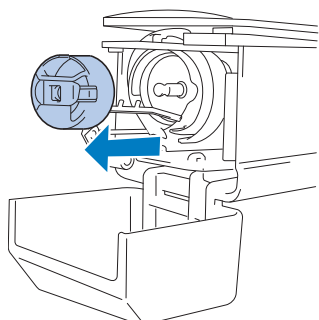

- 2 Slide the paper under the tension-adjusting spring to remove any dust.

Use a corner of the paper to remove any dust from around the hole.

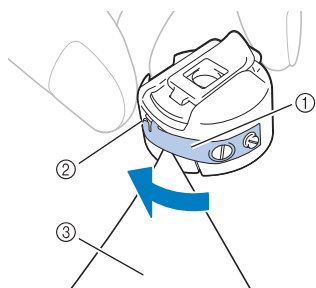

- ① Tension-adjusting spring
- ② Hole
- ③ Paper

IMPORTANT

- Do not bend the tension-adjusting spring. In addition, do not use anything other than thick paper or paper of the specified thickness to clean the bobbin case.

- 3 Use the included cleaning brush to remove any lint and dust from inside the bobbin case.

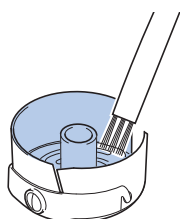

- 4 After cleaning is finished, insert the bobbin into the bobbin case and the bobbin case into the hook, and then close the hook cover. (page 27)

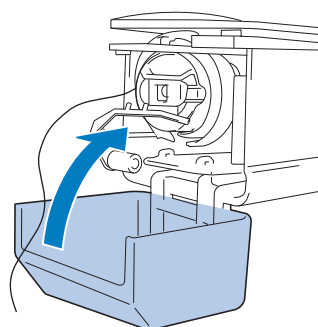

Cleaning the thread paths of the upper threads

If dust or lint has accumulated in the thread guides or tension unit in the paths of the upper threads, the thread may break while embroidery is being performed. Periodically clean the thread paths.

■ Cleaning the thread guides

- 1 Use the included cleaning brush to remove any lint and dust from below the thread guide plates.

Clean the thread guide plates for both the upper thread guide and the middle thread guide.

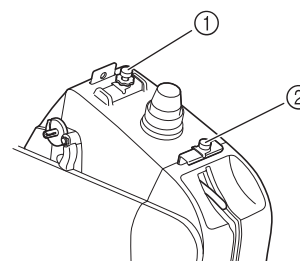

- ① Upper thread guide
- ② Middle thread guide

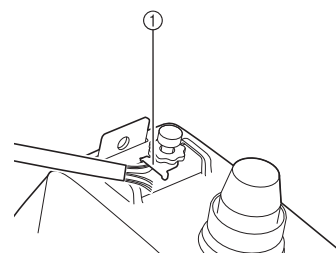

- ① Thread guide plate

■ Disassembling and cleaning the tension unit

- 1 To remove the thread tension knob, turn it counterclockwise as shown on the illustration.

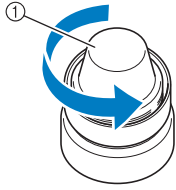

① Thread tension knob

- 2 Using the included cleaning brush, remove any lint and dust from the two pieces of tension disc washers (top, bottom) inside the thread tension knob.

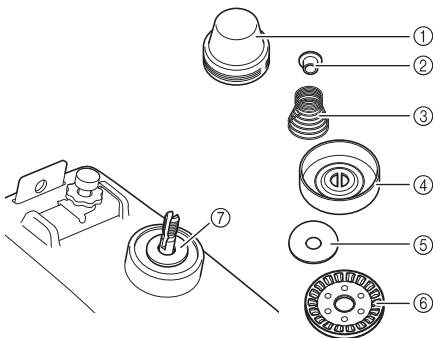

- ① Thread tension knob
- ② Nylon shoulder washer
- ③ Tension spring
- ④ Tension base spring
- ⑤ Tension disc washer (top) (thinner than nylon washer)
- ⑥ Tension disc
- ⑦ Tension disc washer (bottom) (thinner than nylon washer)

- 3 Reassembling the tension unit.

Note

- When reassembling the tension unit, be sure not to install the tension disc upside-down. There is a magnet on the bottom.

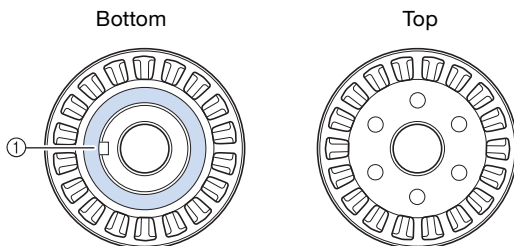

① Magnet

- When reassembling the tension unit, be careful not to lose any parts or install any parts in an incorrect order. The machine may not operate correctly if the tension unit is incorrectly reassembled.

Replacing the needle



(page 22):

An instruction video is available for this topic.

⚠ CAUTION

- Be sure to turn off the machine before replacing the needle, otherwise injuries may result if the machine starts embroidering.
- Never use bent needles. Injuries may result.

Memo

- Your machine is designed to use household embroidery needles. The factory recommended needle is “HAX 130 EBBR” (Organ). Schmetz needles 130/705 H-E may be used as a substitute.
- To check the needle correctly, place the flat side of the needle on a flat surface. Check the needle from the top and the sides. Throw away any bent needles.

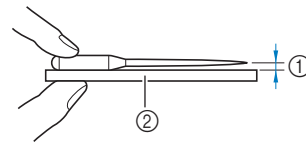

- ① Parallel space
- ② Flat surface (glass, etc.)

- 1 Set the main power switch to “O” to turn off the machine.

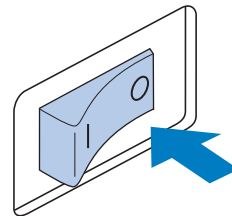

- 2 Loosen the needle set screw and remove the needle.

Hold the needle with your left hand, and then hold the Allen screwdriver in your right hand and turn the needle set screw counterclockwise.

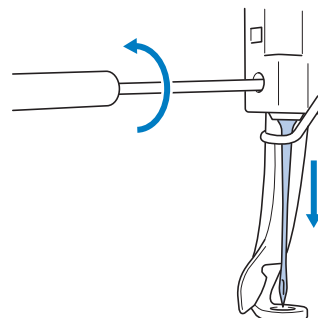

Note

- Be sure to use the included Allen screwdriver to replace the needle.

- Do not apply extreme force when loosening or tightening the needle set screw, otherwise the machine may be damaged.

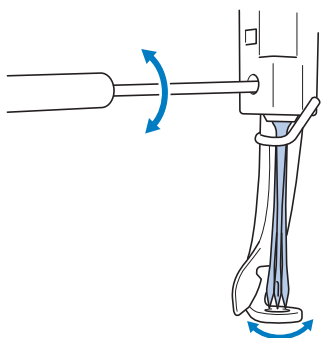

- 3** With the flat side of the needle toward the back of the machine, insert the needle all the way up until it touches the needle bar stopper.

Pass the needle through the hole in the presser foot, and then use the needle changing tool to lift up the needle.

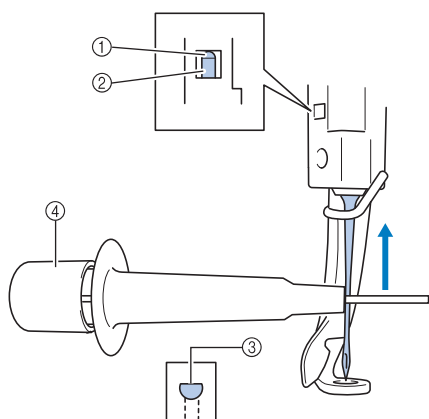

- ① Needle bar stopper
- ② Needle
- ③ Flat side of needle
- ④ Needle changing tool

Hold the needle changing tool and press the end of the needle changing tool ① in to extend the needle-mounting clamp ②. Attach the clamp to the needle, and then release the pressed area to clamp the needle. To unclamp the needle, press ① again.



- ① End of the needle changing tool
- ② Needle mounting clamp

- 4** While holding the needle in place with your left hand, tighten the needle set screw.

Use the Allen screwdriver to turn the needle set screw clockwise.

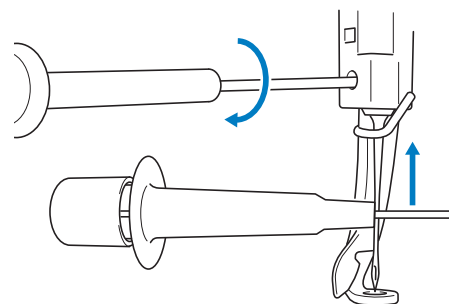

⚠ CAUTION

- Be sure to insert the needle in the needle bar chamber until it reaches the needle bar stopper and securely tighten the needle set screw with the Allen screwdriver, otherwise the needle may break and cause injury.

4

IMPORTANT

- If the needle is not fully inserted, the hook of the automatic needle-threading mechanism will not pass through the eye of the needle during automatic needle threading, and the hook may bend or the needle cannot be threaded.
- If the hook of the automatic needle-threading mechanism is bent or damaged, contact your authorized Brother dealer.

Oiling the machine



(page 22):
An instruction video is available for this topic.

In order to extend the life of the machine's parts and keep the machine operating correctly, be sure to oil the machine before the first time that it is used.

IMPORTANT

- Put a drop of oil onto the hook before use.
- Apply one drop of oil on the lower needle bar above the felt washer every 40 – 50 hours of embroidering time.
- Apply only machine oil. Use of any other type of oil may result in damage to the machine.
- Do not apply too much oil. Fabric or thread may get contaminated. If too much oil is applied, wipe off any excess with a rag.
- If the thread breaks while embroidering or the operating noise of the hook becomes loud, apply oil onto the race hook.

■ Oiling the race

- 1 Set the main power switch to "O" to turn off the machine.
- 2 Open the hook cover, and remove the bobbin case. (page 23)

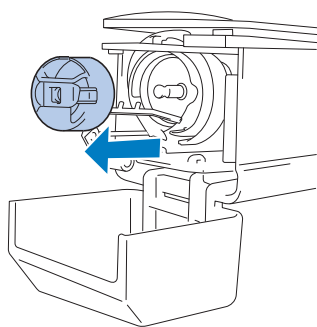

- 3 Rotate the handwheel till the notch aligns with the marked position (▶) on the machine.

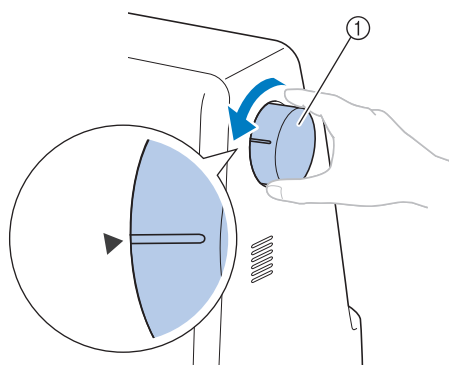

- ① Handwheel
- Be sure to rotate the handwheel toward the LCD panel (counterclockwise).

- 4 Put a drop of oil onto the hook.

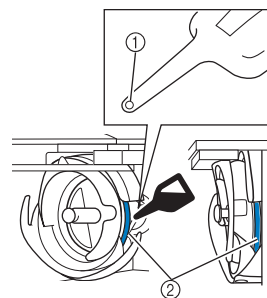

Front angle view

Side view

- ① Punch a small hole in oil bottle.
- ② Apply oil here.
 - Use a pointed object to punch a small hole in the tip of the included oiler before using it.

- 5 After oiling, insert the bobbin case into the hook, and then close the hook cover. (page 28)

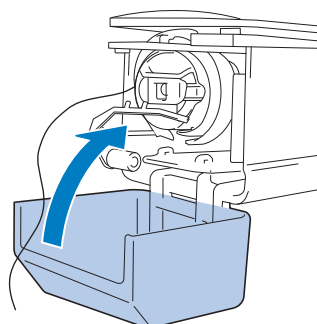

■ Oiling the needle bar

Rotate the handwheel toward the LCD panel till the notch aligns with the marked position (▶) on the machine, bringing the needle bar to its lowest position. Put one drop of oil, as high as possible, on the needle bar above the felt washer.

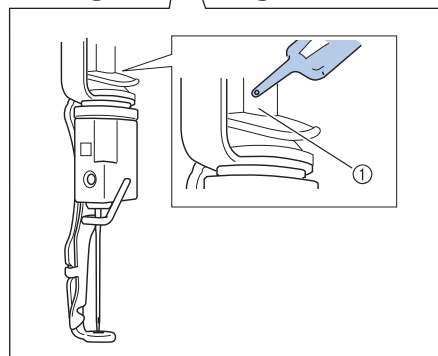
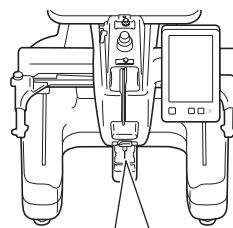

- ① Apply oil here.
 - Too much oil may drip onto embroidery project.

About the maintenance message



Once this message appears, it is recommended to take your machine to your nearest authorized Brother dealer for a regular maintenance check. Although this message will disappear and the machine will continue to function once you touch , the message will display several more times until the appropriate maintenance is performed.

Please take the time to arrange for the maintenance that your machine requires as soon as this message appears. Such steps will help to ensure you receive continued, uninterrupted hours of machine operation for the future.

Replacing the hook of the automatic needle-threading mechanism



(page 22):
An instruction video is available for this topic.

When replacing the hook, use the threader hook included with the machine.

If you cannot thread the machine, even after replacing the threader hook, contact your authorized Brother dealer.

- 1 Touch  to display the machine help screen, and then touch .

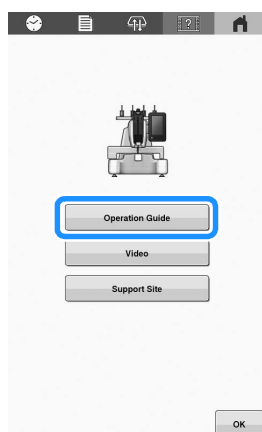

- 2 Touch .

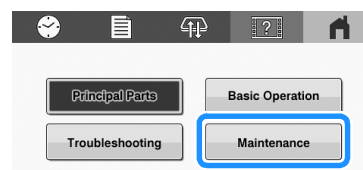

- 3 Touch .



- 4 Use the QR code that appears in the screen to access instruction videos for the machine.

- 5 Follow the instruction video to replace the hook of the automatic needle-threading mechanism.

BEFORE LENDING OR DISPOSING OF THE PRODUCT

Please be sure to reset the settings of your machine to delete the following data.

- all saved data
- customized settings

1 Touch , and then touch  beside [Reset to Default].

2 Touch .

Note

- Do not turn the main power to OFF while the [Deleting...] screen is displayed.

TROUBLESHOOTING



If the machine stops operating correctly, check the following possible problems before requesting service. You can solve most problems by yourself. If you need additional help, the Brother support website offers the latest FAQs and troubleshooting tips. Visit us at <https://s.brother/cpcab/>.

If the problem persists, contact your authorized Brother dealer or the nearest Brother authorized service center.

List of Symptoms

If you have a minor problem with your machine, check the following solutions.

If the reference page is "*" or the suggested remedy does not correct the problem, contact your authorized Brother dealer.

Touch  →  →  for advice about minor embroidering problems during embroidering.

Touch  at any time to return to the original screen.

Symptom		
	Probable Cause/Remedy	Page
The machine does not operate.		
	The machine is not turned on.	18
	The machine has not been unlocked.	67
	The "Start/Stop" button was not pressed.	67
The embroidery frame cannot be attached to the machine.		
	The Embroidery Frame Holder attached to the machine is not appropriate for the selected embroidery frame.	53
The embroidery frame cannot be removed or attached.		
	Depending on the position where the machine's carriage has stopped, it may be difficult to remove or attach the embroidery frame. <ul style="list-style-type: none"> • Touch  to position the carriage, so the embroidery frame can easily be removed or attached. 	53
The needle breaks.		
	The needle is not installed correctly.	94
	The needle set screw is loose.	94
	The needle is bent or blunt.	94

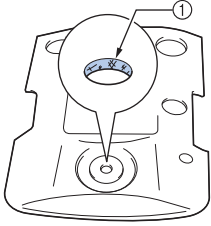
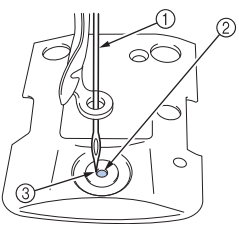
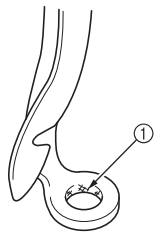
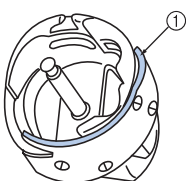
Symptom		
Probable Cause/Remedy	Page	
<p>The area around the hole in the needle plate is damaged.</p>  <p>① Scratches/Burrs</p> <ul style="list-style-type: none"> • Replace the needle plate. 	*	
<p>The needle hits/touches the needle plate.</p>  <p>① Needle ② Hole in needle plate ③ Needle hits hole</p> <ul style="list-style-type: none"> • Replace the needle. 	94 *	
<p>The presser foot is set too high and not correctly positioned. The needle hits/touches the presser foot.</p>	*	
<p>The area around the presser foot hole is damaged.</p>  <p>① Scratches/Burrs</p> <ul style="list-style-type: none"> • Replace the presser foot. 	*	
<p>Sliding surface on hook race is not smooth. There are scratches or burrs on it.</p>  <p>① Hook race area</p>	*	
<p>The bobbin or bobbin case is not correctly installed.</p>	23, 28	
<p>The hook is not correctly installed.</p>	*	

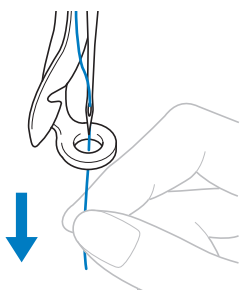
Symptom		
Probable Cause/Remedy	Page	
The needle breaks.		
<p>The hook stopper is not correctly installed, the hook is making a complete rotation.</p>	*	
<p>The upper thread is not threaded correctly. The upper thread is catching somewhere.</p>  <ul style="list-style-type: none"> • Pull the upper thread by hand from below the presser foot, and check that the thread moves smoothly. If the thread does not move, it is not threaded correctly. Thread the upper thread correctly. Make sure the thread is caught by the needle bar thread guide. 	62	
<p>The upper thread tension is set too high.</p>	82	
<p>A bobbin designed specifically for this machine is not used.</p>	23	
<p>The needle and the hook are not correctly passing each other. • Hook timing may be OFF.</p>	*	
<p>The thread density of the embroidery data is too fine. Three or more overlapping stitches are being embroidered. • Using a data design system, correct the thread density and over stitching settings in the embroidery data.</p>	107	
The thread is not cut automatically.		
<p>Lint or dust has accumulated around the needle plate (moving knife, fixed knife or thread retaining plate).</p>	92	
<p>A bobbin case designed specifically for this machine is not used. • Use the correct bobbin case.</p>	—	
<p>Lint or dust has accumulated in the thread tension disc.</p>	94	
After the threads are automatically cut, the upper thread is too short and comes out of the needle.		
<p>Lint or dust has accumulated around the needle plate (moving knife, fixed knife or thread retaining plate).</p>	92	

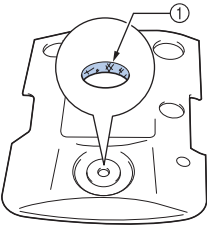
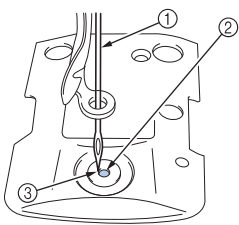
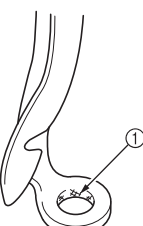
Symptom		
	Probable Cause/Remedy	Page
The upper thread breaks.		
	The needle is not correctly installed.	94
	The needle set screw is loose.	94
	The needle is bent or blunt.	94
	The area around the hole in the needle plate is damaged.	*
	 <p>① Scratches/Burrs</p> <ul style="list-style-type: none"> • Replace the needle plate. 	
	The needle is touching the needle plate.	*
	 <p>① Needle ② Needle plate hole ③ Needle touching hole</p>	
	The presser foot is set too high and not correctly positioned. The needle hits/touches the presser foot.	*
	The area around the presser foot hole is damaged.	*
	 <p>① Scratches/Burrs</p> <ul style="list-style-type: none"> • Replace the presser foot. 	
	Using a specialty thread like a metallic thread.	56
	<ul style="list-style-type: none"> • Slow down the machine embroidery speed. 	

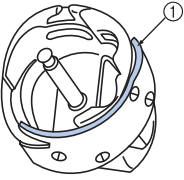
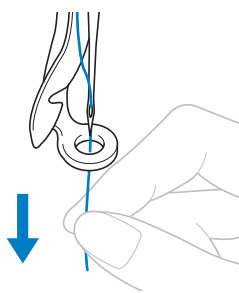
Symptom		
	Probable Cause/Remedy	Page
The upper thread breaks.		
	Sliding surface on hook is not smooth. There are burns on it.	*
	 <p>① Hook race area</p>	
	The thread is loose in the hook area.	91
	The play between the hook and the race is too much.	*
	The hook does not rotate smoothly.	91, 96
	<ul style="list-style-type: none"> • Remove lint, clean and apply oil. 	
	The space between the hook stopper and the hook cannot be adjusted.	*
	The upper thread is not threaded correctly.	62
	 <ul style="list-style-type: none"> • Pull the upper thread by hand from below the presser foot, and check that the thread moves smoothly. If the thread does not move smoothly, it is not correctly threaded. Un-thread the machine and re-thread the machine. Make sure the thread is correctly positioned in the needle bar thread guide. 	
	Upper thread is not positioned in upper or middle guide plate.	62
	<ul style="list-style-type: none"> • Make sure thread passes completely under upper and middle guide plate. 	
	There are knots or tangles in the thread.	—
	<ul style="list-style-type: none"> • Remove any knots or tangles. 	
	The upper thread tension is too high.	82
	The bobbin thread tension is incorrect. The thread does not roll out of the bobbin case smoothly.	81
	The bobbin case is damaged.	23
	<ul style="list-style-type: none"> • Replace the bobbin case with a new one. 	
	The bobbin thread is not wound correctly.	23
	<ul style="list-style-type: none"> • Check that the bobbin is wound so that it is about 80% full and that the thread is evenly wound. If the bobbin is not correctly wound, replace the bobbin with one that is correctly wound or rewind the bobbin. 	

Symptom	
Probable Cause/Remedy	Page
A bobbin designed specifically for this machine is not used.	23
The automatic needle-threading mechanism is broken.	*
Adhesive is attached to the needle. • Replace the needle.	94
The fabric is not taut.	48, 49
The thread quality is poor. • The thread quality is too weak due to age of thread. Replace thread.	—
The thread density of the embroidery data is too fine. Three or more overlapping stitches are being embroidered. • Using a data design system, correct the thread density and over stitching settings in the embroidery data.	107
Lint or dust has accumulated in the thread tension disc.	94
The bobbin thread breaks.	
The bobbin thread is not correctly threaded.	27
The bobbin is scratched or does not rotate smoothly. • Replace the bobbin.	23
The bobbin case is damaged. • Replace the bobbin case.	23
The thread is tangled.	91
A bobbin designed specifically for this machine is not used.	23
Lint or dust has accumulated in the thread tension disc.	94
Stitches are skipped.	
The upper thread is not threaded correctly.	62
The needle is bent or blunt.	94
The needle is not installed correctly.	94
Dust has accumulated under the needle plate or in the hook.	91, 92
The needle and the hook are not correctly passing each other.	*
The thread twist is either too tight or too loose. • Improper twisting results in irregular loop formation. Try using a new spool.	—

Symptom	
Probable Cause/Remedy	Page
The embroidery pattern is misaligned.	
The thread is tangled. • Use tweezers to remove any tangled thread from the hook.	—
The fabric is not secured in the embroidery frame (for example, the fabric is not taut).	48, 49
The embroidery frame is too large for the size of the embroidery.	53
The thumb screws on the Embroidery Frame Holder are loose.	17
Appropriate stabilizer (backing) is not used.	47
The embroidery frame is not correctly attached to the carriage. • Correctly attach the embroidery frame to the carriage. Make sure that the pins on the left and right arms of the Embroidery Frame Holder securely fit into the holes in the handles on the embroidery frame.	52
The carriage or the embroidery frame is hitting objects. • The pattern may become misaligned if the carriage or embroidery frame is hitting objects.	—
The fabric is caught or pinched. • Stop the machine, and then correctly position the fabric.	—
The carriage moved while removing embroidery frame. • The pattern may become misaligned if the presser foot was hit or the carriage was moved while embroidery. • Be careful when removing and reattaching the embroidery frame while embroidery. If the carriage is moved, turn the machine off, then on again. The correct frame position at the time that the machine was stopped is stored in the machine's memory, and the embroidery frame is returned to the correct position.	—
The design was not digitized correctly. • The design may need more pull compensation or underlay to accommodate stretchy or high-napped fabrics.	—
The size of the installed embroidery frame is not correctly detected.	
The thumb screws on the Embroidery Frame Holder are loose.	17
The starting position for the embroidery frame is horizontally misaligned.	
The thumb screws on the Embroidery Frame Holder are loose.	17

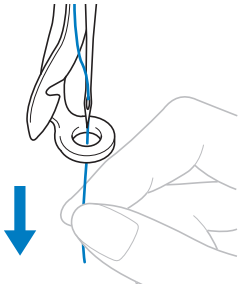

Symptom		
	Probable Cause/Remedy	Page
There are loops in the upper thread.		
	<p>The upper thread tension is low.</p>  <ul style="list-style-type: none"> After passing the upper thread through the hole in the presser foot, pull the thread by hand to check the thread tension. 	—
	<p>The thread tension does not correspond to the amount that the thread tension knob was tightened.</p> <ul style="list-style-type: none"> If the thread tension cannot be adjusted, thread wax and dust may have collected in the upper or middle thread guides, causing the thread guide plates to rise. Clean the thread guide plates. 	93
	<p>Thread is not correctly threaded around the thread tension disc.</p> <ul style="list-style-type: none"> Clean the thread tension disc. Rethread and make sure the thread tension disc rotate when pulling on thread. 	94
	<p>The thread quality is poor.</p> <ul style="list-style-type: none"> Try embroidery with different thread. If the problem no longer occurs after the thread is changed, the thread quality is the problem. Replace the thread with one of good quality. 	—
The machine is noisy.		
	Lint may be wound in the hook.	91
	The upper thread is not threaded correctly.	62
	<p>The hook is damaged.</p> <ul style="list-style-type: none"> Replace the hook. 	*
	Not enough oil was applied.	96
The needle threader cannot be used.		
	Recommended needles are not used on this machine.	94
	The needle is not installed correctly.	94
	The hook of the automatic needle-threading mechanism is bent.	97



Symptom		
	Probable Cause/Remedy	Page
The thread tension is incorrect.		
	The upper thread is not threaded correctly.	62
	The bobbin thread is not correctly threaded.	27
	The bobbin thread tension is incorrect.	81
	Lint or dust has accumulated in the thread tension disc.	94
The upper thread does not reach the bobbin thread when embroidering begins.		
	<p>There is no more thread in the bobbin, the thread does not feed from the bobbin, or the thread that is fed from the bobbin is too short.</p> <ul style="list-style-type: none"> Correctly thread the bobbin thread. 	27
Although the thread is not broken, a broken thread error occurs and the machine stops.		
	<p>If the thread breakage sensor in the thread tension disc of the thread tension knob cannot detect that the thread is being fed, even if the machine is running, a broken thread error occurs and the machine is stopped.</p> <ul style="list-style-type: none"> Correctly pass the thread through the thread tension disc. If the broken thread error occurs after the machine is rethreaded, the sensor may be damaged. 	63 *
The thread is worn.		
	Lint or dust has accumulated in the thread tension disc.	94
Jump stitches are long.		
	Lint or dust has accumulated in the thread tension disc.	94
	Long jump stitches have been specified.	59
There are needle cuts or holes in the garment.		
	<p>The needle is dull.</p> <ul style="list-style-type: none"> Replace the needle. Dull needles have a difficult time passing through the garment, causing fabrics to tear. 	94
	<p>The fabric is too delicate.</p> <ul style="list-style-type: none"> The simple penetration of the needle could damage delicate fabrics. Use stabilizer on top of fabric. 	—



Symptom	
Probable Cause/Remedy	Page
Fabric is puckering.	
<p>The thread tension is too tight.</p> <ul style="list-style-type: none"> Adjust the tension according to the type of fabric and thread being used. Polyester thread will stretch during embroidery especially if the tensions are set too high. After the stitching is complete, the thread returns to its original strength, causing puckers in the fabric. 	82
<p>The framing tension of the fabric is incorrect.</p> <ul style="list-style-type: none"> Tightly frame non-stretchable, woven fabrics. Loose framing will cause the fabric to bunch up under the stitching. Tautly frame soft knits using a stable backing. Overstretching the garment will cause it to look puckered when the frame is removed. 	—
<p>The column stitches are too long.</p> <ul style="list-style-type: none"> Re-digitize the design with fill stitching or with multiple rows of column stitching. 	—
<p>The needle is dull.</p> <ul style="list-style-type: none"> Dull needles push fabric down and damage material. Replace the needle. 	94
The LCD cannot be read.	
<p>The LCD screen is too bright or too dark.</p> <ul style="list-style-type: none"> Adjust the brightness of the screen display. 	21
When embroidering thick fabric, the fabric cannot be correctly hooped.	
<p>Fabric slips within the frame because of its thickness.</p> <ul style="list-style-type: none"> Wrap masking tape or bias tape around the outer frame. The tape will provide resistance so that the fabric does not easily slip. 	—
The Embroidery Crosshair Positioning Laser is hard to see.	
<p>The Embroidery Crosshair Positioning Laser is too bright or too dim.</p> <ul style="list-style-type: none"> Adjust the brightness of the Embroidery Crosshair Positioning Laser. 	60
When the machine is connected to your computer with the USB cable, "Removable Disk" is unusable.	
<p>Disconnect the USB cable connecting the computer and the machine, and then reconnect cable to the machine.</p>	—

Error messages

If the "Start/Stop" button is pressed while the machine is not correctly set up or if an incorrect operation is performed, the machine stops and informs you of the error with a buzzer and an error message. If an error message appears, correct the problem according to the instructions in the message.

To close the message, touch  or perform the correct operation, then touch . If the message appears again, consult your nearest authorized Brother dealer.

	Error messages	Cause/solution
1	Cannot change the configuration of the characters.	This message is displayed when there are too many characters in the curved text arrangement. Change the text arrangement or the embroidery frame.
2	Cannot recognize the data for the selected pattern. The data may be corrupted. Please turn off the power and turn on again.	This message is displayed when trying to recall damaged pattern data or data created using another manufacturer's data design system. Turn the machine off, then on again to return it to its normal condition.
3	Change to a larger embroidery frame.	This message is displayed when the thumb screws of the Embroidery Frame Holder are loose. Using the included 3-way screwdriver, firmly tighten the two thumb screws. (page 52)
		This message is displayed when the installed embroidery frame is too small. Check which embroidery frames can be used, and then install a larger embroidery frame. (page 49)
4	Check upper and bobbin thread.	This message is displayed when the thread tension is too tight. Check the tensions of the upper thread and bobbin thread, and then adjust them. (page 81)
		This message is displayed when the upper thread breaks or the thread comes out of the thread tension disc or a thread guide. Check that the thread passes under the upper and middle thread guides, and correctly thread the upper thread. (page 62)
		This message is displayed when lint or dust has accumulated in the thread tension disc. Remove the thread tension knob, and then remove any lint or dust accumulated between the tension disc washers. (page 94)
		This message is displayed when the bobbin thread breaks or runs out. Check that there is thread on the bobbin and that approximately 50 mm (approx. 2 inches) of thread has been pulled out, and then re-install the bobbin. (page 23)
		This message is displayed when there may be another cause. Refer to "The upper thread breaks." on page 100 or "The bobbin thread breaks." on page 101. Touch  to advance or reverse through the stitching. (page 69)
5	Failed to save file.	This message is displayed when you try to save more than 100 settings screen image files in the USB media. In this case, delete a file from the USB media or use different USB media.
6	Go to Embroidering Screen and press the unlock key.	This message is displayed when the thread trimming button is pressed while a screen other than the embroidering screen is displayed. Display the embroidering screen.
7	Inappropriate needle stop position	This message is displayed when the needle has stopped at an incorrect position. Turn the handwheel so that the mark on the handwheel is at the top, and then touch  .
8	Needle threader error	This message is displayed when the automatic needle-threading mechanism does not operate correctly. Remove the thread entangled in the automatic needle-threading mechanism, and then touch  .
9	Needle threader is in threading position.	This message is displayed when another operation is performed while the automatic needle-threading mechanism is threading the needle. Press the automatic needle-threading button, and then perform the other operation after the needle is threaded. (page 65)

	Error messages	Cause/solution
10	OK to recall and resume previous memory?	This message is displayed when the machine is turned off, then on again before embroidering is completed. Touch  to resume embroidering. If the embroidering screen was displayed before the machine was turned off, back up several stitches, and then continue embroidering. (page 71)
11	OK to separate the combined border pattern?	This message is displayed when a combined border pattern is being rotated in the embroidering screen.
12	Picker error	This message is displayed when the thread picker (page 23) does not operate correctly. Remove the thread entangled on the thread picker, and then touch  .
13	Press the unlock key to unlock the machine.	This message is displayed when the thread trimming button is pressed before the machine is unlocked. Touch  to use the thread trimming function.
14	Preventive maintenance is recommended.	This message is displayed when the machine needs maintenance. (page 97)
15	The pattern combination is too large for the extra large embroidery frame. If you plan to add more patterns, rotate the pattern combination.	This message is displayed when a long vertical pattern is recalled and no longer fits in the embroidery frame. Rotate the pattern 90 degrees.
16	The safety device has been activated. Is the thread tangled? Is the needle bent?	This message is displayed when a malfunction occurred, such as the thread becoming tangled or the needle is bent. The machine stops when it detects a malfunction. Check that the machine is correctly threaded (page 62) and that the needle is not bent.
17	This file cannot be used.	This message is displayed when the file format is incompatible with this machine. Check the list of compatible file formats. (page 107)
18	This pattern cannot be used since it exceeds the data capacity.	This message is displayed when the pattern being opened exceeds the allowable number of stitches or data capacity, or when too many patterns are being edited.
19	This pattern cannot be used.	This message is displayed when you try to retrieve a pattern that was downloaded for a different machine.
20	This pattern cannot combine.	This message is displayed when a split (large-size) pattern is selected to be combined with another embroidery pattern.
21	Trimming sensor error.	This message is displayed when lint or dust may have accumulated within the moving knife, the fixed knife, the thread retaining plate, and their surrounding areas. Clean them. (page 92)
22	USB media is not loaded. Load USB media.	This message is displayed when you tried to recall or save a pattern while no USB media is loaded. Load USB media.
		This message is displayed when you try to use incompatible USB media. For a list of compatible USB media, visit https://s.brother/cpcb/ .
23	Wiper error	This message is displayed when thread is tangled on the wiper. Remove the tangled thread.
		This message is displayed when lint or dust may have accumulated within the moving knife, the fixed knife, the thread retaining plate, and their surrounding areas. Clean them. (page 92)
		This message is displayed when the thread does not pass through the groove in the thread cutter. Pass the thread through the groove securely.

If the machine does not respond when a key is touched

If nothing happens when a key on the screen is touched (no key can be selected or the keys are misaligned), adjust the touch panel as described below.

- 1 Touch anywhere inside the touch panel, and turn the machine off, then on again.

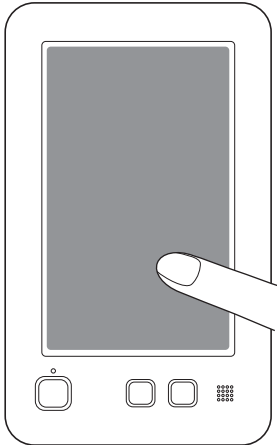

- Continue touching the touch panel until the screen shown below appears.
- The “Start/Stop” button is red.
→ The adjustments screen appears.

- 2 Use the included touch pen to touch the center of the numbered crosses on the screen, in numerical order from 1 to 5.

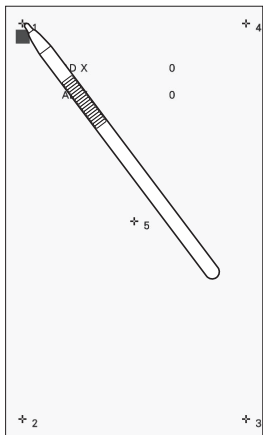

IMPORTANT

- Be sure to use the included touch pen to adjust the touch panel. Do not use a mechanical pencil, screwdriver or any other hard or sharp object. Do not apply pressure to the LCD screen display, otherwise damage to the display may result.

- 3 After making the necessary touch panel adjustment, [OK] will show on the screen.

- If the buzzer sounds when cross number 5 is touched, an error occurred during setting, and [NG] appears on the screen. Carefully touch the crosses again, starting from 1 to 5.

Note

- If the keys still do not respond, even after the touch panel is adjusted, or if the touch panel cannot be adjusted, contact your nearest authorized Brother dealer.

- 4 Turn the machine off, and on again.

SPECIFICATIONS

Machine specifications

Item	Specification		
Dimensions of machine	506 mm (W) × 587 mm (D) × 747 mm (H) (Approx. 20-59/64 inches (W) × 23-7/64 inches (D) × 29-13/32 inches (H)) * When installing this machine, secure a space of at least 35 cm (approx. 13-25/32 inches) from the front of the machine, at least 5 cm (approx. 2 inches) from the rear, and at least 15 cm (approx. 6 inches) from the left and right sides.		
Weight of machine	Approx. 31 kg (Approx. 68 lb)		
Maximum embroidery speed	Max.: 1000 spm Depending on the embroidery frame, maximum stitches in one minute is different.		
Interfaces	USB*1		
Memory	Embroidery patterns	1024 KB or 20 patterns	
Data Types	Embroidery patterns*2	.pes .phc .dst .pen	
Maximum embroidering area	Up to 300 mm (W) × 200 mm (H) (Approx. 11-3/4 inches (W) × 7-7/8 inches (H))		
Types of USB Devices/ Media that can be used*3	Embroidery patterns	Embroidery data can be saved to or recalled from USB media. Use media that meets the following specifications: • USB Flash drive (USB Flash memory) Embroidery data can be recalled only: • USB external CD/DVD drives	
Condition of the [Eco Mode] and [Shutoff Support Mode]	[Eco Mode]	Available time	[OFF], 10 - 120 (minute)
		"Start/Stop" button	Green flashing
		Suspended function	Machine light, Embroidery Crosshair Positioning Laser, Screen display
		After recovering	The machine starts from the previous operation.
	[Shutoff Support Mode]	Available time	[OFF], 1 - 12 (hour)
		"Start/Stop" button	Green slow flashing
		Suspended function	All functions
		After recovering	An error message appears. You need to turn off and on the machine to restart.

*1 Connect the machine and computer (supported operating systems: Microsoft Windows 8.1, Windows 10, Windows 11) using the included USB cable. Do not create folders in "Removable Disk" on a computer.

If embroidery data is stored in a folder in "Removable Disk", that embroidery data cannot be retrieved by the machine.

*2 Using data other than that saved using our data design systems or this machine may cause this machine to malfunction.

When the machine is used to save a file with any extension, it is saved as a .phc data file.

.dst data is displayed in the pattern list screen by file name (the actual image cannot be displayed). The full file name may not be displayed depending on the number of characters in the file name.

Since Tajima (.dst) data does not contain specific thread color information, it is displayed with our default thread color sequence.

Check the preview and change the thread colors as desired.

*3 USB media is commercially available, but some USB media may not be usable with this machine.

Please visit our website <https://s.brother/cpcb/> for more details.

* Depending on the type of USB devices/media being used, either directly plug the USB device into the machine's USB port or plug the USB media Reader/Writer into the machine's USB port.

* Please be aware that some specifications may change without notice.

IMPORTANT

- When using embroidery data other than our original patterns, the thread may break or the needle may break or bend when embroidering with a stitch density that is too fine or when embroidering three or more overlapping stitches. In that case, use one of our original data design systems to edit the embroidery data.

UPDATING YOUR MACHINE'S SOFTWARE

You can update your machine's software using the following two procedures. For update information, refer to the Brother support website <http://s.brother/cucab/>. If an update file is posted, download the file, and then update the machine according to the following procedure.

- Using USB media to update
- Using computer to update

Memo

- The software version of the machine can be checked from the settings screen. (page 21)

Using USB media to update



(page 22):
An instruction video is available for this topic.

- 1 While pressing the automatic needle-threading button, turn the main power on.

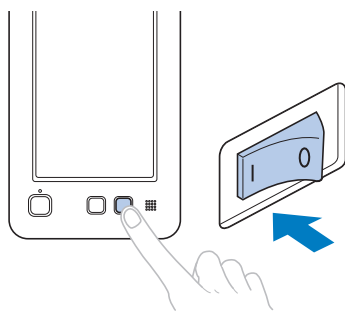

→ The following screen will appear on the LCD.

- 2 Touch .

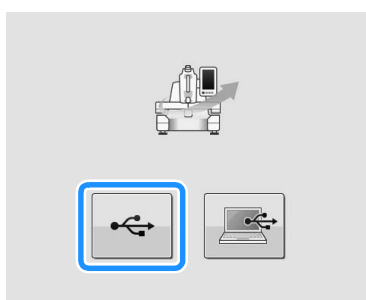

- 3 Insert the USB media where the update file is saved into the machine's USB port.

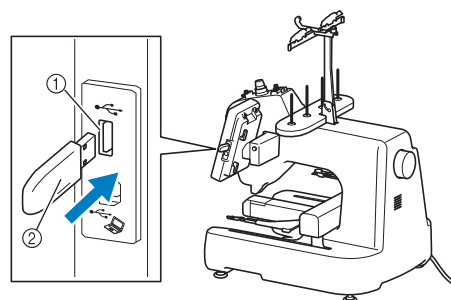

- ① USB port
- ② USB media

Note

- Save only the update file on the USB media.

- 4 Touch  to update the machine.



- Do not turn the machine OFF during the update.
- When the update is performed normally, the completion message will appear.

- 5 Remove the USB media, and turn the machine off and on again.

Using computer to update

For computers and operating systems, refer to "SPECIFICATIONS" on page 107.

Note

- Do not connect any additional USB media devices to your computer when using the USB cable.

- 1 While pressing the automatic needle-threading button, turn the main power on.

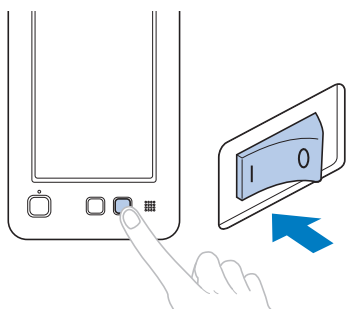

→ The following screen will appear on the LCD.

- 2 Touch .

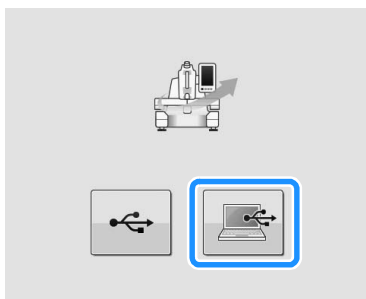

- 3 Plug the USB cable connector into the corresponding USB ports for the computer and for the machine.

- 4 Copy the update file to "Removable Disk" on the computer.

- 5 Touch  to update the machine.

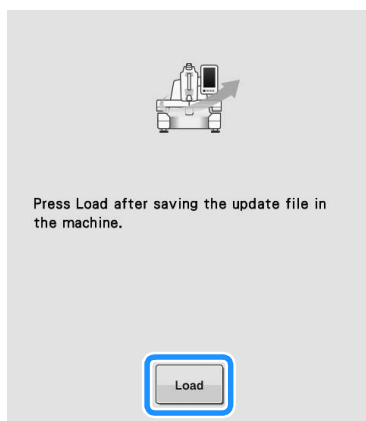

- Do not turn the machine OFF during the update.

→ When the update is performed normally, the completion message will appear.

- 6 Unplug the USB cable, and turn the machine off and on again.

INDEX

Symbols

"DST" setting 59

A

Adjusting
 legs 16
 touch panel 106
 Aligned characters 86
 Appliqué alphabet 34
 Appliqué embroidery 74
 Automatic needle-threading button 14, 65
 Automatic needle-threading mechanism 65
 Automatic thread cutting function 58

B

Basic procedures 23
 Basting 73
 Bobbin case 23, 93
 removing 23
 Border function 38

C

Canton fleece 48
 Canvas 48
 Carriage 13
 Change thread color key 36, 42
 Changing
 basting distance 73
 colors of the pattern 42
 display guides 84
 thread color display 85
 thread density 38
 Checking
 preview image 47
 thread color 61
 Cleaning
 around the needle plate 92
 bobbin case 93
 hook 91
 LCD 91
 machine surface 91
 maintenance message 97
 oiling machine 96
 thread paths 93
 Clock set 19, 20
 Color thread table 42
 Combining patterns 34
 Corduroy 48
 Cotton sheeting 48

D

Delete key 37
 Denim 48
 Density key 37, 38
 Display guides 84
 Distance from center (horizontal) 36
 Distance from center (vertical) 36
 Dress shirt (woven) 48

E

Editing 35
 restart from beginning or middle 70
 Embroidering order 56
 Embroidering screen 56, 61

Embroidering time 56
 Embroidery 67
 aligned characters 86
 small fabric 51
 Embroidery Crosshair Positioning Laser 60, 77
 Embroidery frame
 attaching to the machine 52
 types 53
 Embroidery Frame Holder
 attaching 17
 Embroidery frame indicators 35, 48, 56
 Embroidery key 37
 Embroidery light 13
 Embroidery patterns
 editing 35
 selecting 28
 Embroidery sheet 50
 Embroidery thread 62
 Error messages 104

F

Fabric/stabilizer compatibility chart 48
 Feet 13
 Forward/Backward stitch key 57, 69, 70
 Frame move key 20, 53

G

Going back through the stitching 69, 70
 Golf shirt 48

H

Handwheel 14
 Headwear 48
 Hook 91
 Hook cover/Hook 13
 Hooping 49
 Horizontal mirror image key 37

I

Included accessories 15

J

Jump code 59

L

LCD 14, 20
 Lingerie or silk 48
 Lower thread guide 13

M

Main power switch 14, 18
 Maximum embroidery speed key 57
 Middle thread guide 13

N

Needle
 threading 65
 Number of thread color changes 56

O

Oiling	96
Operation panel	13, 14

P

Pattern display area	29
Pattern editing screen	35
Pattern selection keys	37
Pattern size	35, 56
Positioning keys	37, 57
Power cord receptacle	14
Power supply cord	18
Preview key	37, 57
Previewing the image	47

R

Region display	36, 56
Restart from beginning	70
Resume embroidering	71
Rotate key	36
Rotation angle	36

S

Satin jacket	48
Selecting embroidery pattern	28, 35
Setting up	15
Silk	48
Size (horizontal)	35
Size (vertical)	35
Size key	36
Speaker	14
Specifications	107
Split (large-size) patterns	88
Spool stand	13
Stabilizer	47, 48
Start/Stop button	14, 67
Starting position key	85
Stitch count	56
Stopping embroidering	68
Sweater knit	48
Sweatshirt	48

T

Tajima data	59
Terms of Use	5
Terry cloth	48
Thread	62
Thread color display	85
Thread color sequence display	36, 56
Thread density	38
Thread guide	13, 62
Thread guide assembly	16
Thread mark	40
Thread spools easily changing	66
Thread tension disc	63
Thread tension knob	13, 82
Thread trimming button	14, 68
Thread trimming function	58
Threading bobbin thread	23
needle	65
upper thread	61
Touch pen holder	14
Troubleshooting	98
T-shirt	48

U

Uninterrupted embroidering (one color)	83
Unlock key	57
Updating machine's software	109
computer	110
USB media	109
Upper thread guide pretension knob	82
Upper threading	61, 62
USB port computer connection	87
USB media connection	87

V

Ventilation slots	14
Version	21

Various optional accessories are available to be purchased separately.

Visit our website <https://s.brother/cocab/> .



Please visit us at <https://s.brother/cpcab/> where you can get product support and answers to frequently asked questions (FAQs).



Be sure to install the latest software.

A variety of functional improvements are being performed in the latest version.



Brother SupportCenter is a mobile app that provides the support information for your Brother product.

