



BERNINA Q-matic

Instruction Manual





Dear BERNINA customer

Thank you very much! You have decided on a top-quality accessory for your BERNINA Longarm machine and therefore on a product which will delight you for years. For more than 100 years our family company has attached greatest importance to satisfied customers. As for me, it is a matter of personal concern to offer you Swiss development and precision at the height of perfection, future-orientated sewing technology and a comprehensive customer service.

The BERNINA Longarm machines are ultramodern models whose development not only focused the highest demands on technique and the ease of use but also the development of complex accessories and software. After all we sell our products to creative people like you, who do not only appreciate high quality but who also keep making progress in creativity, adapting artistic competences and increasing your skills with our products.

Enjoy creative Longarm-quilting with the BERNINA Q-matic software and visit us for further information at www.bernina.com. Our highly trained BERNINA dealers will inform you about further service and maintenance offers. I wish you lots of pleasure and creative hours with your BERNINA Longarm and Q-matic.

A handwritten signature in black ink, reading "H.P. Ueltschi". The signature is written in a cursive, flowing style.

H.P. Ueltschi

Owner

BERNINA International AG

CH-8266 Steckborn

Edition notice

Text, Setting and Layout

BERNINA International AG

Fotos

BERNINA International AG

Artikelnummer

2016.08 en 1018305.0.04

Translation of the original instruction manual

1st Edition

Copyright

2016 BERNINA International AG

All rights reserved: For technical reasons and for the purpose of product improvements, changes concerning the features of the machine can be made at any time and without advance notice. The supplied accessory can vary depending on the country of delivery.



Contents

IMPORTANT SAFETY INSTRUCTIONS Software	8
SAVE THESE INSTRUCTIONS	11
IMPORTANT SAFETY INSTRUCTIONS Hardware	11
SAVE THESE INSTRUCTIONS!	18
1 My Q-matic	19
1.1 Introduction.....	19
1.2 Welcome to the world of BERNINA.....	19
1.3 Key to signs.....	20
1.4 Introduction and the operation principle of the BERNINA Q-matic	20
Q-matic system.....	20
Q-matic Software.....	20
Art & Stitch software.....	21
Interactions between the programs Q-matic and Art & Stitch.....	21
Operating principle with the two file types quilt design and quilt project (Q-matic Software).....	21
1.5 Overview system.....	22
Overview front	22
Overview side.....	23
1.6 Overview User interface.....	23
Overview menu bar.....	23
Overview functions and visual display.....	24
Overview Display.....	24
Overview upper Tool Center.....	25
Overview lower Tool Center.....	25
Overview icons.....	26
1.7 Delivery content.....	27
Delivery content Art & Stitch software.....	27
Delivery content Q-matic system.....	27
1.8 Installation and operation of the software and the PC/Monitor.....	27
Internet use with the Q-matic Touch PC.....	27
Replacing the All-in-One Touch PC.....	27
Reinstalling Windows.....	28
Reinstalling or Update of the Art & Stitch Software.....	28
Reinstalling or Update of the Q-matic software/firmware.....	28
Update Q-matic software	28
Update Q-Series firmware	29
Saving quilt designs and tags on a BERNINA USB Stick.....	30
2 Quilting preparation	31
2.1 Connecting and switching on the Frame machine.....	31
2.2 Spool pin.....	31
2.3 Presser foot.....	31
2.4 Needle and stitch plate.....	31
2.5 Threading.....	31

2.6	Calling up help concerning Q 20 / Q 24.....	31
2.7	Q-matic system status and troubleshooting.....	31
2.8	Starting and switching off the Q-matic.....	33
2.9	Pressing the emergency stop knob.....	34
2.10	Restarting the system after a case of emergency.....	34
2.11	Creating the safe area.....	34
3	Settings.....	36
3.1	Activating/Deactivating securing.....	36
3.2	Sewing on/off.....	36
3.3	Grid on/off.....	36
3.4	Signals on/off.....	36
3.5	The needle is centered in the «Editing Display».....	36
3.6	Changing the Easy Glide settings of the machine.....	37
4	Creative quilting.....	38
4.1	Selecting a quilt design.....	38
4.2	Deleting quilt designs from the «Design Center».....	38
4.3	Searching quilt designs.....	39
4.4	Editing quilt designs.....	40
	Calling up the Help.....	40
	Moving quilt designs.....	40
	Copying quilt designs.....	41
	Deleting quilt designs.....	41
	Zooming in the view of the quilt design at the desired position.....	41
	Changing the 1:1 view of the quilt design.....	42
	Adapting the view of the quilt design to the size of the display.....	42
	Zooming the view of the quilt design in or out.....	42
	Entering the size of the quilt top.....	43
	Placing and deleting markers.....	44
	Realigning the safe area in the «Editing Display».....	44
	Realigning the safe area at the reference point.....	45
	Grab and drop.....	46
	Defining the sewing sequence.....	47
	Put quilt patterns in a waiting queue or remove it.....	47
	Changing the sewing direction.....	48
	Rotating quilt designs.....	49
	Mirroring quilt designs.....	50
	Masking quilt designs using «Design».....	51
	Masking quilt designs using «Create Region» via the «Sewhead».....	53
	Masking quilt designs using «Create Region» in the «Editing Display».....	55
	Defining a boundary via the «Sewhead».....	56
	Defining a boundary in the «Editing Display».....	58
	Trimming quilt designs via the «Sewhead».....	60
	Trimming quilt designs in the «Editing Display».....	62
	Duplicating quilt designs (E2E).....	64
	Multiple duplication of quilt designs.....	65
	Connecting quilt designs.....	67



	Separating quilt designs.....	68
	Aligning quilt designs in the «Editing Display».....	68
	Aligning quilt designs via the «Sewhead».....	70
	Altering the size of quilt designs in the «Editing Display».....	71
	Altering the size of quilt designs via the «Sewhead».....	73
	Altering the size of quilt designs via the enter keys.....	74
	Transferring quilt designs to the program Art & Stitch.....	75
4.5	Administrating quilt projects and quilt designs.....	76
	Saving a quilt project.....	76
	Opening a quilt project.....	76
	Creating a new quilt project.....	77
	Saving quilt designs.....	77
	Saving quilt designs on the BERNINA USB stick.....	77
	Importing quilt designs.....	77
	Importing quilt designs from the BERNINA USB stick.....	78
	Deleting quilt designs from the «Design Center».....	79
	Deleting quilt designs from the «Design Pool».....	79
	Deleting quilt projects.....	80
	Creating tags.....	80
	Altering tags.....	81
	Deleting tags.....	81
	Allocating tags to a quilt design.....	82
	Allocating tags to several quilt designs.....	83
	Removing tags from one quilt design.....	83
	Removing tags from several quilt designs.....	84
5	Quilting.....	86
5.1	Sewing quilt designs.....	86
5.2	Interrupting the sewing process of quilt designs.....	86
5.3	Interrupting the sewing process of a quilt design after a thread breakage.....	87
6	Attachment.....	88
6.1	Cleaning the display.....	88
6.2	Cleaning the energy chain and the X-Y-belts.....	88
6.3	Troubleshooting.....	89
6.4	Error messages Q-matic software.....	90
6.5	Overview quilt designs.....	91
	Tips around the quilt designs.....	91
	Amanda Murphy.....	91
	Keryn Emmerson.....	94
	Patricia Ritter.....	96
	Aggy Burczyk.....	98
	Basic Shapes by AB.....	100
	Alfonsina Uriburu.....	102
	Linzi Upton.....	104
	Gerda Raschle.....	105
	Lisa Calle.....	106
	Index.....	107

IMPORTANT SAFETY INSTRUCTIONS

Software

Not any part of the publication or the enclosed software may be copied or spread, transferred, converted, saved in a database, translated to a human or a computer language or made accessible to a third party in any form or in any way, neither electronically nor mechanically nor manually or in any other way.

NOTE

The illustrated screen pictures of the software, which are showed in this manual, serve the purpose to visualize and can differ from the ones which really appear in the software.

PRINTED INSTRUCTION MANUAL

Registered owners of the BERNINA Q-matic software are allowed to copy the BERNINA Q-matic instruction manual for the personal use once (1). This copy can be printed by a private printer or by a commercial printing office.

LIMITED WARRANTY

BERNINA International AG warrants for 90 days, starting on the day when the software has been transferred to you that product is free of any defects in workmanship and materials. You are given the possibility to return the products which are covered by this warranty along with the proof of having purchased them to BERNINA or to the specialised BERNINA dealer during this particular warranty duration. You will get replacement free of cost. Any other costs such as cost of shipment or insurance shall be those of the purchaser. The risk of lost, damage or loss of the products is the purchaser's alone. The purchaser relies on his personal knowledge and on his own judgement when choosing the software which is only needed for private use. The purchaser assumes the complete risk concerning the results and the performance of the software. Subject to legally determined warranties and conditions BERNINA International AG

declines any acceptance of all other warranties and conditions, be it explicit or implicit, unconditionally and without restriction any warranties and conditions concerning the general useability, the suitability for a certain purpose, property rights and the invasion of third-party rights. Particularly BERNINA International AG doesn't provide the guarantee that the software meets the purchaser's requirements, runs flawlessly or appears exactly as this is shown in the accompanying documentation.

LIMITED LIABILITY

As far as legally tolerable, neither BERNINA International AG, their developers, the people in power, the employees nor subcompanies are responsible to you for consequential, incidental or indirect damages (compensation for losses in sale, operational interruptions, loss of data etc.), whether predictable or not, which emerge from the use or the non-usability of the software or the provided safety device and cable as well as the instruction manual, independent on the basis for a claim and also when BERNINA or an authorized BERNINA retailer has been informed about the eventuality of such damages. Some states or jurisdictions don't allow the exclusion of incidental or consequential, indirect or particular damages, which means that the before mentioned limited liability may not apply for you.

CONCLUSION

Your license to use the BERNINA Q-matic software is legally valid as long as you stick to the terms of the license agreement. If you do not stick to even one term of the license agreement, the immediate annulment of the license agreement will follow automatically without any announcing notice by BERNINA International AG. You can conclude the license at any time by returning the BERNINA Q-matic

software plus any copies of it, the backup device and the cable as well as the complete accompanying documentation to BERNINA International AG.

Application of the anti-virus software and other programs:

On the All-in-one Touch PC which is supplied with the Q-matic, basically no other programs than the ones included in the delivery content should be installed. Only access the Internet when this is explicitly required by the customer service/support provided by BERNINA or Art & Stitch in connection with the technical support. Explicitly no other anti-virus software than the program «Windows Defender» which is already installed in Windows 10 is to be used. This



is the only way to ensure that the Q-matic system runs flawlessly. Always use your personal laptop or PC to surf the World wide web when purchasing new designs or to run another software.

License agreements of the Q-matic software and the Art & Stitch Software

By installing and using the Q-matic software and Art & Stitch software, the general terms of the license agreements are accepted automatically by the user.

SAVE THESE INSTRUCTIONS

Appropriate use

Your BERNINA®-Q-matic software has been developed and designed for private household use. It's purpose is to quilt fabrics and other materials as it is described in this instruction manual. Any other use is not considered appropriate. BERNINA assumes no liability concerning consequences resulting from an inappropriate usage.

IMPORTANT SAFETY INSTRUCTIONS

Hardware

Please be aware of the following basic safety instructions when using your machine. Before using this machine, read instruction manual carefully.

DANGER!

To reduce the risk of electrical shock:

- Never leave the machine unattended as long as it is plugged in.

- Always unplug the machine from the electrical outlet immediately after using and before cleaning.

Protection against LED radiation:

- Do not view the LED light directly with optical instruments (e.g. magnifier). The LED light corresponds with protection class 1M.

WARNING

To reduce the risk of burns, fire, electric shock or injury to persons:

- To assemble the system at least 2 adult people are needed.
- The installation, the operation and the repairs are only to be carried out by people who have sufficient knowledge of the system and this instruction. In addition to that, these people must know any warnings and precautions which are indicated in the safety notes. Furthermore these people need to possess the education, instructions and the authorization to connect and disconnect circuits and devices according to the existing safety regulations.
- Before you start installing and operating the system, please check all the components for any transport or installation damages. Don't try to disassemble the system or system components. Contact the authorized BERNINA dealer if components need to be repaired or replaced.
- Never lift the system holding the motor cables, power cables or hydraulic tubes. Keep the motor cables, power cables and the hydraulic tubes away from heat, sharp edges and wetness. Stop operating the product immediately when you notice that motor cables, power cables or hydraulic tubes are damaged and replace the damaged components at once. Do never carry out any repairs on motor cables, power cables or hydraulic tubes.



- Don't operate the system outdoor. Don't expose the system to damp or wet conditions. Avoid surroundings with chemical influences or corrosive environment. Don't operate the system near inflammable dissolvents, propellants and/or explosive substances (e.g. gas, steam, dust etc.). Avoid temperatures beyond the acceptable temperature range from 5° to 45°C. Don't expose the components of the system to vibrations and/or impact loads.
- Don't insert any objects into the system when it is connected to the power supply.
- Be careful when laying the extension cables. Make sure that the cables are not pinched or taut. Position the cable so that tripping can be avoided. Only use spare parts and accessory parts which are authorized or provided by BERNINA.
- To disconnect, turn the main power switch at the control cabinet to «0» then remove the plug from the outlet. Do not unplug by pulling the cord, instead grasp the plug to pull it from the outlet.
- Always disconnect the power plug from the electrical outlet before cleaning and maintenance adjustments, which are mentioned in the instruction manual, are carried out.
- Clean the system components with a mild detergent and a damp cloth. Don't use corrosive detergent or high pressure wash systems to clean the components. Make sure that the system is clean and dry before you connect it to the power supply and start operating it again.
- Use this system only for purposes as described in this manual.

Possible risks

- Never let children be unattended in the surrounding of the system when it is working autonomically.

- Do not use the system as a toy. Close attention is necessary when this Q-matic system is used by or near children.
- Children are not allowed to play with the system.
- While assembling the single and small parts, be careful that they are out of the reach of children (choking hazard)!
- **Choking hazard!** Keep plastic bags away from children and babies. Don't pull the bags over the head.
- Cleaning and maintenance work must not be carried out by children unless they are supervised.
- Standing/Sitting on the frame is strictly forbidden. Inappropriate use of the system can result in serious injuries.
- Make sure that you don't pinch your fingers during the assembly.
- Never operate this system if it has a damaged cord or plug or if it is not working properly. Contact the nearest authorized BERNINA dealer for further assistance.

General warnings

- With the Q-matic installation, the channel locks (Optional accessory) must not be attached to the system anymore. Otherwise it can result in bruises.
- With the Q-matic installation, the magnetic park positioning brackets with a magnet at the carriage must be removed and replaced by the new Q-matic stand-off.
- Staying within (between the fabric rails and the table) or beneath the quilt frame is strictly forbidden during the automatic operation.
- Only proven service technicians are allowed to open the control cabinet. Inside the control cabinet current-carrying parts are accessible. **Danger!**

- Side clamps can become unfastened from the fabric. Children (or short people) shouldn't stand on the side where the side clamps could be catapulted to.
- Switching off the system must be carried out via the main switch and not via the emergency stop knob. The emergency stop knob is considered to be used only in emergency situations.
- When the PC is supplied via the control cabinet, it must be shut down via the regular operating system prior to switching off the Q-matic system. Otherwise damages to the software resp. the operating system or the loss of data can occur.
- Never plug in or out any cables when the system is switched on.

For all grounded, cord-connected appliances

- **GROUNDING INSTRUCTIONS:** This appliance must be grounded. In the event of malfunction or breakdown, grounding provides a path of least resistance for electric current to reduce the risk of electric shock. This appliance is equipped with a cord having an equipment-grounding conductor and a grounding plug. The plug must be plugged into an appropriate outlet that is properly installed and grounded in accordance with all local safety regulations.
- **DANGER** Improper connection of the equipment-grounding conductor can result in a risk of electric shock. The conductor with insulation having an outer surface that is green with or without yellow stripes is the equipment-grounding conductor. If repair or replacement of the cord or plug is necessary, do not connect the equipment-grounding conductor to a live terminal. Check with a qualified electrician or serviceman if the grounding instructions are not completely understood, or if in doubt as to whether the appliance is properly grounded. Do not modify the plug provided with the appliance – if it will not fit the outlet, have a proper outlet installed by a qualified electrician.

Notes on assembly instruction

- To connect the cabling to the motor drives their casings must be opened. Therefore a contact with sensitive electronic components is possible. As a consequence it is necessary to be grounded before mounting the cables to the motor drives so that any



electrostatic charge can be discharged. This can be done by touching an exposed metal part of the existing quilt frame beforehand.

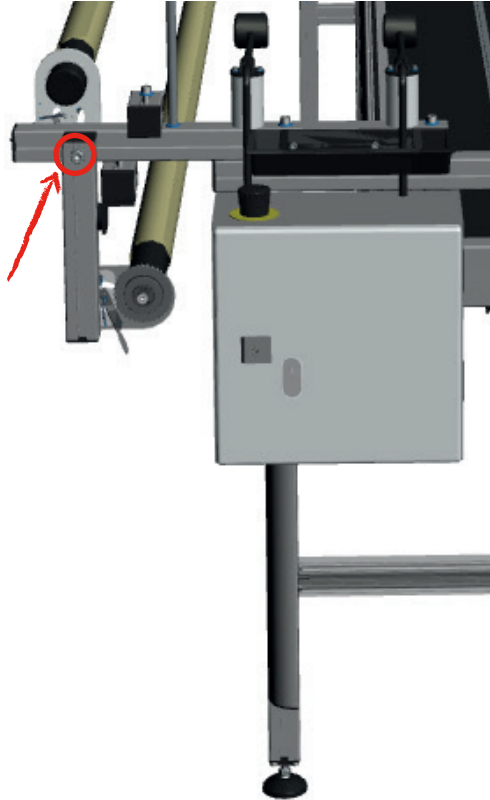

Extending the Frame



The Frame isn't provided with extended legs

The Frame is likely to topple.

> Purchase and attach the appropriate upgrade kit at the specialized BERNINA dealer's.

⇒ The Frame must be equipped with extended legs. **If this is not the case, the Q-matic system must not be assembled on any terms.**

Make sure that the Frame is equipped with extended legs before the Q-matic-System is assembled. If this is not the case, purchase the appropriate upgrade kit at the specialized BERNINA dealer and attach it to the Frame.

Frame **without** extended legs:

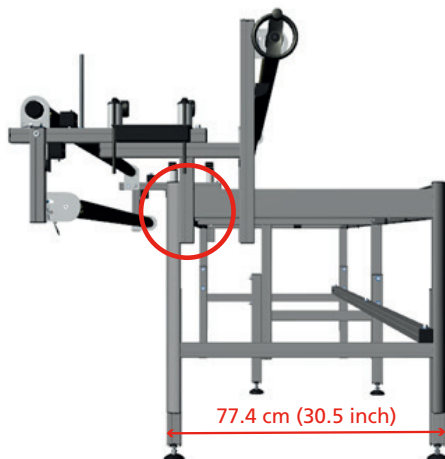

Frame **with** extended legs:

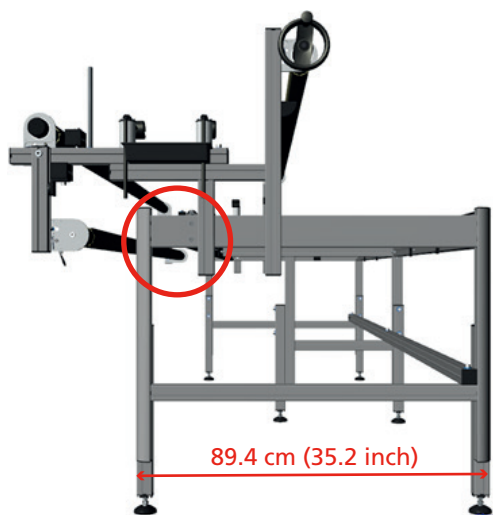

SAVE THESE INSTRUCTIONS!

Appropriate use

Your BERNINA machine with Frame is built and designed for ambitious hobby practice. It answers the purpose of quilting fabrics as described in the separate instruction manual of BERNINA Q 20 / Q 24. Any other usage is not intended. BERNINA doesn't assume liability resulting from inappropriate application.



1 My Q-matic

1.1 Introduction

On the machines Q 20 / Q24 large quilt projects can be created. All your personal settings can be saved and recalled at any time.

The Q-matic program supports you when quilting and provides more than 230 quilt designs (Q-matic system) and 350 quilt designs (Art & Stitch).

In addition to this instruction manual, the machine offers a help program which provides useful support and helpful details concerning some functions of the Q-matic system.

The **Help program** contains information on particular functions and applications in the user interface.

Further Information

In addition to this instruction manual, further information products are enclosed in your Q-matic.

The current version of your instruction manual as well as a lot of further information on the machine and accessories can be found on our website at <http://www.bernina.com>

1.2 Welcome to the world of BERNINA

Made to create, this is the slogan of BERNINA. Not only our machines do support you to implement your ideas, but on top of that, our below mentioned opportunities also offer various inspirations and instructions for your future projects as well as the option to exchange ideas with other sewing, quilting and embroidering enthusiasts. We wish you lots of pleasure doing that.

inspiration – the sewing magazine

Are you looking for ideas and instructions for great projects? In that case the BERNINA magazine «inspiration» is exactly what you need. «inspiration» offers extraordinary sewing and embroidery ideas four times a year. From seasonal fashion trends to trendy accessories and practical tips to decorate your home in an original way.

<http://www.bernina.com/inspiration>

The magazine is available in the languages English, German, Dutch and French. Not available in all countries.

BERNINA Blog

Fancy instructions, free sewing patterns and embroidery motifs as well as many new ideas: all this you can find in the weekly blog by BERNINA. Our experts give valuable tips and explain step by step how you can achieve the desired result. In the community you can upload your own projects and exchange experiences and ideas with other sewing and embroidering enthusiasts.

<http://www.bernina.com/blog>

Provided in the languages English, German and Dutch.

BERNINA YouTube Channel

On YouTube we offer a wide range of how-to videos and support concerning the most important functions of our machines. Detailed explanations are also provided as for the various presser feet, so that your projects will succeed completely.

<http://www.youtube.com/BerninaInternational>

Provided in the languages English and German.

BERNINA Social Media

Follow us on the social networking to learn more about events, thrilling projects as well as tips and tricks all about sewing and embroidering. We will keep you informed and we are looking forward to presenting you the one or the other highlight from the world of BERNINA.

<http://www.bernina.com/social-media>

1.3 Key to signs



Labels a danger with a high risk which can lead to severe injury or even to death unless it is avoided.



Labels a danger with a medium risk which can lead to severe injury unless it is avoided.



Labels a danger with a low risk which can lead to light or medium injury unless it is avoided.



Labels a danger which can end up with damage unless it is avoided.



Tips provided by BERNINA **Quilt experts** can be found next to this sign.

By means of illustration, sample pictures are used in this instruction manual. The machines as well as the accessory shown in the pictures may vary from the delivery content of your machine.

1.4 Introduction and the operation principle of the BERNINA Q-matic

Q-matic system

The Q-matic system is a comprehensive, contemporary and automated Longarm system which has been designed to create quilt projects in a computerized way. The system consists of various mechanic components, electronic, the All-in-One touch PC as well as the software programs Q-matic and Art & Stitch.

Q-matic Software

By means of the Q-matic software, you can design a quilt project easily and intuitively. At first you should define the Safe Area, so that the section which is to be quilted has been determined. The function EasyGlide supports the movements of the machine. Afterwards you enter the size of your quilt so that the editing area matches exactly with the size of your quilt. Now you are ready to start your quilt project.

You can choose from more than 230 quilt designs mustern in the Design Pool and for a better overview you copy them into the Design Center where they are directly available during the creative process. You can edit quilt designs easily by mirroring, enlarging, rotating, trimming, combining or masking. Afterwards the quilt designs can be positioned perfectly on the quilt top by the help of Boundary, Markers or Grab/Drop. Using the function Align, quilt designs can be also aligned along a line.

You can create a Pantograph in a few steps by choosing the function E2E more or Multiply. To improve the view of the editing area, various zooming functions are provided.

As soon as you are satisfied with your quilt project, you can start sewing. In doing so you can determine in which sequence the quilt designs are to be sewn. You can also remove quilt designs from the waiting line if you don't intend to sew them at the moment. After you have sewn the first rows of a Pantograph and you need to roll the quilt, then the function Realign Safe Area is on hand to join the following rows seamlessly to

the already sewn ones. You can pause the sewing process on the Sewhead at any time to adjust the stitch length or the thread tension. After a thread breakage the machine stops and with the help of the quilt sequence control function the quilt process can be resumed seamlessly at the position of the breakage.

Quilt designs and quilt projects can be saved and called up at any time. This means that all your personally designed creations are always available.

Art & Stitch software

The Art & Stitch software provides a very comprehensive digitalization program. This software enables you to create your own quilt designs. Using Art & Stitch, files and designs consisting of various Longarm formats and vector graphics can be opened. You also have the option to digitize a quilt design based on a picture, to create an applique design easily or to design creative filling patterns as a background. Moreover you can edit an already existing quilt design so that it meets your expectations.

Afterwards you can save the quilt designs in any common Longarm format. Moreover, Art & Stitch provides more than 350 quilt designs so you can let your creativity run free.

Interactions between the programs Q-matic and Art & Stitch

You have the option to switch from the Q-matic software to the Art & Stitch Software at the touch of a button. In doing so, the previously selected quilt design is directly transferred to the Art & Stitch and can be edited in detail. Subsequently the edited quilt design can be transferred at the touch of a button back to the Q-matic interface to be quilted. At the same time the quilt design is saved in two formats (.ans und .bqm). This allows you to import the edited quilt design into the Q-matic software at a later time, to upload it to the Design Pool and to edit it further on.

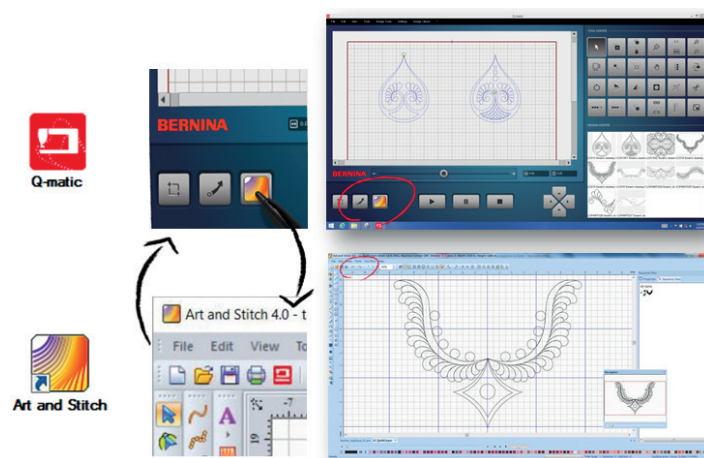

Operating principle with the two file types quilt design and quilt project (Q-matic Software)

A quilt design consists of one single quilt design or several joined and grouped quilt designs which form one unit. The quilt design can be edited and altered as a unit. To save a quilt design it must be selected and can then be saved under any name. The quilt design is saved automatically in the format *.bqm and filed in the folder «Designs» on the desktop. It can also be saved at any other location, for example in the folder «Personal files» or on a BERNINA USB stick.

A quilt project consists of several quilt designs which have been edited individually or together but which have not been necessarily grouped. Moreover a quilt project involves information concerning the quilt size and the aligning of the different quilt designs on the quilt. In short, the complete project. Quilt projects can also be saved. The project is saved on the desktop in the format *.bqp in the folder «Projects». The projects can also be saved at any other location. Saved quilt projects can be opened and edited further on at any time.

Quilt designs can be imported into the Q-matic software directly in the formats *.bqm and *.dxf.

The following illustration shows individual quilt designs (red). By placing designs on the quilt (beige) a whole quilt project is produced.

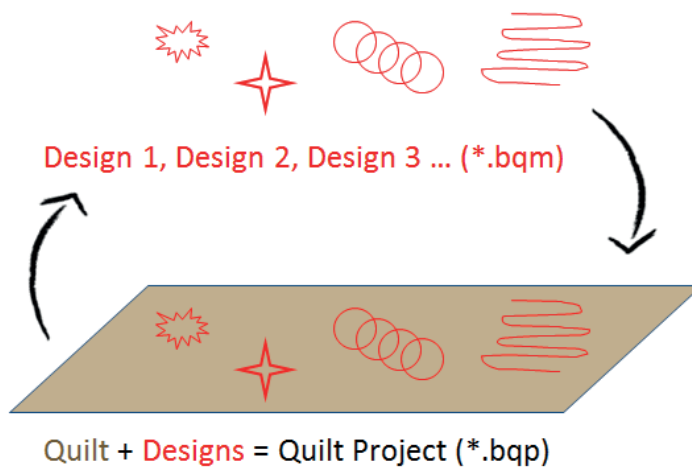

1.5 Overview system

Overview front

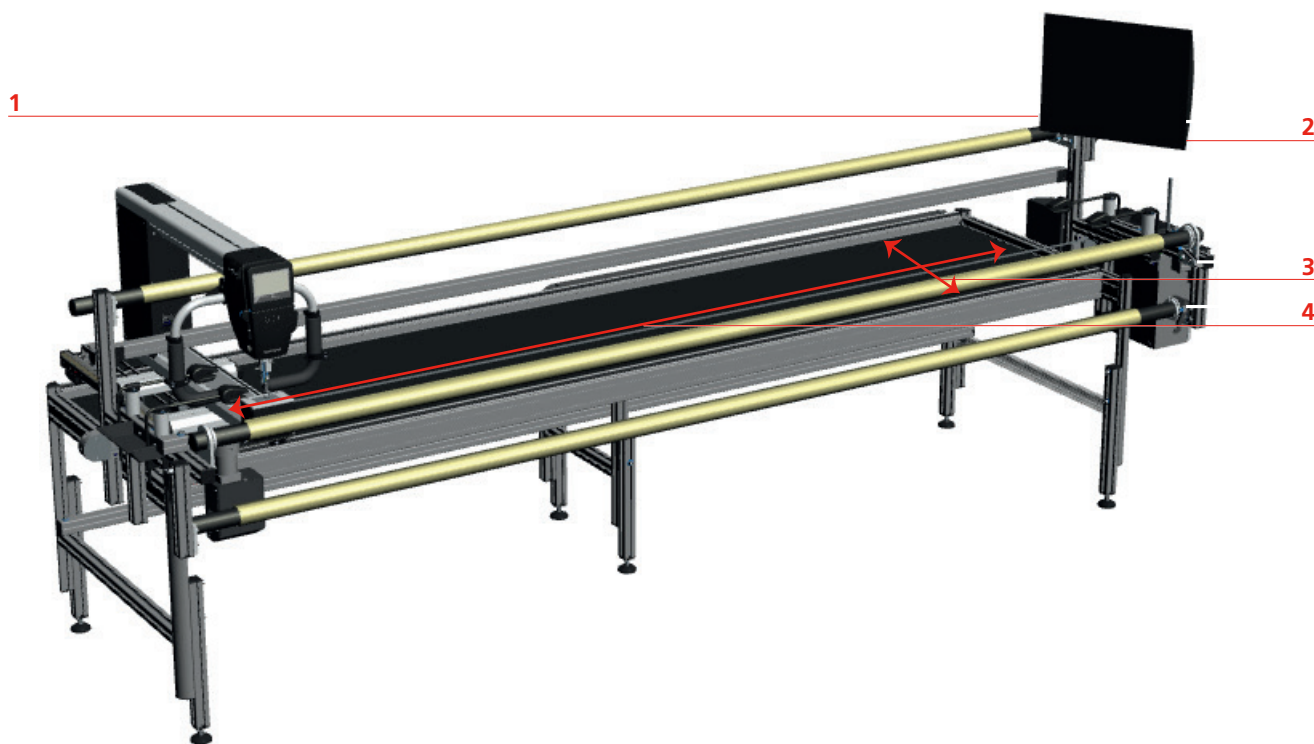

- 1 USB ports
- 3 Y-Drive

- 2 Switching on the PC/Monitor
- 4 X-Drive

Overview side



- 1 Emergency stop knob red
2 Start button green

- 3 Power switch

1.6 Overview User interface

Overview menu bar

The menu bar provides the dropdown menu with the functions. Some functions are also available in the «Tool Center». All functions of the menu bar are explained in detail in the instruction manual.

File Edit View Tools Design Tools Settings Design Library ?

- File
- Edit
- View
- Tools
- Design Tools
- Settings
- Design Librara
- ? (Help)

Overview functions and visual display

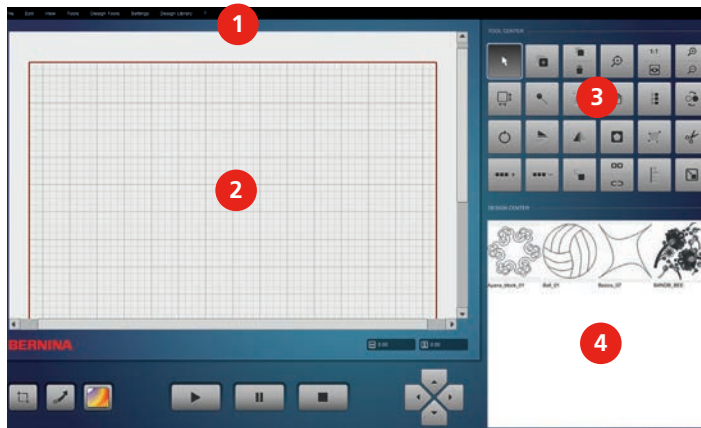

- | | | | |
|---|-----------------|---|---------------|
| 1 | Menu bar | 3 | Tool Center |
| 2 | Editing Display | 4 | Design Center |

Overview Display

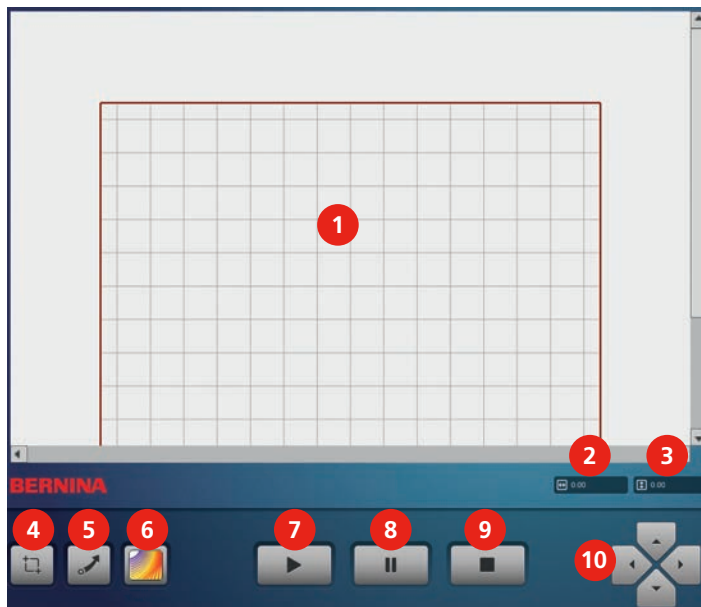

- | | | | |
|---|---------------------------------|----|-----------------|
| 1 | Editing Display | 7 | Start |
| 2 | Width (Width of quilt design) | 8 | Break (Timeout) |
| 3 | Height (Height of quilt design) | 9 | Stop |
| 4 | Safe Area | 10 | Move |
| 5 | Easy Glide | | |
| 6 | Art & Stitch | | |

Overview upper Tool Center







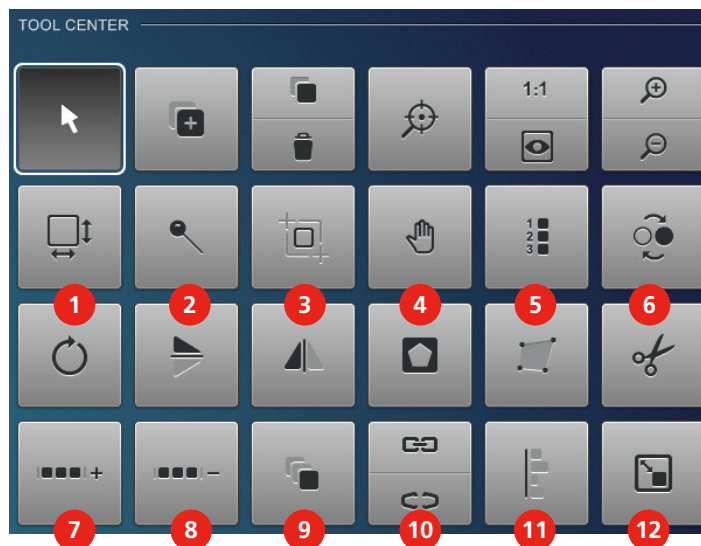





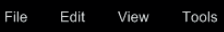

- | | | | |
|---|------------------------------------|----|---|
| 1 | Select | 7 | Quilt Size (Size of quilt design) |
| 2 | Add Design (Adding a quilt design) | 8 | Markers (Marker points) |
| 3 | Copy/Delete | 9 | Realign Safe Area |
| 4 | Center Zoom | 10 | Grab/Drop |
| 5 | Actual Size (1:1)/Full View | 11 | Sew Options (Sequence of sewing) |
| 6 | Zoom In/Zoom Out | 12 | Reverse Sew (Changing the sewing direction) |

Overview lower Tool Center



- | | | | |
|---|----------------------------------|----|-----------------------------|
| 1 | Rotate | 7 | E2E More (Edge to edge +) |
| 2 | Flip (Mirror-image up/down) | 8 | E2E Less (Edge to edge -) |
| 3 | Mirror (Mirror-image left/right) | 9 | Multiply |
| 4 | Mask | 10 | Connect/Unconnect |
| 5 | Boundary | 11 | Align |
| 6 | Trim | 12 | Resize (Adjusting the size) |

Overview icons

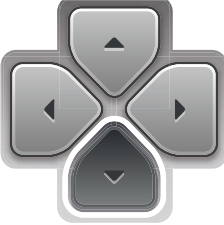
Icon	Name	Purpose
	Menu bar	The menu bar provides the dropdown menu with the functions. Some functions are also available in the «Tool Center».
	Close	The screen is closed and any adjustments are not saved.
	Confirm	Confirms any adjusted settings. The screen is closed.
 	Cancel	The process is canceled. The screen is closed and the previously made adjustments are not saved.
 	Icons «-/+»	Touching the icons «-» and «+» the setting values are changed.
	C	All numbers are deleted in the numerical entry.
	«	The last number is deleted in the numerical entry.
	OK	The screen is closed and the previously made adjustments are saved.
	CLR	The process is canceled. The screen is closed and the previously made adjustments are not saved.
	Preview	A preview is displayed.
	Move	The quilt design can be moved stepwise in the «Editing Display», every step is equal to one pixel. The quilt design can be moved to any direction.

1.7 Delivery content

Delivery content Art & Stitch software

The delivery content of the program Art & Stitch consists of the following parts: CD cover, quick start guide and CD.

Two licenses of the program are offered. The «Art & Stitch Software» is installed on the supplied PC/Monitor. For larger projects it is easier and more comfortable to carry out the work on another computer. Therefore the second license has been provided.

On their website, <http://artandstitch.com>, Art & Stitch provides two instruction manuals (HowToActivate/Deactivate and UserGuide) as well as further information.

The instruction manuals can also be found in the Help menu of Art & Stitch.

Delivery content Q-matic system

The Q-matic software is also installed on the the supplied PC.

1.8 Installation and operation of the software and the PC/Monitor

After having concluded the assembly according to the «Q-matic Assembly Manual», chapter «Initial startup operation», the Q-matic system is completely installed and ready for operation. This means that the software programs can be started and worked with. Hereinafter useful information is given how the Q-matic system is provided with the latest software and firmware updates.

Internet use with the Q-matic Touch PC

NOTICE

Use of the Internet

Only access the internet if this is particularly demanded by the customer service/support by BERNINA or Art & Stitch in the context of technical support.

Only a simple virus protection program is installed on the PC (Standard delivery Windows 10), therefore viruses are likely to get access and could do harm.

- > Explicitly no other virus protection software is to be used than the already installed program «Windows Defender» of Windows 10.
- > Only by this it can be guaranteed that the Q-matic system runs properly.
- > Therefore always use your personal laptop or PC to surf the World Wide Web if you would like to buy other designs or run another software.

The Internet is only to be used for diagnostic reasons of technical support, because only a simple virus protection program is installed on the PC/Monitor:

<http://windows.microsoft.com/de-ch/windows-10/getstarted-protect-your-pc>

Replacing the All-in-One Touch PC

If the PC doesn't work anymore, please contact your specialized BERNINA dealer. We recommend you in case of a new purchase (out of the warranty duration) to buy it at the specialized BERNINA dealer. This includes the advantage that all the programs which are needed for the Q-matic system are installed on the PC.

Therefore the compatibility with the complete Q-matic system can be ensured. This means that you will only have to attach and connect the new PC and can continue quilting.

Reinstalling Windows

If you have to reinstall the Microsoft program for any reason, please find further information at:
<http://windows.microsoft.com/en-us/windows-10/windows-10-recovery-options>

Reinstalling or Update of the Art & Stitch Software

Always save your personal data as for programs, designs and projects, before you reinstall or update the software!

You can find more information and software updates at: <http://artandstitch.com>

Please note: The existing licence code of the present version is usually taken over automatically.

Reinstalling or Update of the Q-matic software/firmware

Always save your personal data as for programs, designs and projects, before you reinstall or update the software!

You can find more information and software updates at: www.bernina.com/longarm

When the Q-matic system is provided with the new software/firmware, make sure that always the latest versions of all components are installed. There are three different updates, which must be compatible with each other:

1. Q-matic software (user interface on the Win 10 touch PC)
2. Q-matic firmware (controlling unit in the control cabinet)
3. Q-Serie firmware (Q 20 resp. Q 24 machine)

Update Q-matic software

Hereinafter the update for the Q-matic software is explained in detail. After the accomplished update of the Q-matic software, the details concerning the update of the Q-matic firmware can be found on the desktop of the touch PC in the folder «Q-matic Software-Firmware» as PDF. Always install the latest Q-matic firmware after having updated Q-matic software. Only by doing this, the proper and accurate interaction of software and firmware can be ensured.

- > In the menu bar of the Q-matic software, touch «? → About».
 - A screen is opened where the presently installed version number of the Q-matic software is displayed.
- > Keep the number of the software version number in your mind resp. write it down.
- > Visit the internet page www.bernina.com/longarm on another computer.
- > Under BERNINA Q-matic, click on the respective icon resp. the link.
- > Check the two software version numbers against each other (installation on the PC and available version online). If on the homepage an updated version is available, carry on in the following way:
- > Download the software.
- > Insert the BERNINA USB stick into the computer.
- > Copy the firmware to the BERNINA USB stick.
- > Close the Q-matic software on the PC/Monitor if this is still open.
- > Start the setup from the BERNINA USB-Stick by touching the icon of the installation program twice in close succession.
- > Follow the instructions on the display.
- > Start the Q-matic software and check whether the latest version has been installed under «About».

Please note: Basically, no user data (designs, projects) is overwritten and all program settings are preserved.

Please note: After the update of the Q-matic software, the latest Q-matic firmware is also to be installed. Only by doing this, the proper and accurate interaction of software and firmware can be ensured! After the accomplished update of the Q-matic software, the details concerning the update of the Q-matic firmware can be found on the desktop of the touch PC in the folder «Q-matic Software-Firmware».

Update Q-Series firmware

The update of the Q 20 / Q 24 firmware can contain relevant adaptations for Q-matic but can also provide mere updates Q 20 / Q 24. Therefore it is recommended to also install the latest Q-Series firmware.

NOTICE

BERNINA USB stick (optional accessory) has been removed too early

The software has not been updated and the machine cannot be used.

- > Remove the BERNINA USB stick (optional accessory) only after the update has been completed successfully.

The current software can be downloaded from www.bernina.com/longarm. As a rule, personal data and settings are taken over automatically during a software update. For safety reasons it is recommended to save data and settings on a BERNINA USB stick before the software update is carried out. If personal data and settings should get lost during a software update, they can be transferred to the machine again afterwards.

- > Insert the BERNINA USB stick with the latest software version into the computer.



- > Touch the icon «Home».

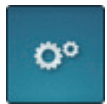

- > Touch the icon «Setup-Program».



- > Touch the icon «Machine settings».



- > Touch the icon «Maintenance/Update».



- > Touch the icon «Updating the machine».



- > Touch the icon «Saving date on the USB stick» to start the saving process.



- > Touch the icon «Update» to start the update process.

Saving quilt designs and tags on a BERNINA USB Stick

The data base of the tags and the imported quilt designs should be saved on a BERNINA USB Stick regularly. If it should be necessary to reinstall the Q-matic software, the data base of the tags and quilt designs can be replaced by this backup.

Prerequisite:

- The BERNINA USB stick must be inserted in the PC/Monitor.
- > Enter/Copy following path to the PC/Monitor: %localappdata%\Bernina
- > Confirm by pressing «Enter».
- > Drag the folder «Q-matic» to the BERNINA USB stick.



2 Quilting preparation

2.1 Connecting and switching on the Frame machine

The BERNINA Q 20 / Q 24 with the Frame and the Q-matic is switched on via the main switch.

2.2 Spool pin

Further information can be found in the instruction of «BERNINA Q 20 / Q 24».

2.3 Presser foot

Further information can be found in the instruction of «BERNINA Q 20 / Q 24».

2.4 Needle and stitch plate

Further information can be found in the instruction of «BERNINA Q 20 / Q 24».

2.5 Threading

Further information can be found in the instruction of «BERNINA Q 20 / Q 24».

2.6 Calling up help concerning Q 20 / Q 24

Further information can be found in the instruction of «BERNINA Q 20 / Q 24».

2.7 Q-matic system status and troubleshooting

At the control cabinet as well as at the two X-Y-drives, two little transparent spy windows are mounted which allow a view of the inner components. When the Q-matic system is started, various LEDs light up resp. flash for a short time. After a few seconds, only one green LED per component should light up continuously under normal conditions. If other LEDs are on or keep flashing after the starting process, a problem must have occurred. In this case, shut the system down completely, disconnect it entirely from the power supply and restart the system. If the problem couldn't be solved after the second attempt, check whether or not the USB cable is plugged in the socket of the PC correctly or the power cable is connected correctly at the back of the Q-machine. If these actions don't help, please turn to your BERNINA partner resp. the technical support.

The Q-matic system provides following status LEDs:

LEDs at the control cabinet: Yellow, green, red (top down).



LEDs at the motor/drive of the Y-axis: green, red. Similar to LEDs at the motor/drive at the X-axis (not shown).



2.8 Starting and switching off the Q-matic



Don't interfere with the running system!

Can lead to severe injuries in the worst case.

- > Never interfere with the running Q-matic system (computer-controlled operation). Only the touch screen at the front of the machine head of the Q 20 / Q 24 and the touch screen of the PC as well as the red emergency stop knob may be used to operate the system. No other parts of the Frame, the Q 20 / Q 24 or the Q-matic system is to be touched during the computer-controlled operation.

- > Switch on the main switch at the control cabinet (1).



- > Turn the red emergency stop knob (3) in arrow direction to unlock it.
- > Keep the green start button (2) pressed for 3 seconds until a click sound can be heard.



- > On the right of the PC/Monitor press the lowest button to switch on the PC/Monitor.
- > Touch the «Q-matic» icon on the display with your finger twice in close succession to start the Q-matic software.
- > If the machine Q 20 / Q 24 hasn't been switched on yet, please find further information in the instruction «Q 20 / Q 24».
 - Now you can work with the Q-matic software.

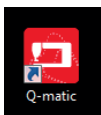

- > In the display top right touch the icon «Close» to finish the program.
- > On the right of the PC/Monitor press the lowest button to switch the PC/Monitor off.
- > Switch off the main switch at the control cabinet.

2.9 Pressing the emergency stop knob



Danger of any kind

Can lead to severe injuries in the worst case.

- > Press the red emergency stop knob to stop the power supply immediately.

Only press the emergency stop knob in case of emergency!

- > Press the red emergency stop knob at the top of the control cabinet.

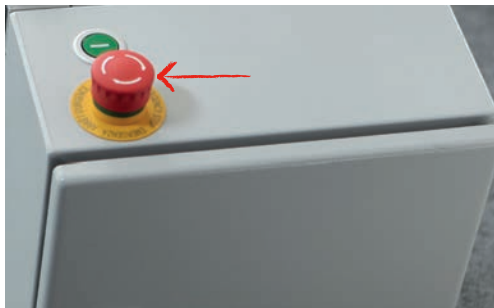

2.10 Restarting the system after a case of emergency

NOTICE

The PC/Monitor is connected with the main switch of the Q-matic

When restarting after an emergency interruption, the PC/Monitor cannot boot directly.

- > The restart of the PC/Monitor takes more time than it usually does.
- > Turn the red emergency stop knob in arrow direction so that the knob is unlocked for the next emergency.

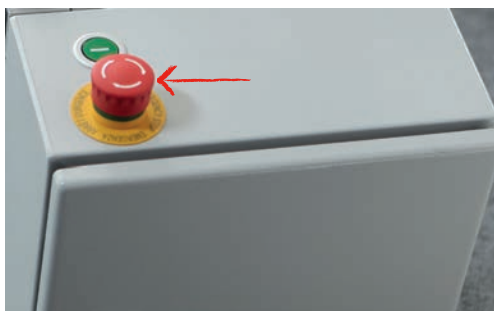

- The power supply is reactivated.

- > Restart the system (see page 33).

2.11 Creating the safe area

This function enables you to determine the quiltable area. With each restart of the Q-matic program, the screen to enter the «Safe Area» appears automatically

- > Place the sewhead/needle in the upper left position (1).
- > Touch the icon (3) or any other handle button (see Manual Q 20 / Q 24) to confirm the positioning.
- > Place the sewhead/needle in the bottom right position (2).

> Touch the icon (4) or any other handle button to confirm the positioning.



– The screen is closed automatically and the previously made adjustments are saved. The «Safe Area» appears in the «Editing Display». If the «Safe Area» does **not** meet your wishes, carry out the next step.



> Touch the icon «Safe Area» or

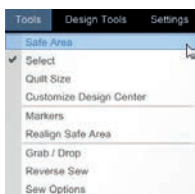

> touch the icon «Tools —> Safe Area» in the menu bar to determine a new safe area.

3 Settings

3.1 Activating/Deactivating securing

The number of securing stitches can be adjusted. Please find further information in the instruction «BERNINA Q 20 / Q 24».

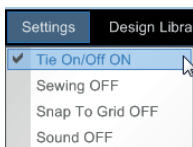

- > Touch «Settings → Tie On/Off ON» to deactivate securing.
 - The display changes from «Tie On/Off ON» to «Tie On/Off OFF» and is checked off.
- > Touch «Settings → Tie On/Off OFF» in the menu bar to activate securing.
 - The display changes from «Tie On/Off OFF» to «Tie On/Off ON» and is unchecked.

3.2 Sewing on/off

By selecting the respective menu item, it can be determined whether the machine is to sew design or to travel the design without sewing. This selection can be changed at any time.



- > Touch «Setting → Sewing OFF» in the menu bar to sew a quilt design.
 - The display changes from «Sewing OFF» to «Sewing ON» and is checked off.
- > Touch «Setting → Sewing ON» in the menu bar to travel a quilt design.
 - The display changes from «Sewing ON» to «Sewing OFF» and is unchecked.

3.3 Grid on/off

By activating the grid, the quilt design can be positioned more exactly. The quilt designs are drawn to the magnetic grid.

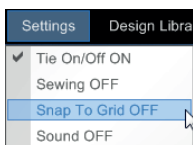

- > Touch «Setting → Snap to Grid OFF» in the menu bar to activate the magnetic grid.
 - The display changes from «Snap to Grid OFF» to «Snap to Grid ON» and is checked off.
- > Touch «Setting → Snap to Grid ON» in the menu bar to deactivate the magnetic grid.
 - The display changes from «Snap to Grid ON» to «Snap to Grid OFF» and is unchecked.

3.4 Signals on/off

With every activity on the display, an acoustic signal can be heard to confirm that the activity has been successful.

Please find further information concerning the signal selection in the instruction of the «PC/Monitor».

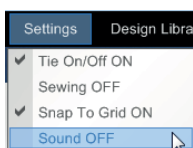

- > Touch «Settings → Sound OFF» to activate the signal.
 - The display changes from «Sound OFF» to «Sound ON» and is checked off.
- > Touch «Settings → Sound ON» to deactivate the signal.
 - The display changes from «Sound ON» to «Sound OFF» and is unchecked.

3.5 The needle is centered in the «Editing Display»

This function enables the machine to select a section of the quilt, which will then be displayed centered in the «Editing Display». Therefore it is always visible in the «Editing Display» where the needle is positioned.

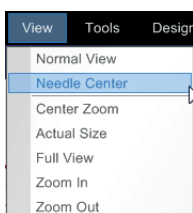

- > Touch «View → Needle center» in the menu bar.
 - The needle is positioned in the center of the «Editing Display». When the machine is moved, the needle **keeps** being positioned centered in the «Editing Display». Only the view of the «Editing Display» is changed.

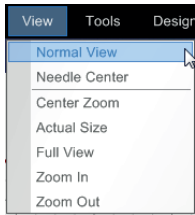

- > Touch «View → Normal View» in the menu bar.
 - The needle is detached from the center.

3.6 Changing the Easy Glide settings of the machine

The Easy Glide of the X- and Y-axis is improved, so that the machine can be moved easier. «Easy Glide» is **always** activated after a restart.



- > Touch the icon «Easy Glide».
 - The icon is deactivated until it is touched again.



- > In the menu bar, touch «Setting → Easy Glide».
 - A new screen is opened.
- > Touch the icon (1) or the icon (2) to adjust the support of the Easy Glide in the range of 0 - 20.
- > Touch the icon «Accept» (3) to confirm the entry.

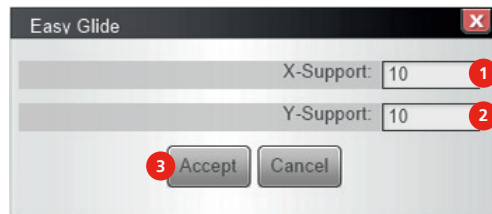

- The screen is closed and the previously made adjustments are saved.

4 Creative quilting

4.1 Selecting a quilt design

More than 230 quilt designs (Q-matic-System) and 350 quilt designs (Art & Stitch) are at your disposal.



- > Touch the icon «Add Design» to select quilt designs for the «Design Center».
- > Select the desired quilt design in the «Design Pool» (1).
- > Touch the selected quilt design twice in close succession to copy the quilt design to the «Design Center» (2).
 - In the «Design Pool» (1) the selected quilt design is highlighted in gray to indicate that this quilt design is already in the «Design Center» (2).
- > Touch the icon «Close» (3).

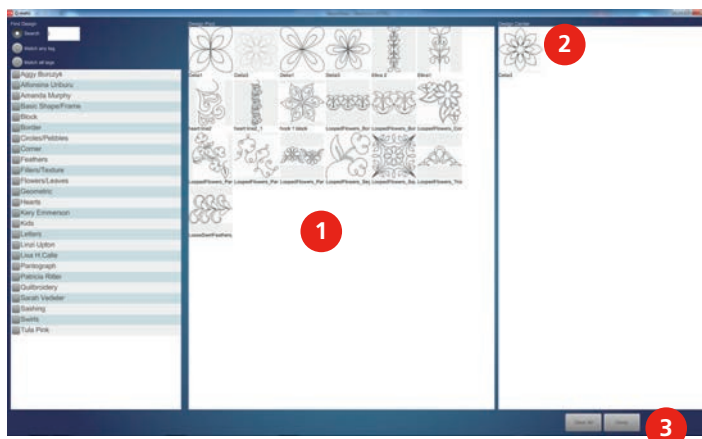

- The quilt design is visible in the «Design Center» (4).
- > Touch the quilt design in «Design Center» (4) twice in close succession to copy the quilt design to the «Editing Display» (5).
 - The quilt design is connected with the needle of the «Sewhead» automatically.

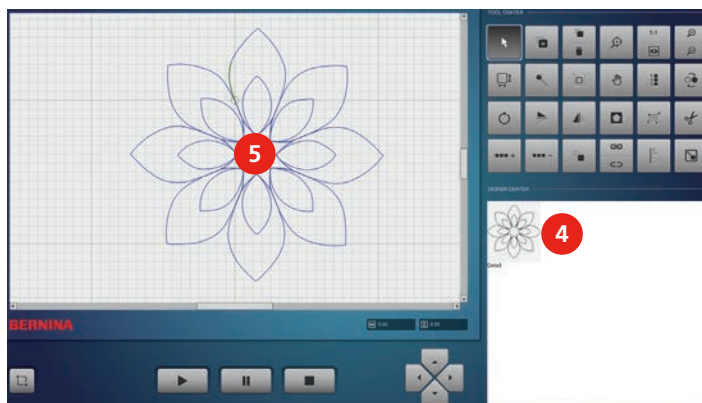

4.2 Deleting quilt designs from the «Design Center»

To facilitate the overview of the quilt designs, the quilt designs which are not needed anymore should be deleted.



- > Touch the icon «Add Design» to delete quilt designs from the «Design Center».
- > In the «Design Center» (1) touch a quilt design twice in close succession to delete a quilt design from the «Design Center» or

Clear All

> touch the icon «Clear All» (2) to delete all quilt designs from the «Design Center».

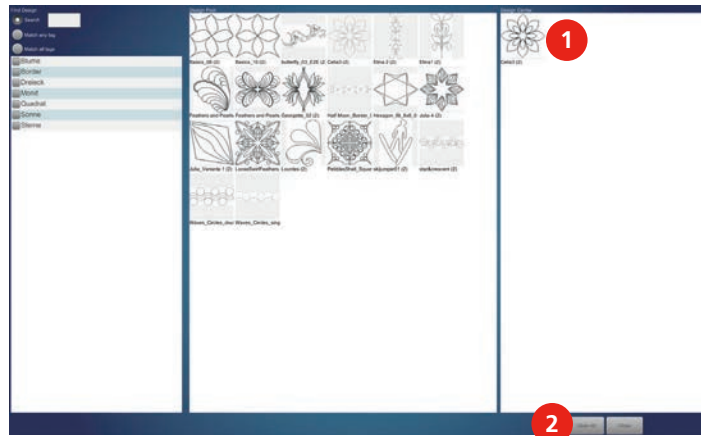

4.3 Searching quilt designs

Searching a quilt design via name or tag.



> Touch the icon «Add Design» to search quilt designs in the «Find Design».

> Enter the name, e.g. «bellflower» or the letter in the text box (1) and the located quilt designs will be displayed in the «Design Pool» (2).

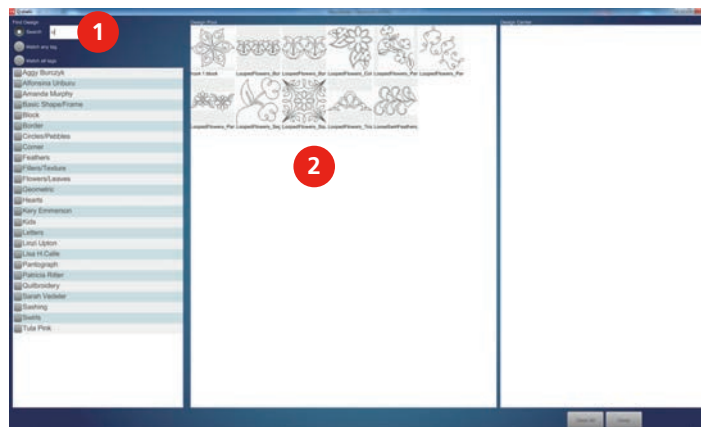

> Touch the icon «Match any tag» (3).

> Select the desired tags in the area (5) (see page 80).

– All of the quilt designs which contains at least **one** of these tags will appear in the «Design Pool» (2).

> Touch the icon «Match all tag» (4).



> Select the desired tags in the area (5).

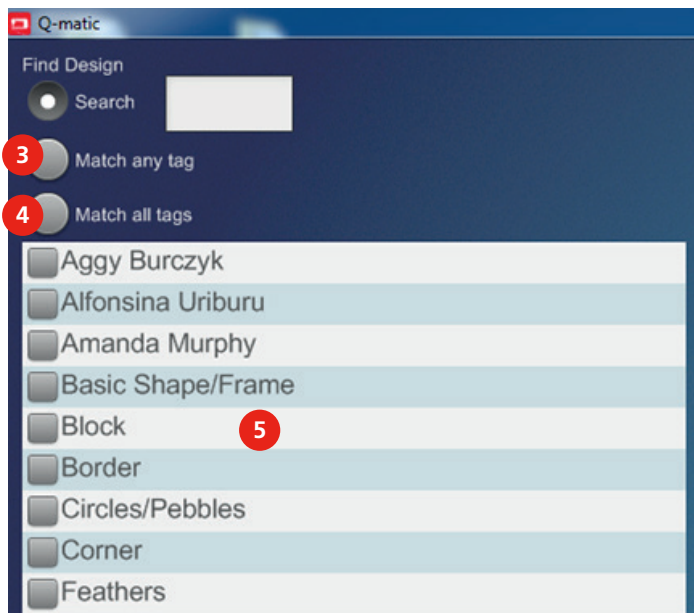

– All quilt designs which contain **all** of these tags will be displayed in the «Design Pool» (2).

4.4 Editing quilt designs

Calling up the Help

Prerequisite:

- The quilt design has been selected from the «Tool Center» and is visible in the «Editing Display».



- > Touch the icon «Select».
- > Activate the quilt design in the «Editing Display» with the finger.
- > Touch the icon «Markers», «Realign Safe Area», «Sew Option», «Mask», «Boundary», «Trim», «Multiply», «Connect», «Resize», «Rotate» or «Align».
 - A new screen is opened.



- > Touch the icon «Help» to open the Help Display.
 - Support concerning the selected functions is given in the display.

Moving quilt designs

Prerequisite:

- The quilt design has been selected from the «Tool Center» and is visible in the «Editing Display».



- > Touch the icon «Select» or

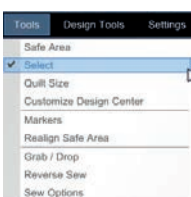

- > touch «Tools —> Select» in the menu bar.
- > Activate and move the quilt design in the «Editing Display» with the finger.
 - The active quilt design is colored in red.
- > Touch the icon «Select» again to deactivate the function.



Copying quilt designs

Prerequisite:

- The quilt design has been selected from the «Tool Center» and is visible in the «Editing Display».



- > Touch the icon «Select».
- > Activate the quilt design in the «Editing Display» with the finger.



- > Touch the upper icon «Copy» or

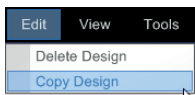

- > touch «Edit —> Copy Design» in the menu bar to copy the quilt design.
 - The copied quilt design is inserted directly behind the existing quilt design and therefore the quilt design is displayed darker.
- > Move the upper quilt design so that the copied quilt design appears in the «Editing Display».

Deleting quilt designs

Prerequisite:

- The quilt design has been selected from the «Tool Center» and is visible in the «Editing Display».



- > Touch the icon «Select».
- > Activate the quilt design in the «Editing Display» with the finger.



- > Touch the lower icon «Delete» or

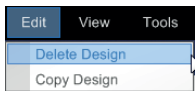

- > touch «Edit —> Delete Design» in the menu bar to delete the quilt design.

Zooming in the view of the quilt design at the desired position

The view of the quilt design can be zoomed in specifically at the desired position.

Prerequisite:

- The quilt design has been selected from the «Tool Center» and is visible in the «Editing Display».



- > Touch the icon «Center Zoom» or

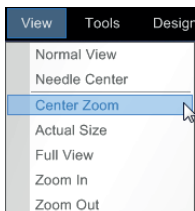

- > touch «View —> Center Zoom» in the menu bar.
- > In the «Editing Display» touch the position of the quilt design where the view is to be zoomed in.
- > Keep touching the same position until the wanted view size of the quilt design has been reached.



- > Touch the icon «Center Zoom» again to deactivate the function.

Changing the 1:1 view of the quilt design

The view of the quilt design can be changed to the 1:1 view.

Prerequisite:

- The quilt design has been selected from the «Tool Center» and is visible in the «Editing Display».



> Touch the upper icon «Actual Size 1:1» or

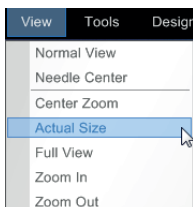

> touch «View —> Actual Size» in the menu bar to get to the 1:1-view.

Adapting the view of the quilt design to the size of the display

The view of the quilt design can be adapted to the size of the display.

Prerequisite:

- The quilt design has been selected from the «Tool Center» and is visible in the «Editing Display».



> Touch the lower icon «Full View» or

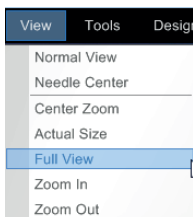

> touch «View —> Full View» in the menu bar to get to a view of the quilt design which fits the display.

Zooming the view of the quilt design in or out

The view of the quilt design can be zoomed in or out.

Prerequisite:

- The quilt design has been selected from the «Tool Center» and is visible in the «Editing Display».



> Touch the upper icon «Zoom In» or

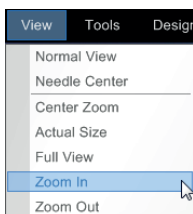

> touch «View —> Zoom In» in the menu bar to zoom in the view of the quilt design.



> Touch the lower icon «Zoom Out» or

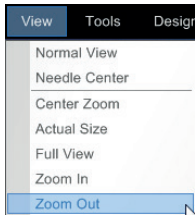

> touch «View → Zoom Out» in the menu bar to zoom out the view of the quilt design.

Entering the size of the quilt top

The size of the quilt top can be entered and appears in the «Editing Display» as a big red frame. Therefore it always visible how large the quilt is and the desired quilt designs or the Pantograph designs can be adjusted to the quilt size.

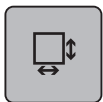

> Touch the icon «Quilt Size» or

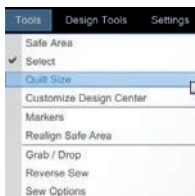

> touch «Tools → Quilt Size» in the menu bar.

> Touch the upper/lower icon «60.00».

– A new screen is opened.

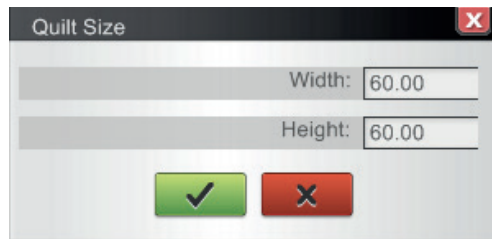

> Enter the width or the height of the quilt top via touching the calculator keys.

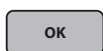

> Touch the icon «OK» to confirm the adjustments.



> Touch the icon «Confirm».

– The screen is closed and the previously made adjustments are saved. In the «Editing Display» a red frame appears which is equal to the size of the quilt top.

Placing and deleting markers

Markers can be placed which help to position quilt designs exactly. Moreover, these markers can be connected with each other. Afterwards the line can be moved, edited and sewn out like a quilt design

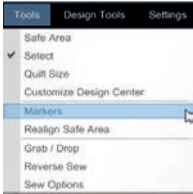

- > Touch the icon «Markers» or
- > touch «Tools —> Markers» in the menu bar.
- > Move the «Sewhead» to the desired marker.
- > In the «Sewhead Display» touch the icon «Set» or press any handle button.
 - The marker is positioned and appears in the «Editing Display».
- > Place further markers and with each additional marker touch the icon «Set» or press any handle button.
- > Touch the icon (1) to connect the markers with each other.
- > Touch all the markers in the «Editing Display» in sequence.
 - The markers are connected with a line.
- > Touch the icon (2) to have the center of all markers displayed.
- > Touch the icon «Confirm».

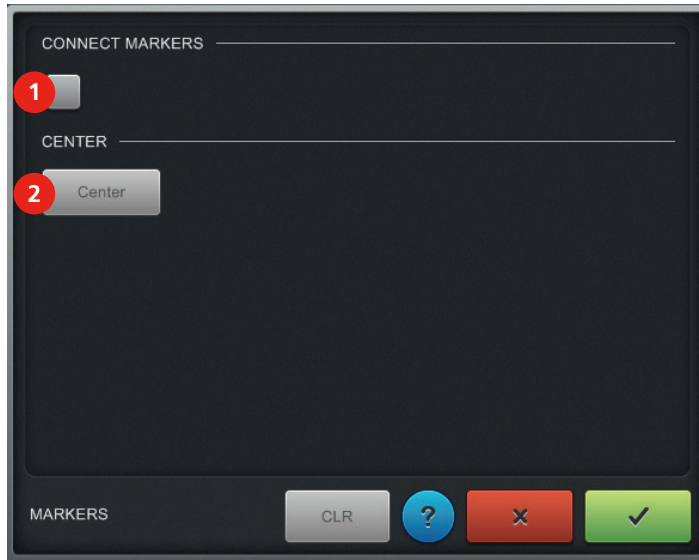

- The screen is closed and the previously made adjustments are saved.



- > Touch the icon «Markers» again.
- > Touch the icon «CLR» to delete all markers. The connection lines remain active like a quilt design.

Realigning the safe area in the «Editing Display»



When planning a quilt with applique or embroidery, use the foot 43 or the foot 44C (Optional accessory). These feet with the round soles can glide easily on uneven surfaces.

«»This function is particularly used for Pantograph quilting. The «Safe Area »can be moved and realigned in the «Editing Display» so that the following rows of a Pantograph can be sewn exactly and accurately.

Prerequisite:

- A Pantograph has been created in the «Editing Display» and the first rows of the Pantograph have already been quilted.



- The «Safe Area» is large enough so that at least one row of a Pantograph can be placed.

- > Roll up the quilt.
- > Touch the icon «Realign Safe Area» or

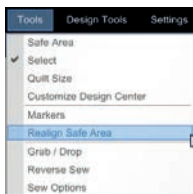

- > touch «Tools —> Realign Safe Area» in the menu bar.
- > Touch the icon (1).
- > Move the needle/sewhead to a reference point in the previously sewn quilt design, near the diverting bar.
- > Move the cross hairs in the «Editing Display» to the same reference point of the quilt design.
 - The «Safe Area» is moved by moving the cross hairs.



- > Touch the icon «Confirm».
 - The screen is closed and the previously made adjustments are saved.
- > The following rows of the Pantograph can be quilted.

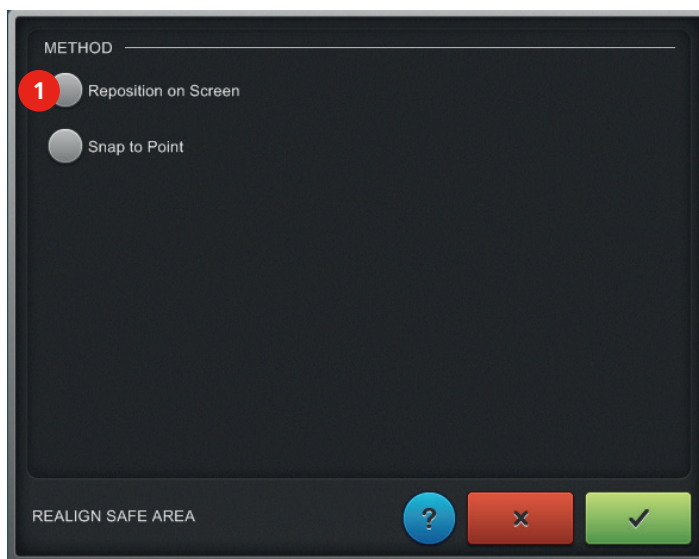

Realigning the safe area at the reference point



When planning a quilt with applique or embroidery, use the foot 43 or the foot 44C (Optional accessory). These feet with the round soles can glide easily on uneven surfaces.

This function is particularly used for Pantograph quilting. The «Safe Area» can be moved and realigned on the base of one of the reference point so that the next rows of the Pantograph can be sewn exactly and accurately.

Prerequisite:

- A Pantograph has been created in the «Editing Display» and the first rows of the Pantograph have already been quilted.
 - The «Safe Area» is large enough so that at least one row of a Pantograph can be placed.
- > Roll up the quilt.
 - > Zoom the quilt design in (see page 42) to position the reference point more exactly.
 - > Touch the icon «Realign Safe Area» or



Creative quilting

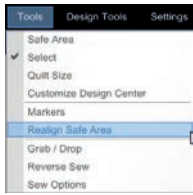

- > touch «Tools —> Realign Safe Area» in the menu bar.
- > Touch the icon (2).
- > Touch a reference point of the previously sewn quilt design in the «Editing Display» to determine a red reference point. The reference point can be repositioned several times.
 - Move the needle/sewhead to the previously selected reference point on the quilt.
- > Touch the icon «Confirm».
 - The screen is closed, the previously made adjustments are saved and the «Safe Area» is realigned so that the following rows of the Pantograph can be quilted.
- > The following rows of the Pantograph can be quilted.

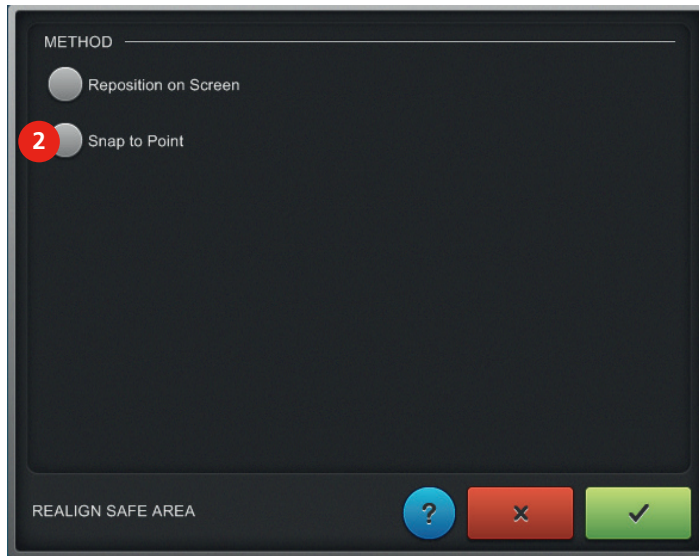

Grab and drop

The quilt design can be moved and exactly positioned by the machine

Prerequisite:

- The quilt design has been selected from the «Tool Center» and is visible in the «Editing Display».

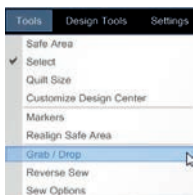

- > Touch the icon «Select» or
- > touch «Tools —> Grab and drop» in the menu bar.
- > Activate the quilt design in the «Editing Display» with the finger.
- > Touch the icon «Grab/Drop» to connect the starting point of the selected quilt design with the needle of the «Sewhead».
 - The quilt design can now be moved and positioned by the machine.
- > Touch the icon «Grab/Drop» again to disconnect the starting point of the selected quilt design from the needle of the «Sewhead».



Defining the sewing sequence



As soon as a quilt design has been sewn out, it will be automatically taken out of the waiting line. To sew it again, it has to be taken back to the waiting line again.

The quilt designs can be sewn in a defined sequence. The quilt designs can also be placed in the waiting line to be sewn at a later time.

Prerequisite:

- The quilt design has been selected from the «Tool Center» and is visible in the «Editing Display».

> Touch the icon «Sew Options» or



> touch «Tools —> Sew Options» in the menu bar.

> Touch the icon (1).

> Touch the quilt designs in the «Editing Display» according to the desired sequence in which they are to be sewn.

- The quilt designs are numbered.

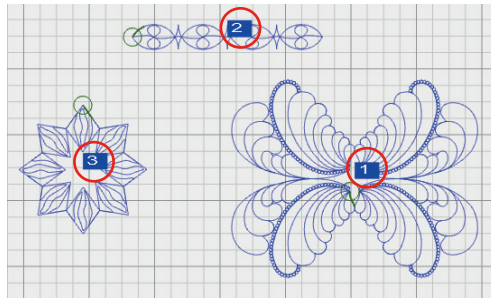
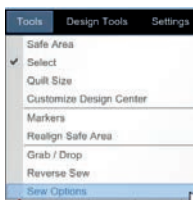

> Touch the icon «Confirm».

- The screen is closed and the previously made adjustments are saved.

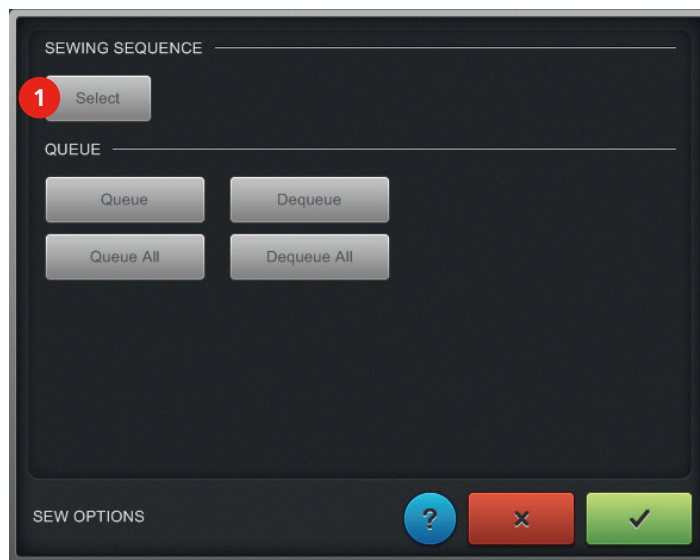

Put quilt patterns in a waiting queue or remove it

If you do not want to proceed a pattern on the quilt, it can be removed from the queue and be sewn later. Is a quilt patterns not in the queue, it is colored light gray. If you want to proceed a design, it can be placed in the queue again to be sewn.

Prerequisite:

- The quilt design has been selected from the «Tool Center» and is visible in the «Editing Display».



> Touch the icon «Sew Options» or

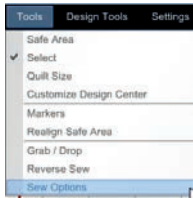

> touch «Tools —> Sew Options» in the menu bar.

> Touch the icon «Confirm».

- The screen is closed and the previously made adjustments are saved.



> Touch the icon «Sew Options» again.

> Touch the icon (1).

> Touch one quilt design in the «Editing Display» to place the quilt design in the waiting line.

- The quilt design turns blue.

> Touch the icon (2).

> Touch the blue colored quilt design in the «Editing Display» to remove the quilt design from the waiting line.

- The quilt design turns gray and cannot be sewn anymore.

> Touch the icon (3) to place all quilt designs in the waiting line.

- All quilt designs turn blue.

> Touch the icon (4) to remove all quilt designs from the waiting line.

- All quilt designs turn gray and cannot be sewn anymore.



> Touch the icon «Confirm».

- The screen is closed and the previously made adjustments are saved.



Changing the sewing direction

The starting and the end point of a quilt design is changed.

Prerequisite:

- The quilt design has been selected from the «Tool Center» and is visible in the «Editing Display».



- > Touch the icon «Select».
- > Activate the quilt design in the «Editing Display» with the finger.



- > Touch the icon «Reverse Sew» or

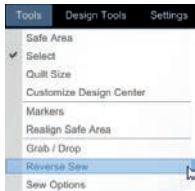

- > touch «Tools —> Reverse Sew» in the menu bar to change the sewing direction.

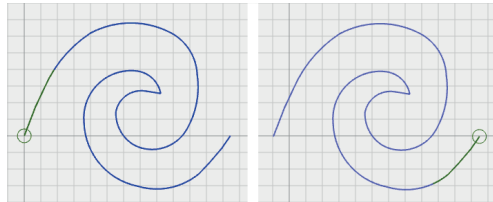

Rotating quilt designs

The quilt design can be rotated in single degree steps or manually. The red point is the center of rotation around which the quilt design will revolve. Every point can be chosen as rotation center.

Prerequisite:

- The quilt design has been selected from the «Tool Center» and is visible in the «Editing Display».



- > Touch the icon «Select».
- > Activate the quilt design in the «Editing Display» with the finger.



- > Touch the icon «Rotate» or

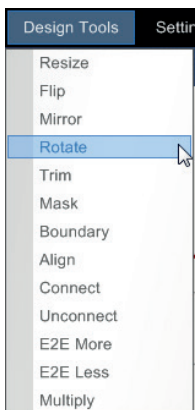

- > touch «Design Tools —> Rotate» in the menu bar.
 - The quilt design is given a grid with nine different points.

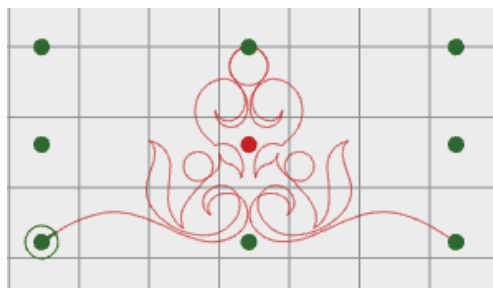

- > Rotate the quilt design around the red point to the left or to the right with the finger.
- > Touch one of the green points and keep pressed until the green point turns red.
 - The red point will be the new rotation center.
- > Rotate the quilt design around the red point to the left or to the right with the finger.

- > Touch the icon (1) to enter the degree of rotation via pressing the keys of the calculator.

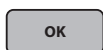
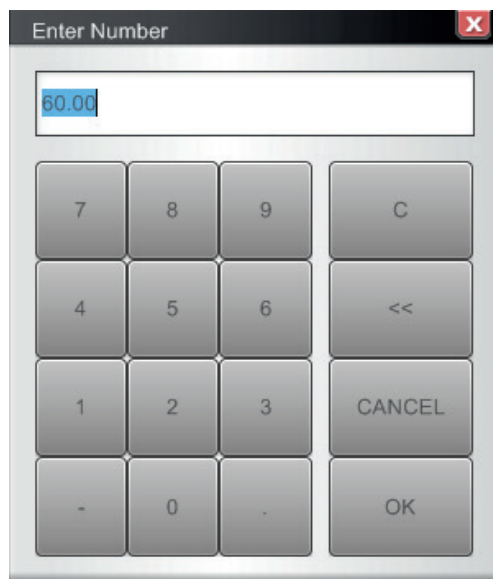

- > Touch the icon «OK».



- > Touch the icon «Apply» (2) to confirm the adjustments.
- > Touch the icon (3) to rotate the quilt design in 0.1°-steps clockwise.
- > Touch the icon (4) to rotate the quilt design in 5°-steps clockwise.
- > Touch the icon (5) to rotate the quilt design in 45°-steps clockwise.
- > Touch the icon (6) to rotate the quilt design in 0.1°-steps counterclockwise.
- > Touch the icon (7) to rotate the quilt design in 5°-steps counterclockwise.
- > Touch the icon (8) to rotate the quilt design in 45°-steps counterclockwise.
- > Touch the icon (9) to move the red point automatically to the starting point of the quilt design.



- > Touch the icon «Confirm».
- The screen is closed and the previously made adjustments are saved.

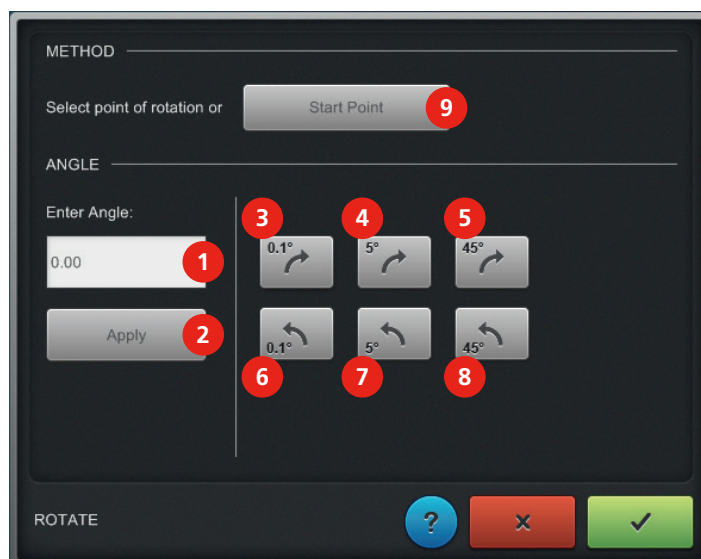

Mirroring quilt designs

The quilt designs can be mirrored vertically as well as horizontally.

Prerequisite:

- The quilt design has been selected from the «Tool Center» and is visible in the «Editing Display».



- > Touch the icon «Select».
- > Activate the quilt design in the «Editing Display» with the finger.



- > Touch the icon «Flip» or

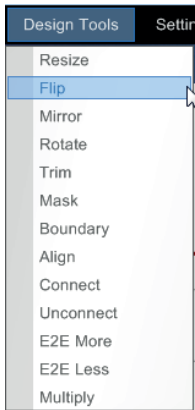

- > touch «Design Tools —> Flip» in the menu bar to mirror the quilt design sideways (vertically).



- > Touch the icon «Mirror» or

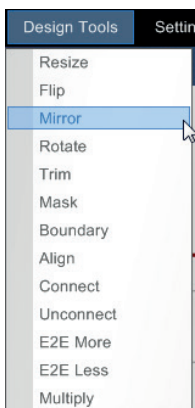

- > touch «Design Tools —> Mirror» in the menu bar to mirror the quilt design lengthwise (horizontally).

Masking quilt designs using «Design»

A quilt design can be masked with another quilt design. In doing so, it can be decided whether everything inside the mask (mask inside) or outside the mask (mask outside) is to be deleted.

Prerequisite:

- Both quilt designs have been selected from the «Tool Center» and are visible in the «Editing Display» and have already been positioned correctly. The quilt design to be masked is activated.



- > Touch the icon «Mask» or

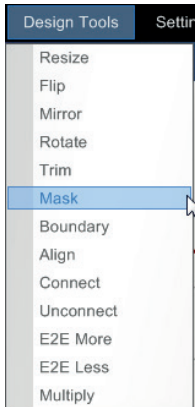

- > touch «Design Tools → Mask» in the menu bar.
 - In section (1) the icon «Screen» and in section (2) the icon «Selected Design» must be selected.
- > Activate the quilt design which is to serve as mask in the «Editing Display» with the finger.
 - The mask turns black.

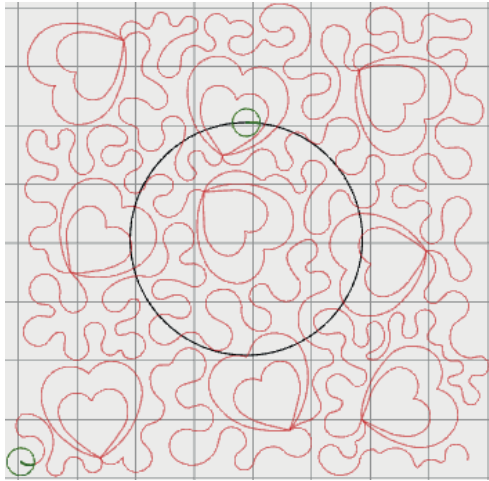

- > In section (3) touch the icon «Outside».
- > Touch the icon (4) to have the outline sewn as well.
- > Touch the icon «Preview» to check the settings.
 - The quilt design will be deleted outside the mask and the outline is sewn.



- > Touch the icon «CLR» to delete the preview.
- > In section (3) touch the icon «Inside».
- > In section (4) touch the icon again to deactivate the outline.



Preview

- > Touch the icon «Preview» to check the settings.
 - The quilt design will be deleted inside the mask and the outline is **not** sewn.

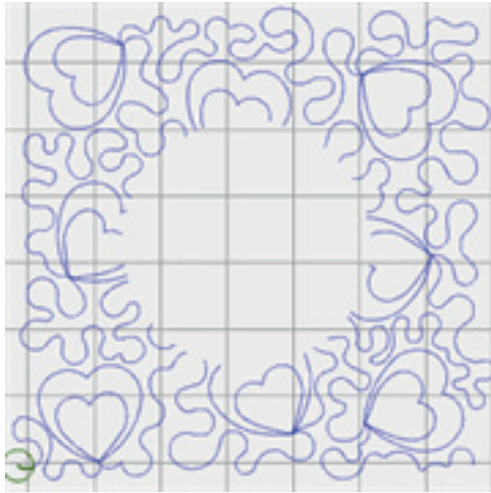

✓

- > Touch the icon «Confirm».
 - The screen is closed and the previously made adjustments are saved.

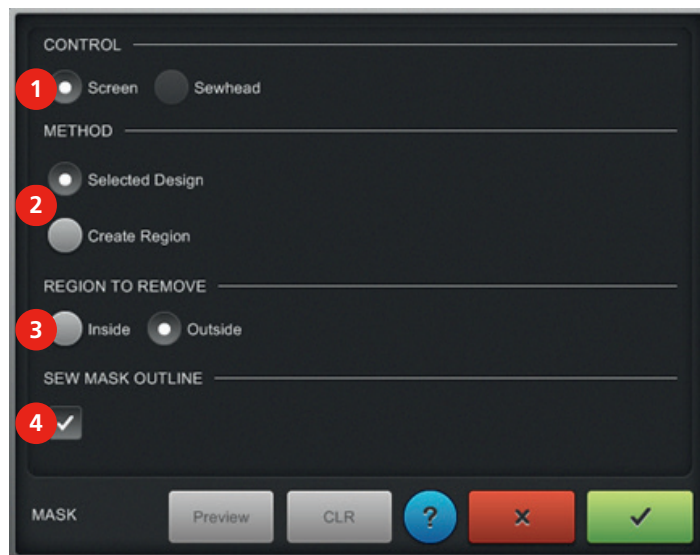

Masking quilt designs using «Create Region» via the «Sewhead»

A quilt design can be masked within an entered form in the «Sewhead». The starting and end line do not have to be closed imperatively because they will be closed automatically as soon as «Confirm» has been touched.

Prerequisite:

- The quilt design has been selected from the «Tool Center» and is visible in the «Editing Display».

- > Touch the icon «Mask» or



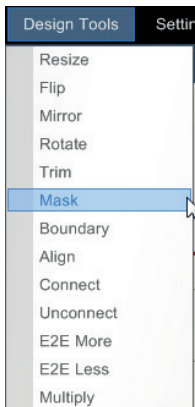

- > touch «Design Tools → Mask» in the menu bar.
- > In section (2) touch the icon «Create Region».
- > In section (1) select the icon «Sewhead».
- > Place points on the quilt clockwise or counter clockwise.
- > In the «Sewhead Display» touch the icon «Set» or press any handle button to place the starting point.
- > Place the next point to connect the points with lines.
- > Place the next point until the mask is created and closed.



- > In section (3) touch the icon «Outside».
- > Touch the icon (4) to have the outline sewn.
- > Touch the icon «Preview» to check the settings.
 - The quilt design will be deleted outside the mask and the outline is sewn.



- > Touch the icon «CLR» to delete the preview.
- > Place masking points again.
- > In section (3) touch the icon «Inside».
- > In section (4) touch the icon again to deactivate the outline.



- > Touch the icon «Preview» to check the settings.
 - The quilt design will be deleted inside the mask and the outline is **not** sewn.



- > Touch the icon «Confirm».
- The screen is closed and the previously made adjustments are saved.

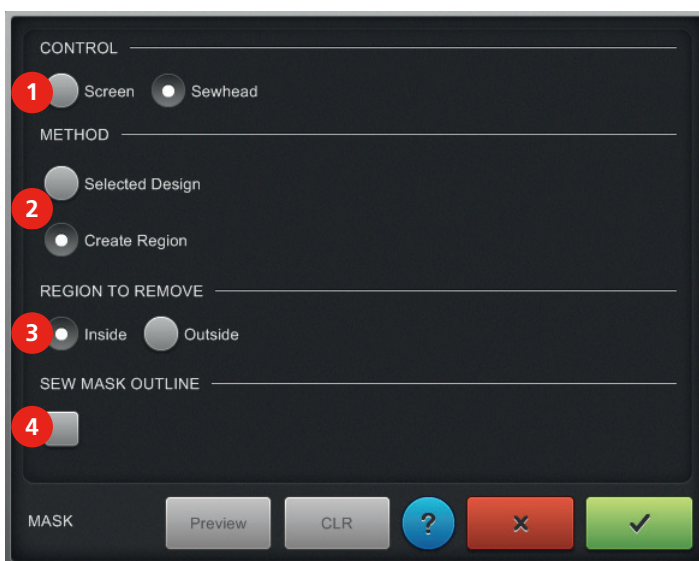

Masking quilt designs using «Create Region» in the «Editing Display»

A quilt design can be masked with an entered form in the «Screen». The starting and end line do not have to be closed imperatively because they will be closed automatically as soon as «Confirm» has been touched.

Prerequisite:

- The quilt design has been selected from the «Tool Center» and is visible in the «Editing Display».

> Touch the icon «Mask» or

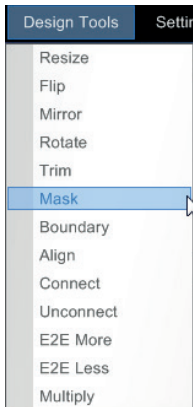

> touch «Design Tools → Mask» in the menu bar.

> In section (2) touch the icon «Create Region».

> In section (1) select the icon «Screen».

> Press the finger on the «Editing Display» to place the starting point of the mask.

> Place the next point to connect the points with lines.

> Place the next point until the mask is created and closed.

- The mask will turn black.



> In section (3) touch the icon «Outside».

> Touch the icon (4) to have the outline sewn.

> Touch the icon «Preview» to check the settings.

- The quilt design will be deleted outside the mask and the outline is sewn.

Preview

> Touch the icon «CLR» to delete the preview.

> Place masking points again.

> In section (3) touch the icon «Inside».

> In section (4) touch the icon again to deactivate the outline.

> Touch the icon «Preview» to check the settings.

- The quilt design will be deleted inside the mask and the outline is **not** sewn.

Preview





- > Touch the icon «Confirm».
- The screen is closed and the previously made adjustments are saved.

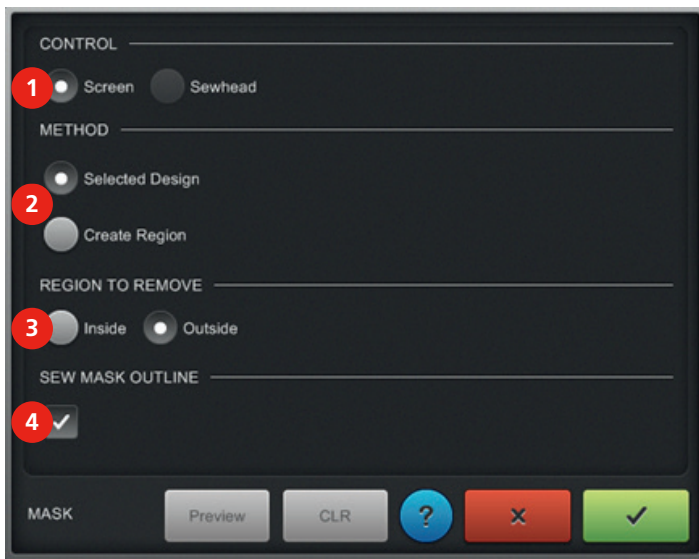

Defining a boundary via the «Sewhead»

Using this function, the boundary can be defined via the «Sewhead». This boundary mustn't be exceeded by the subsequently inserted quilt design. You can choose whether the proportion are to be maintained or whether it is to be distorted.

Prerequisite:

- A quilt design has been selected from the «Tool Center» and is visible in the «Editing Display».



- > Touch the icon «Select».
- > Activate a quilt design in the «Editing Display» with the finger.



- > Touch the icon «Boundary» or

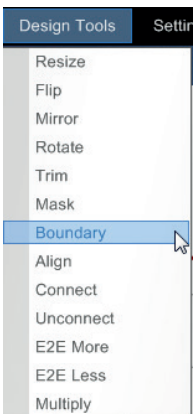

- > touch «Design Tools —> Boundary» in the menu bar.
- > In section (1) select «Sewhead» to define the boundary points via the «Sewhead».
- > Place **four** points on the quilt either clockwise or counterclockwise.
- > Select the first boundary point in the «Sewhead Display».
- > In the «Sewhead Display» touch the icon «Set» or any handle button.
- > Select three other boundary points and confirm them in the «Sewhead Display».
- > In section (2) touch the icon «Maintain Ratio».



Preview

> Touch the icon «Preview» to position the proportional quilt design within the boundary area.

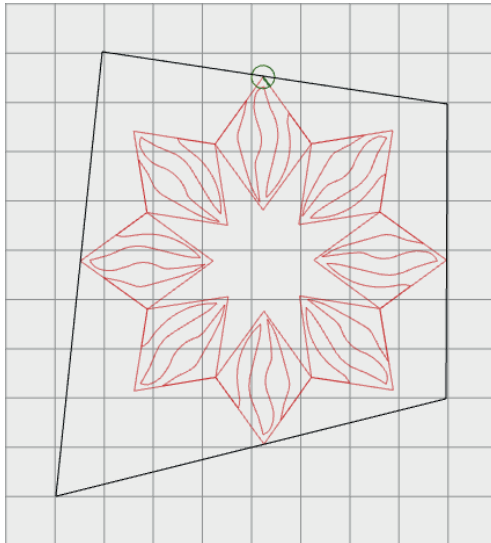

CLR

> Touch the icon «CLR» to delete the settings.
 > Place four new boundary points via the «Sewhead».
 > In section (2) select «Morph to Fit».

Preview

> Touch the icon «Preview» to position the unproportional quilt design within the boundary area.

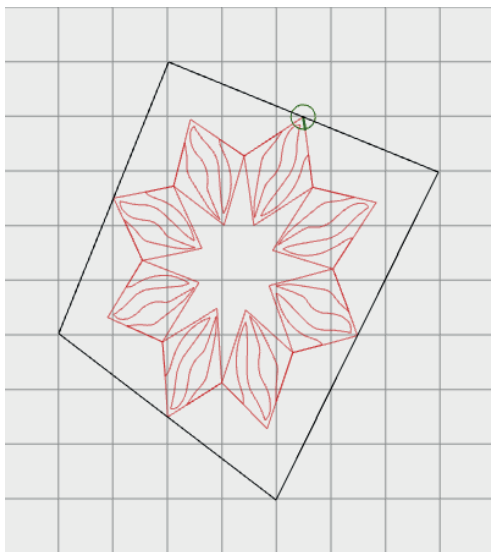

CLR

> Touch the icon «CLR» to delete the settings.
 > Place four new boundary points via the «Sewhead».
 > Touch the icon (3).
 > To position the quilt design at a distance to the boundary line, enter a positive value in inch (e. g. 0.5).
 > To position the quilt design over the boundary line, enter a negative value in inch (e. g. -0.5).

OK

> Touch the icon «OK».

Preview

> Touch the icon «Preview».





> Touch the icon «Confirm» to confirm the settings.

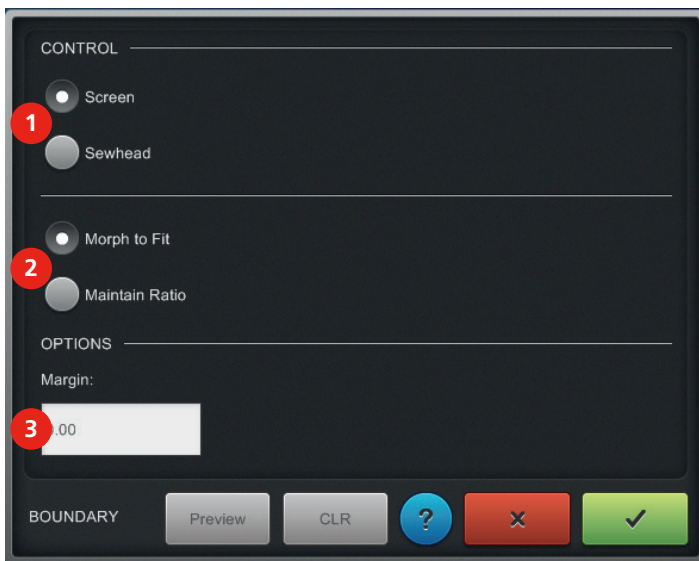

Defining a boundary in the «Editing Display»

Using this function, a boundary can be defined in the «Editing Display» and this boundary mustn't be exceeded by the subsequently inserted quilt design. You can choose whether the proportion are to be maintained or whether it is to be distorted.

Prerequisite:

- A quilt design has been selected from the «Tool Center» and is visible in the «Editing Display».



> Touch the icon «Select».

> Activate a quilt design in the «Editing Display» with the finger.



> Touch the icon «Boundary» or

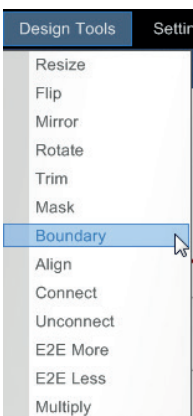

> touch «Design Tools —> Boundary» in the menu bar.

> In section (1) «Screen» is selected to place the boundary points in the «Editing Display».

> In the «Editing Display» place **four** points clockwise or counterclockwise.

> In section (2) select «Maintain Ratio».



Preview

> Touch the icon «Preview» to position the proportional quilt design within the boundary area.

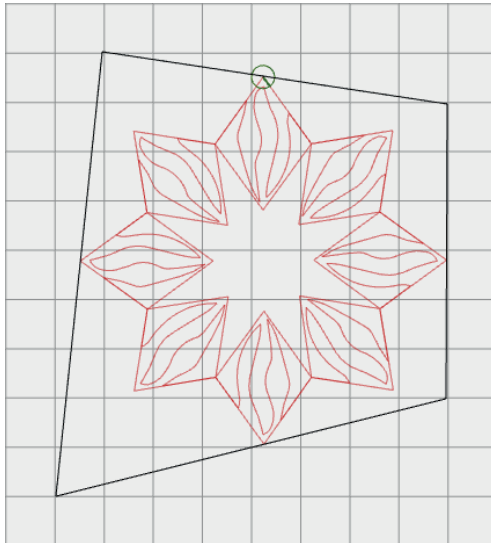

CLR

> Touch the icon «CLR» to delete the settings.
 > Place four new boundary points.
 > In section (2) select «Morph to Fit».

OK

> Touch the icon «OK».

Preview

> Touch the icon «Preview» to position the unproportional quilt design within the boundary area.

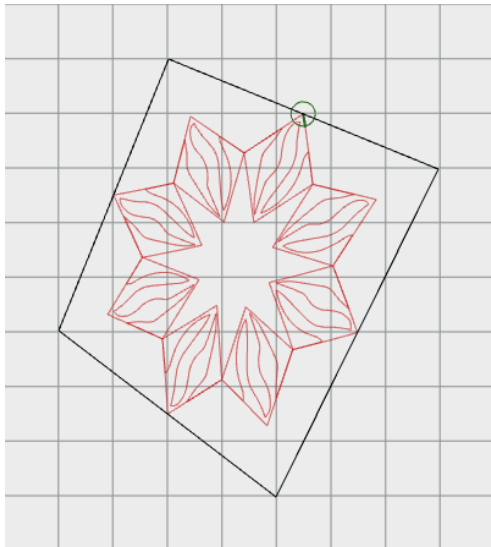

CLR

> Touch the icon «CLR» to delete the settings.
 > Place four new boundary points.
 > Touch the icon (3).
 > To position the quilt design at a distance to the boundary line, enter a positive value in inch (e. g. 0.5).
 > To position the quilt design over the boundary line, enter a negative value in inch (e. g. -0.5).

OK

> Touch the icon «OK».

Preview

> Touch the icon «Preview».





> Touch the icon «Confirm» to confirm the settings.

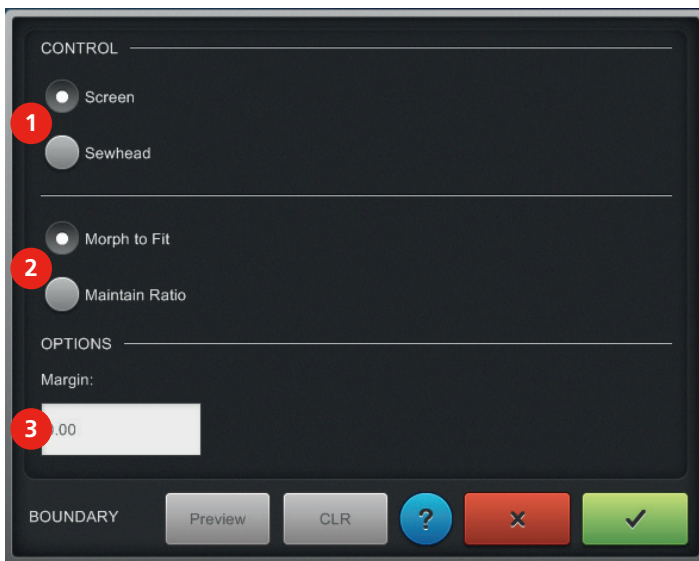

Trimming quilt designs via the «Sewhead»

The quilt designs can be trimmed in different ways. They can be trimmed horizontally, vertically or by means of a rotation center. Additionally you have the option to decide which quilt design part has to be trimmed.

Prerequisite:

- The quilt design has been selected from the «Tool Center» and is visible in the «Editing Display».



- > Touch the icon «Select».
- > Activate the quilt design in the «Editing Display» with the finger.



- > Touch the icon «Trim» or

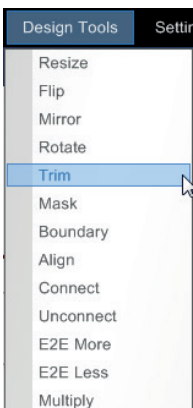

- > touch «Design Tools —> Trim» in the menu bar.
- > In section (1) touch «Sewhead» to define the cutting line via the «Sewhead».
- > In section (2) touch «Entire Quilt» to trim the **complete** quilt.
- > In section (2) touch «Selected Design» to trim **one** quilt design.
- > In section touch (3) touch «Horizontal» to define the cutting line accordingly.
- > Move the «Sewhead» to the desired point.



- > In the «Sewhead Display» touch the icon «Set» or any other handle button to define a horizontal cutting line.
 - A red line appears in the «Editing Display» and the quilt design has turned black **above** the line. The part colored in black will be trimmed.

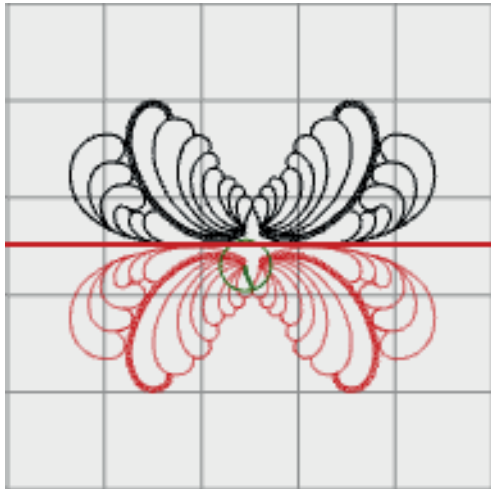

- > Touch the icon (4) to switch the trimmed area.
 - The quilt design has now turned black **beneath** the line.

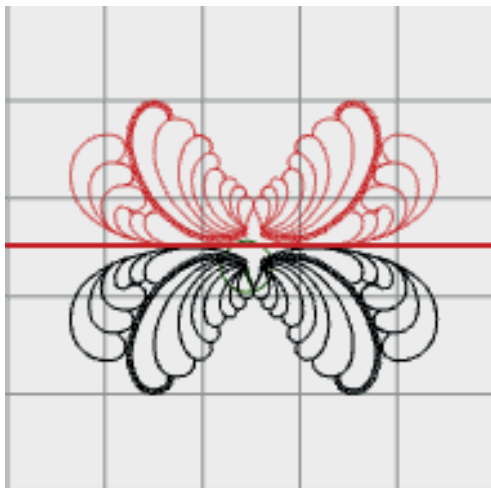

- > Touch the icon (4) again to switch the trimmed area again.
- > Move the «Sewhead» to reposition the cutting line.
- > In the «Sewhead Display» touch the icon «Set» or any other handle button to define a horizontal line.
- > In section (3) touch «Vertical» to define a vertical line via the «Sewhead».
- > In section (3) touch «Angle» to define a cutting line with a rotation point via the «Sewhead».
 - The first point which has been placed with «Angle» is and remains the rotation point.
- > Move the «Sewhead» to the desired point to place the rotation point and a cutting line. To reposition the cutting line, move the «Sewhead» again.
- > In the «Sewhead Display» touch the icon «Set» or any other handle button to place a new cutting line.
- > If the rotation point is to be repositioned, touch the icon «Close» and touch the icon «Trim» again.
- > Touch the icon (5) to connect the trimmed quilt design with a jump stitch.
- > Touch the icon (5) again to connect the trimmed quilt design with a joining seam.
- > Touch the icon «Preview» to check the settings.
- > Touch the icon «CLR» to delete the preview or

CLR



- > touch the icon «Confirm».
- The screen is closed and the previously made adjustments are saved.



Trimming quilt designs in the «Editing Display»

Prerequisite:

- The quilt design has been selected from the «Tool Center» and is visible in the «Editing Display».



- > Touch the icon «Select».
- > Activate the quilt design in the «Editing Display» with the finger.



- > Touch the icon «Trim» or

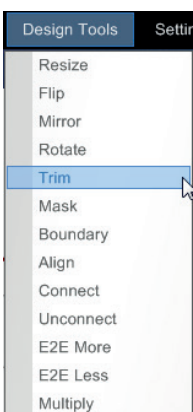

- > touch «Design Tools —> Trim» in the menu bar.
- > In section (1) touch «Screen» to define the cutting line in the «Editing Display».
- > In section (2) touch «Entire Quilt» to trim the **complete** quilt.
- > In section (2) touch «Selected Design» to trim **one** quilt design.
- > In section (3) touch «Horizontal» to place the cutting line accordingly.



- > Touch the «Editing Display» to place a horizontal cutting line accordingly. To reposition the cutting line, touch the «Editing Display» again.
 - A red line appears in the «Editing Display» and the quilt design turns black **above** the line. The black colored part of the quilt design will be trimmed.

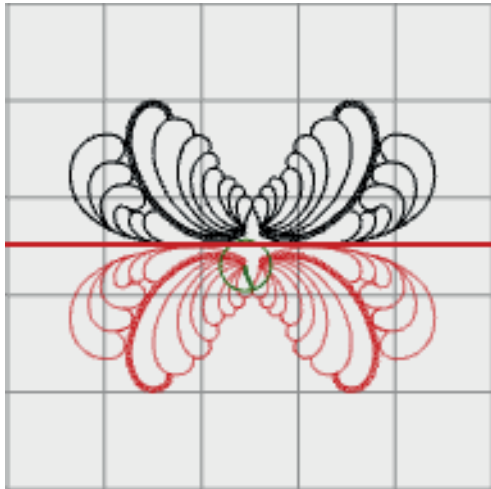

- > Touch the icon (4) to switch the trimmed area.
 - The quilt design has now turned black **beneath** the line.

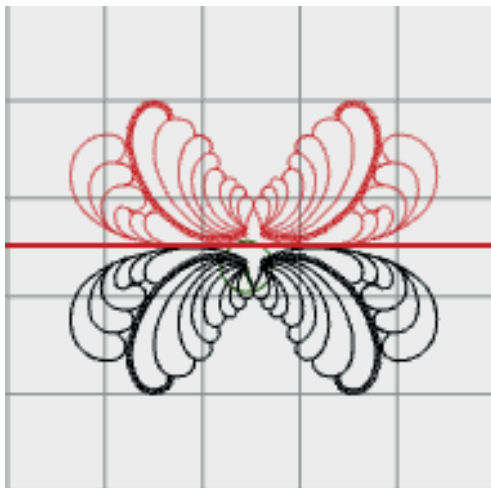

- > Touch the icon (4) again to switch the trimmed area again.
- > In section (3) touch «Vertical» to place a vertical cutting line.
- > In section (3) touch «Angle» to place a cutting line with a rotation point.
 - The first point which has been placed with «Angle» is and remains the rotation point.
- > If the rotation point is to be repositioned, touch the icon «Close» and touch the icon «Trim» again.
- > Touch the icon (5) to connect the trimmed quilt design with a jump stitch.
- > Touch the icon (5) again to connect the trimmed quilt design with a joining seam.
- > Touch the icon «Preview» to check the settings.
- > Touch the icon «CLR» to delete the preview or



- > touch the icon «Confirm».
- The screen is closed and the previously made adjustments are saved.



Duplicating quilt designs (E2E)

The quilt design is duplicated and at the same time the endpoint of the first quilt design is joined with the starting point of the new quilt design. The quilt design can be duplicated and joined several times. By using this function, a Pantograph can be created very quickly and easily. A quilt design which has the same starting and end point **cannot** be duplicated as Pantograph.

Prerequisite:

- A quilt design **which is suitable for a Pantograph** has been selected from the «Tool Center» and is visible in the «Editing Display».



- > Touch the icon «Select».
- > Activate the quilt design in the «Editing Display» with the finger.

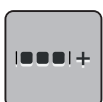

- > Touch the icon «E2E more» or

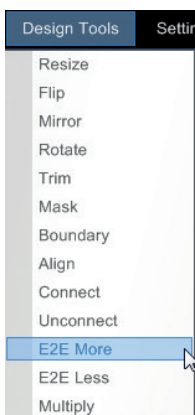

- > touch «Design Tools → E2E more» in the menu bar to duplicate and join the quilt design at the same time.

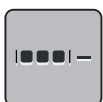

- > Touch the icon «E2E less» or



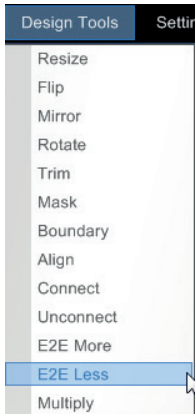

- > touch «Design Tools → E2E less» in the menu bar to delete the quilt design and to delete the connection at the same time.

Multiple duplication of quilt designs

Multiple duplication allows almost unlimited creativity. You can rotate the quilt designs horizontally and vertically or both in combination. As well the spaces between the quilt designs can be increased or reduced.

In this instruction manual only the section (1) is explained, as the application in section (2) is exactly the same except that the quilt designs will be duplicated vertically and not horizontally. Quilt designs which are not suitable for a Pantograph can also be duplicated. A design that has the same start and end point is not suitable as a pantograph.

Prerequisite:

- A quilt design **which is suitable for a Pantograph** has been selected from the «Tool Center» and is visible in the «Editing Display».



- > Touch the icon «Select».
- > Activate the quilt design in the «Editing Display» with the finger.



- > Touch the icon «Multiply» or

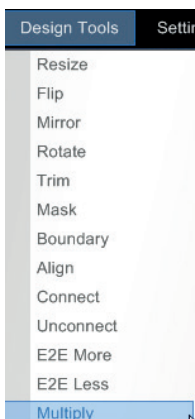

- > touch «Design Tools → Multiply» in the menu bar.
- > In section (1) enter the desired number or quilt designs via the icons «-» or «+» or
- > enter the number of the desired number or quilt designs directly in the white box (between «-»/«+») by pressing the keys of the calculator.



- OK > Touch the icon «OK».
- Preview > Touch the icon «Preview» to check the adjustments.
- CLR > Touch the icon «CLR» to delete the preview.
- CLR > In section (1) touch the icon «Hor» and/or «Vert» and touch the icon «All» to mirror **all** quilt designs horizontally or vertically.
- Preview > Touch the icon «Preview» to check the adjustments.
- CLR > Touch the icon «CLR» to delete the preview.
- CLR > In section (1) touch the icon «Hor» and/or «Vert» and the icon «Alt» to mirror every **second** quilt design horizontally or vertically.
- Preview > Touch the icon «Preview» to check the adjustments.
- CLR > Touch the icon «CLR» to delete the preview.
- CLR > In section (3) adjust the horizontal distance (in inch) between the quilt designs by touching the icons «-» or «+» or
- CLR > enter the desired distance directly in the white box (between «-»/«+») by touching the keys of the calculator.
- OK > Touch the icon «OK» to confirm the adjustments.
- OK > In section (4) adjust the vertical distance (in inch) between the quilt designs by touching the icons «-» or «+» or
- OK > enter the desired distance directly in the white box (between «-»/«+») by touching the keys of the calculator.
- OK > Touch the icon «OK» to confirm the adjustments.
- OK > In section (5) adjust the offset (in inch) of each **second** quilt design row via the icons «-» or «+» or
- OK > enter the desired offset directly in the white box (between «-»/«+») by pressing the keys of the calculator.
- OK > Touch the icon «OK» to confirm the adjustments.
- Preview > Touch the icon «Preview» to check the adjustments.
- CLR > Touch the icon «CLR» to delete the preview or
- ✓ > Touch the icon «Confirm».
 - The screen is closed and the previously made adjustments are saved.



Connecting quilt designs

There are three ways to connect quilt designs with each other.

Prerequisite:

- A number of quilt designs have been selected from the «Tool Center» and are visible in the «Editing Display».



- > Touch the icon «Select».
- > Activate a quilt design in the «Editing Display» with the finger.



- > Touch the upper icon «Connect» or

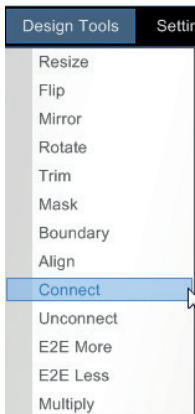

- > touch «Design Tools —> Connect» in the menu bar.
- > Touch the icon «Group» (1).
- > In the «Editing Display» select another quilt design with the finger.
 - The quilt designs are grouped together and can be edited as one quilt design. They remain in their position and are sewn as a group.
- > Select other quilt designs to extend the group as you like.
 - The quilt designs are sewn in the sequence as they have been selected.



- > Touch the icon «Confirm».
 - The screen is closed and the previously made adjustments are saved.
- > Touch the icon «Connect» again.
- > Touch the icon «Attach» (2).
- > In the «Editing Display» select another quilt design with the finger.
 - The starting point of the quilt design is joined with the endpoint of the first quilt design. Now it is considered as **one** quilt design.



- > Touch the icon «Confirm».
 - The screen is closed and the previously made adjustments are saved.
- > Touch the icon «Connect» again.
- > Touch the icon «Link» (3).
- > In the «Editing Display» select another quilt design with the finger.
 - The starting point the quilt design is joined with the endpoint of the first quilt design by a joining seam. The joined quilt designs remain at their position and are sewn as one quilt design.



- > Touch the icon «Confirm».
- The screen is closed and the previously made adjustments are saved.

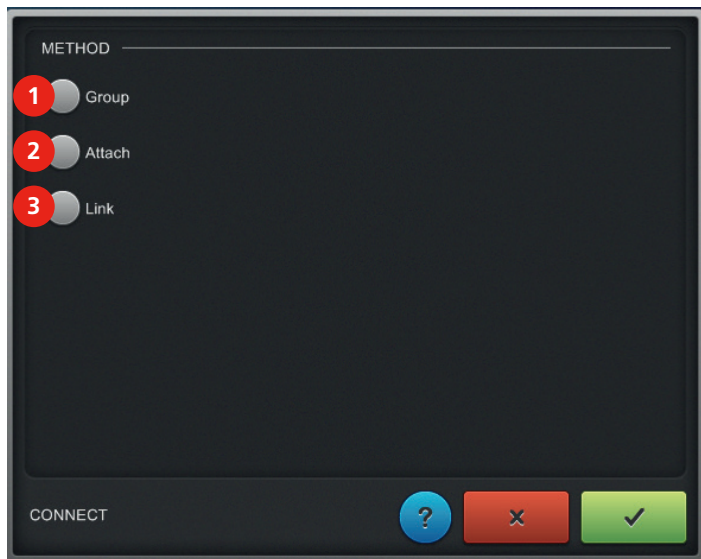

Separating quilt designs

Disconnects links which have been done by using the function «Linking quilt designs» (see page 67).

- > Activate the previously linked quilt design «Editing Display» with the finger.
- > Touch the lower icon «Unconnect» or

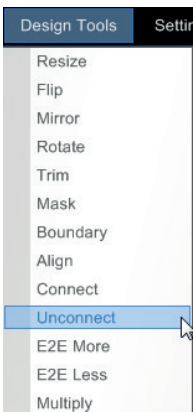

- > touch «Design Tools —> Unconnect» in the menu bar.
- The quilt designs are separated.

Aligning quilt designs in the «Editing Display»

A number of quilt designs can be aligned in different ways. As soon as the way of alignment is selected, the alignment line can be placed and it can be decided which quilt designs are to be aligned along this line.

Prerequisite:

- A number of quilt designs have been selected from the «Tool Center» and are visible in the «Editing Display».



- > Touch the icon «Select».
- > Activate any quilt design in the «Editing Display» with the finger.





> Touch the icon «Align» or

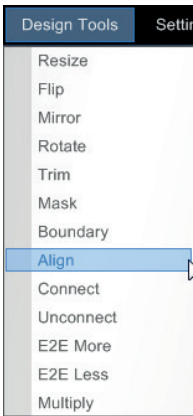

- > touch «Design Tools → Align» in the menu bar.
- > In section (2) select the desired alignment.
- > In section (1) Screen is selected so that the alignment line can be placed in the «Editing Display».
- > Touch the «Editing Display» with the finger.
 - A red alignment line appears.
- > Touch the «Editing Display» with the finger again to reposition the alignment line.
- > In section (3) select «Select Design».
- > In the «Editing Display» select a quilt design; the quilt design will be aligned along the line.
- > Select the next quilt design; it will also be aligned along the alignment line.

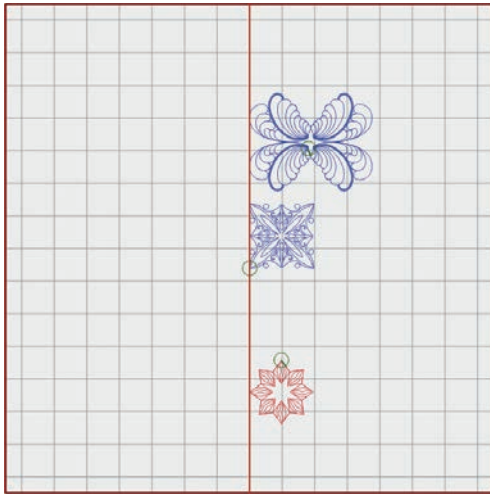

> Touch the icon «CLR» to delete the adjustments or



- > touch the icon «Confirm».
- The screen is closed and the previously made adjustments are saved.



Aligning quilt designs via the «Sewhead»

A number of quilt designs can be aligned in different ways. As soon as the way of alignment is selected, the alignment line can be placed and it can be decided which quilt designs are to be aligned along this line.

Prerequisite:

- A number of quilt designs have been selected from the «Tool Center» and are visible in the «Editing Display».



- > Touch the icon «Select».
- > Activate any quilt design in the «Editing Display».



- > Touch the icon «Align» or

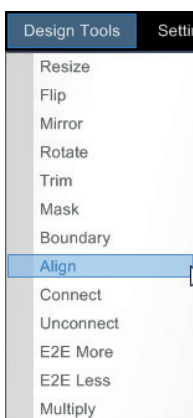

- > touch «Design Tools —> Align» in the menu bar.
- > In section (2) select the desired alignment.
- > In section (1) select «Sewhead» so that the alignment line can be placed via the «Sewhead».
- > Place an alignment line via the «Sewhead».
- > In the «Sewhead Display» touch the icon «Set» or any other handle button to confirm the alignment line.
 - An alignment line appears in the «Editing Display».
- > In section (3) select «Select Design».
- > In the «Editing Display» select a quilt design; the quilt design will be aligned along the line.
- > Select the next quilt design; it will also be aligned along the alignment line.

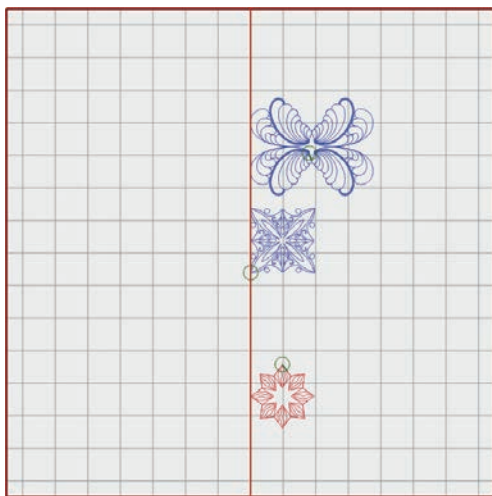

- > Touch the icon «CLR» to delete the adjustments or



- > touch the icon «Confirm».



> The screen is closed and the previously made adjustments are saved.



Altering the size of quilt designs in the «Editing Display»

The size of quilt designs can be altered proportionally and unproportionally.

Prerequisite:

- A quilt design has been selected from the «Tool Center» and is visible in the «Editing Display».



- > Touch the icon «Select».
- > Activate a quilt design in the «Editing Display» with the finger.



- > Touch the icon «Resize» or

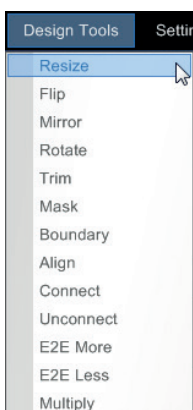

- > touch «Design Tools → Resize» in the menu bar.
 - The quilt design is given a grid with four points in the «Editing Display». The green point defines the direction how the quilt design will be changed.
- > The icon (1) needs to be selected.
 - The quilt design is given a grid with four points.
- > To define another resizing point, press one of the black points and keep pressed until the black point turns green.
 - At the new green point the size of the quilt design can be changed.

- > Press the green point of the quilt design and pull outwards or inwards to resize the quilt design proportionally.

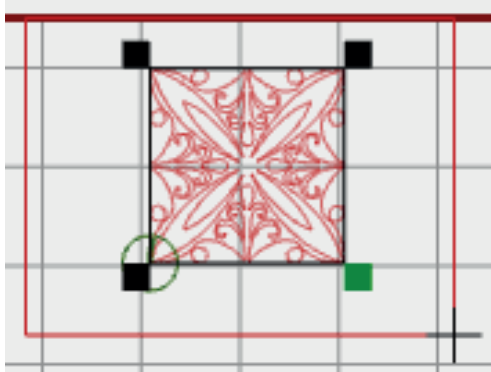

- Below the «Editing Display» on the right the width and the height of the quilt design is indicated (see page 24).
- > Touch the icon (2) to resize the quilt design unproportionally.
 - The quilt design is given a grid with eight points.

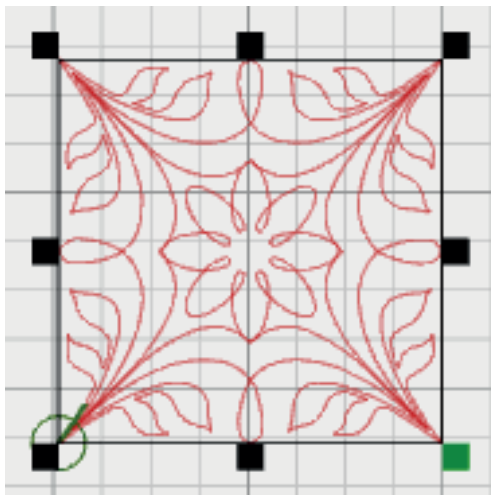

- > Press the green point and pull outwards or inwards to resize the quilt design unproportionally.
- > Touch the icon «CLR» to delete the adjustments or
 - > touch the icon «Confirm».
 - The screen is closed and the previously made adjustments are saved.





Altering the size of quilt designs via the «Sewhead»

The size of quilt designs can be altered proportionally and unproportionally.

Prerequisite:

- A quilt design is selected and visible in the «Editing Display».



- > Touch the icon «Select».
- > Activate a quilt design in the «Editing Display» with the finger.



- > Touch the icon «Resize» or

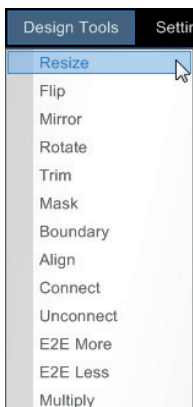

- > touch «Design Tools → Resize» in the menu bar.
 - The quilt design is given a grid with four points in the «Editing Display». The green point defines the direction how the quilt design will be changed.
- > To define another resizing point, press one of the black points and keep pressed until the black point turns green.
- > Touch the icon (1) to alter the size of the quilt design via the «Sewhead».
- > Move the «Sewhead» to the starting point on the quilt which must be diagonally opposite the green point.
- > In the «Sewhead Display» touch the icon «Set» or press any handle button.
 - The starting point is placed.
- > Move the «Sewhead» to the endpoint.
- > In the «Sewhead Display» touch the icon «Set» or press any handle button.
 - The endpoint is placed and the size of the quilt design is proportionally altered and visible in the «Editing Display». Below the «Editing Display» on the right the width and the height of the quilt design is indicated.
- > Touch the icon (2) to resize the quilt design unproportionally.
- > Place the starting point and the endpoint as described beforehand.
 - The size of the quilt design is altered unproportionally and visible in «Editing Display».



- > Touch the icon «Confirm».
- The screen is closed and the previously made adjustments are saved.



Altering the size of quilt designs via the enter keys

The size of quilt designs can be altered proportionally and unproportionally.

Prerequisite:

- A quilt design has been selected from the «Tool Center» and is visible in the «Editing Display».



- > Touch the icon «Select».
- > Activate a quilt design in the «Editing Display» with the finger.



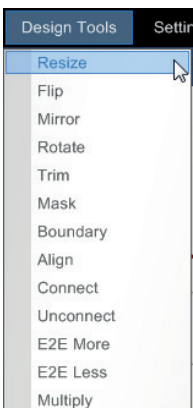

- > Touch the icon «Resize» or

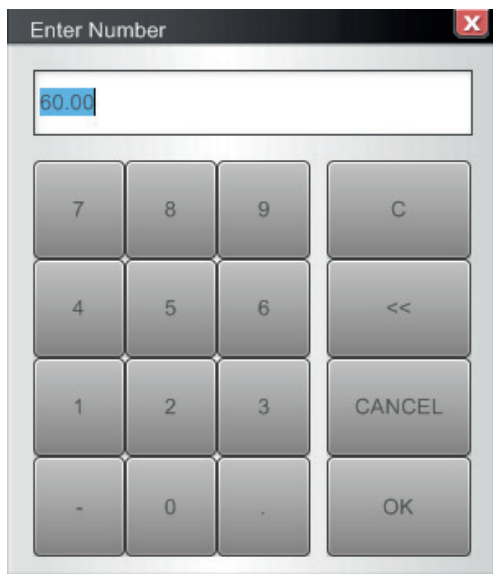

- > touch «Design Tools → Resize» in the menu bar.
- > Touch the icon (1).
- > Touch the icon (2) to enter the size of the quilt design via the enter keys.

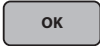
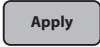

-  > Touch the icon «OK» to confirm the entry.
-  > Touch the icon «Apply» to confirm the entry again.
– The quilt design has been resized proportionally. Below the «Editing Display» on the right the width and the height of the quilt design is indicated.
- > Touch the icon (4) to resize the quilt design unproportionally.
- > Touch the icon (2) to enter the size of the height of the quilt design via the enter keys.
- > Touch the icon «OK» to confirm the entry.
- > Touch the icon (3) to enter the width of the quilt design via the enter keys.
- > Touch the icon «OK» to confirm the entry.
- > Touch the icon «Apply» to confirm the entry again.
– The quilt design has been resized unproportionally.
-  > Touch the icon «Confirm».
– The screen is closed and the previously made adjustments are saved.

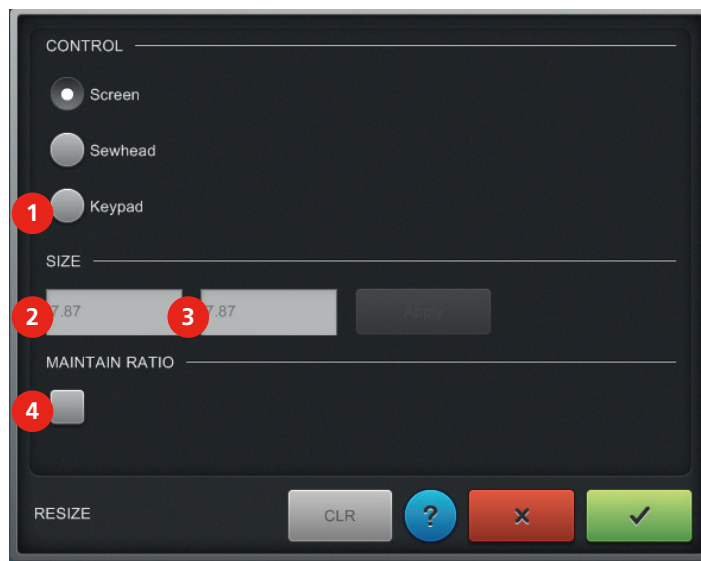

Transferring quilt designs to the program Art & Stitch

Together with the Q-matic system, the program Art & Stitch is also provided by BERNINA International AG. This program offers a wide range of options to alter and to digitalize already existing quilt designs. Please find further information and instruction manuals at <http://artandstitch.com> or directly in the program among the function or directly in the program using the function «Help». We recommend you to connect the supplied mouse when editing quilt designs in «Art & Stitch». Please do other elaborated work on a separate PC.

Prerequisite:

- The quilt design has been selected from the «Tool Center» and is visible in the «Editing Display».



- > Touch the icon «Select».



- > Touch the icon «Art & Stitch» to start the program.
– The quilt design appears in the display of «Art & Stitch» and can be edited as you like.

- > Before the data transfer takes place, assign «Running Stitches» first, and after that, touch the «Q-matic» icon.
 - When working with a very big design in Art & Stitch (e.g. design QE18) it can occur that the data transfer takes some minutes.

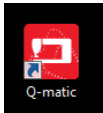
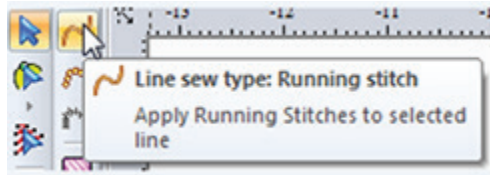

- > Touch the «Q-matic» icon to transfer the edited quilt design back to Q-matic.
 - A new screen is opened.
- > The edited quilt design must be saved in the format .ans in the folder «Documents» or in any self-created folder of your own choice.
- > Enter a name for the quilt design and save it.
 - The quilt design is saved in the format .ans as well as in the format .bqm. The quilt design appears in the «Editing Display» of the Q-matic.
- > Import the quilt design to the «Design Pool» (see page 77).

4.5 Administrating quilt projects and quilt designs

Within the administration it can be differed between quilt projects and quilt designs.

A quilt design is saved in the format .bqm and can be imported to the «Design Pool». A quilt project is saved in the format .bqp and can be opened at any time.

Saving a quilt project

Self-created quilt projects can be saved.

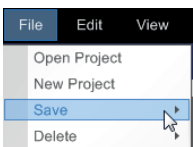

- > In the menu bar touch «File —> Save —> Save Project».
 - The explorer is opened. The project is automatically saved in the correct format .bqp and put into the correct folder «Projects» on the desktop.
- > Give the project a file name.
- > Touch the icon «Save».
 - The quilt project is saved.

Opening a quilt project

Saved quilt projects can be opened and altered.

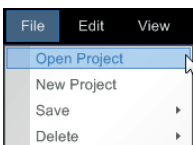

- > In the menu bar touch «File —> Open Project».
 - A new screen is opened.
- > Touch the icon «Yes» to save the already opened project first.
 - The explorer is opened. The project is saved automatically in the correct format .bqp and put into the correct folder «Project».
- > Give the project a file name.
- > Touch the icon «Save».
 - The explorer is opened and the quilt project is saved.
- > Open the desired data medium in the explorer.
- > Select the desired project in the format .bqp.
 - The selected quilt project is opened.



Creating a new quilt project

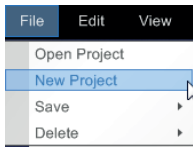

- > In the menu bar touch «File → New Project».
 - A new screen is opened.
- > Touch the icon «Yes» to save the already opened project first.
 - The explorer is opened. The project is saved automatically in the correct format .bqp and put into the correct folder «Project».
- > Give the project a file name.
- > Touch the icon «Save».
 - The quilt project is saved and a new editing area is opened.

Saving quilt designs

Self-created or altered quilt designs can be saved.

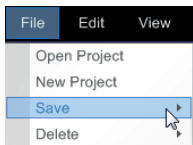

- > In the menu bar touch «File → Save → Save Design File».
 - The explorer is opened. The project is saved automatically in the correct format .bqp and put into the correct folder «Designs» on the desktop.
- > Change the filename of the quilt design.
- > Touch the icon «Save».
 - The quilt design is saved.
- > The quilt design can be imported to the «Design Pool» (see page 77).

Saving quilt designs on the BERNINA USB stick

Quilt designs can be edited in the program «Art and Stitch» on another computer (PC).

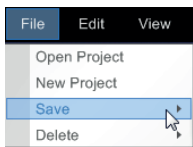

- > Insert the BERNINA USB stick into the USB port on the right of the PC/Monitor.
- > In the menu bar touch «File → Save → Save Design File».
 - The explorer is opened.
- > In the explorer, select the BERNINA USB stick.
- > Change the filename of the quilt design.
- > Touch the icon «Save».
 - The quilt design will be saved on the BERNINA USB stick.

Importing quilt designs

Only quilt designs in the formats .bqm and .dxf can be imported.

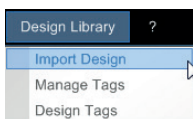

- > In the menu bar touch «Design Library → Import Design».
- > Select the folder in the «Explorer» where the quilt designs are saved.
- > Touch the desired quilt design to see the quilt design in the display «Files».
- > In the display «Files» touch the desired quilt design to see it as preview in the display «Design Preview».
- > In the display «Files» touch the desired quilt design twice in short succession to see the quilt design in the display «Importing».
- > Allocate the wanted tags to the quilt design (see page 82).
- > Touch the icon «Import» to import the quilt design to the «Design Pool» or

Import

CLR

Select All

- > touch the icon «Clear» to delete all quilt designs or
- > touch a quilt design twice in short succession to delete it.
- > Touch the icon «Select all» to select all.
 - All quilt designs are copied to the section «Importing».

Import

> Touch the icon «Import».

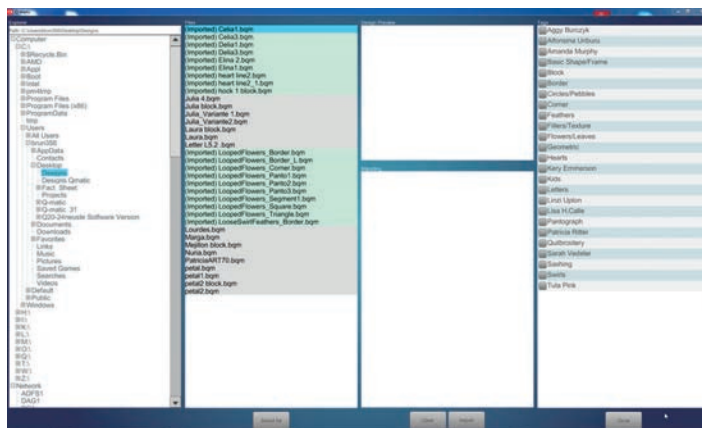

– The name of the quilt design is indicated in the display «Files» with the supplement «Imported».

Close

> Touch the icon «Close».

– The quilt designs are visible in the «Design Center».

Importing quilt designs from the BERNINA USB stick

Only quilt designs in the formats .bqm and .dxf can be imported.

> Insert the BERNINA USB stick into the USB port on the right of the PC/Monitor.

> In the menu bar touch «Design Library —> Import Design».

> Select the USB stick in the «Explorer».

> Touch the desired quilt design to see the quilt design in the display «Files».

> In the display «Files» touch the desired quilt design to see it as preview in the display «Design Preview».

> In the display «Files» touch the desired quilt design twice in short succession to see the quilt design in the display «Importing».

> Allocate the wanted tags to the quilt design (see page 82).

> Touch the icon «Import» to import the quilt design to the «Design Pool» or

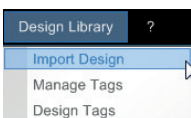

Import

CLR

Select All

Import

> touch the icon «Clear» to delete all quilt designs or

> touch a quilt design twice in short succession to delete it.

> Touch the icon «Select all» to select all.

– All quilt designs are copied to the section «Importing».

> Touch the icon «Import».

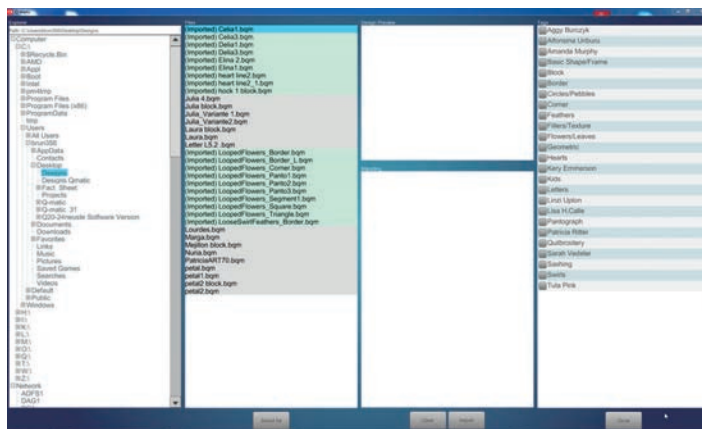

– The name of the quilt design is indicated in the display «Files» with the supplement «Imported».

Close

> Touch the icon «Close».

– The quilt designs are visible in the «Design Center».

Deleting quilt designs from the «Design Center»

Deleting single or all quilt designs from the «Design Center».



- > Touch the icon «Add Design» to remove quilt designs from the «Design Center» (1).
- > In section «Design Center» (1) touch a quilt design twice in short succession to delete it.



- > Touch the icon «Clear All» to delete all quilt designs from «Design Center».
- > Touch the icon «Close» (2).

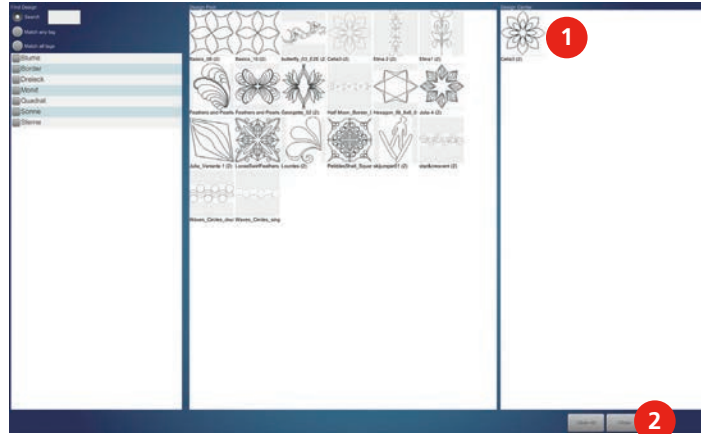

- The quilt design is not visible in the «Design Center» anymore.

Deleting quilt designs from the «Design Pool»

Deleting particular quilt designs from the «Design Pool».

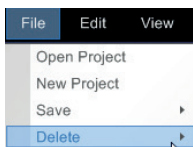

- > In the menu bar touch «File —> Delete —> Design File».
 - A new screen is opened.
- > Touch the desired quilt designs which are to be deleted.
 - The selected quilt designs are highlighted.

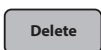
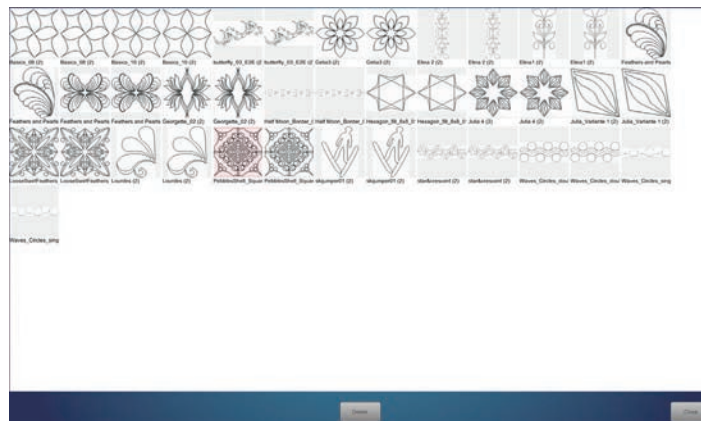

- > Touch the icon «Delete».
- > Touch the icon «Yes» or «No» to delete the quilt designs or to cancel.
- > Touch the icon «Close».



Deleting quilt projects

Self-created quilt projects can be deleted.

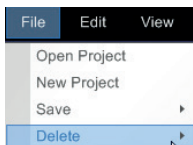

- > In the menu bar touch «File —> Delete—> Delete project».
 - A new screen is opened.
- > In section (1) activate the quilt project which is to be deleted.
 - Das The selected quilt project is highlighted in blue.

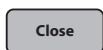

- > Touch the icon «Delete».
- > Touch the icon «Yes» or «No» to delete the quilt project or to cancel the process.
- > Touch the icon «Close» to save the adjustment.

Creating tags

Tags for quilt designs can be created e.g. after designers, shapes and kind etc. This facilitates the search for appropriate quilt designs.

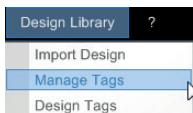

- > In the menu bar touch «Design Library —> Manage Tags».
 - The screen «Manage Tags» is opened.
- > Touch the icon «Add» (1).

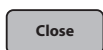
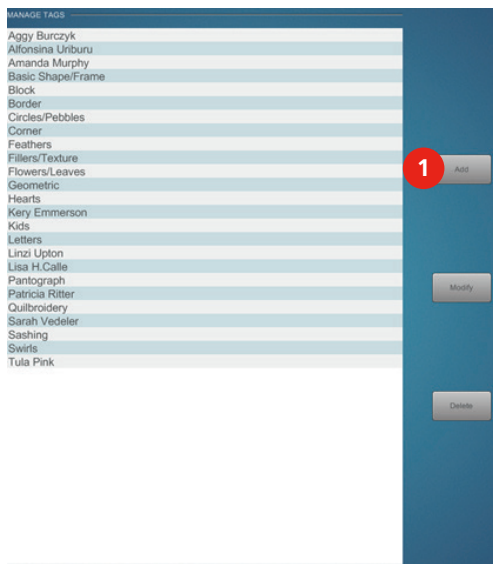

- > Enter the tag via the keypad.
- > Touch the icon «Confirm».
 - The screen is closed and the previously made adjustments are saved.
- > Touch the icon «Close» to save the adjustment.

Altering tags

Altering tags for quilt designs.



- > In the menu bar touch «Design Library —> Manage Tags».
 - The screen «Manage Tags» is opened.
- > Select the desired tag which is to be altered.
- > Touch the icon «Modify» (1).

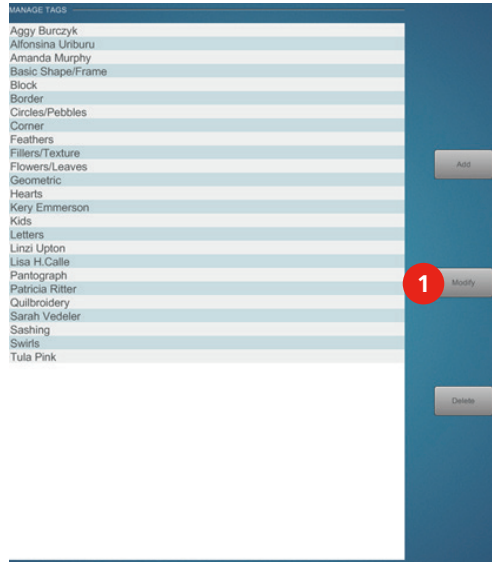

- > Alter the tag via the keypad.
- > Feld «Confirm» drücken.
 - The screen is closed and the previously made adjustments are saved.
- > Touch the icon «Close» to save the adjustment.



Deleting tags

Deleting tags of quilt designs.

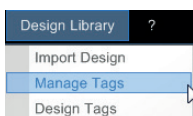

- > In the menu bar touch «Design Library —> Manage Tags».
 - The screen «Manage Tags» is opened.
- > Select the desired tag which is to be deleted.

> Touch the icon «Delete» (1) to delete the tag.

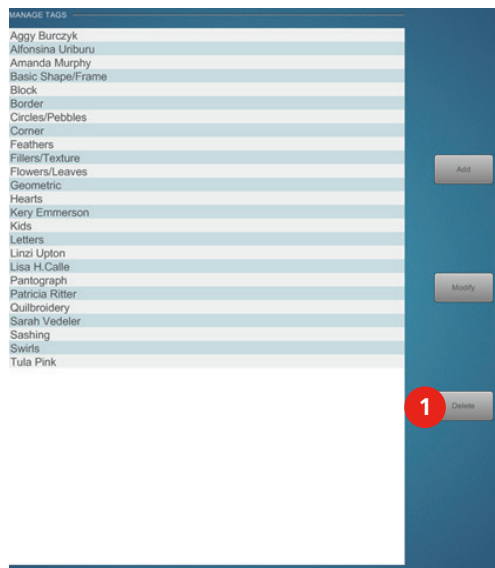

> Touch the icon «Close» to save the adjustment.

Allocating tags to a quilt design

Allocating tags to a quilt design. This facilitates the search for a suitable quilt design.



> In the menu bar touch «Design Library —> Design Tags».

– A new screen is opened.

> In the display «Design Pool» (1) touch the desired quilt design twice in short succession.

– The quilt design appears in the display «Selected Designs» (2).

– The selected quilt design is highlighted in gray in the display «Design Pool» (1).

– All tags are indicated in the display «Tags» (3). The tag which has already been allocated to the quilt design is checked.

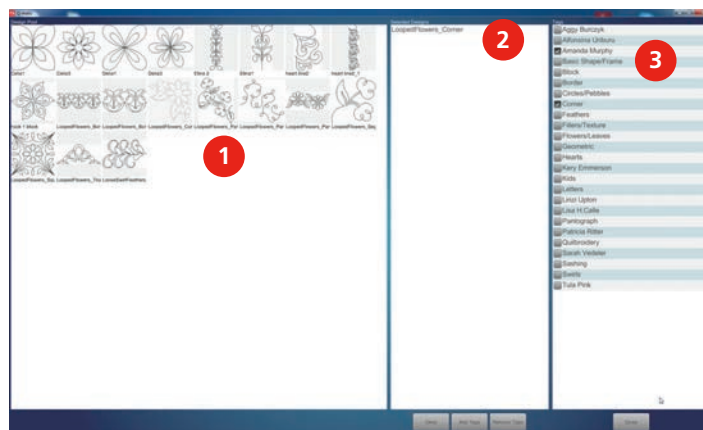

> Touch further tags in the display «Tags» to allocate them to the quilt design.



> Touch the icon «Add Tags» and confirm by touching the icon «OK».

– All checked tags have been allocated to this quilt design.



> Touch the icon «Clear» or the quilt design twice in short succession to delete it from the «Selected Designs» (2).

> Allocate more tags to the particular quilt designs or

> touch the icon «Close» to save the alterations.



Allocating tags to several quilt designs

Allocating the same tags to several quilt designs. This facilitates the search for the suitable quilt designs.

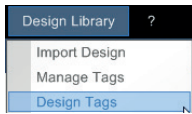

- > In the menu bar touch «Design Library —> Design Tags».
 - A new screen is opened.
- > In the display «Design Pool» (1) touch all desired quilt designs twice in short succession to which the same tags are to be allocated.
 - They appear in the display «Selected Designs» (2).
 - The selected quilt designs are highlighted in gray in the display «Design Pool» (1).
 - All tags are indicated in the display «Tags» (3). All tags which have already been allocated to the quilt designs are checked.

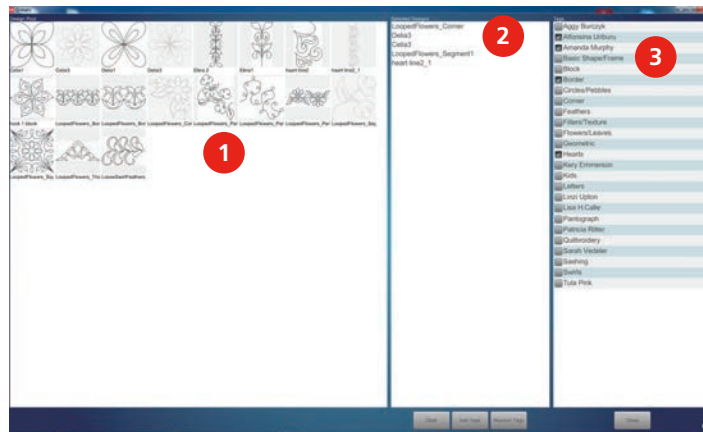

- > Remove all check marks from the tags.
- > Touch further tags in the display «Tags» to allocate them to the quilt designs.
- > Touch the icon «Add Tags» and confirm by touching the icon «OK».
 - All checked tags have been allocated to all quilt designs.
- > Touch the icon «Clear» to delete all quilt designs from the display «Selected Designs».
- > Allocate the tags to further quilt designs or
- > touch the icon «Close» to save the alterations.

Add Tags

Clear

Close

Removing tags from one quilt design

Removing tags from one quilt design.

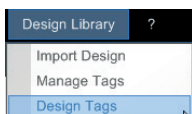

- > In the menu bar touch «Design Library —> Design Tags».
 - A new screen is opened.

- > In the display «Design Pool» (1) touch the desired quilt design twice in short succession so that it appears in the display «Selected Designs» (2).
 - The selected quilt design is highlighted in gray in the display «Design Pool» (1).
 - All tags are indicated in the display «Tags» (3). All tags which have already been allocated are checked.

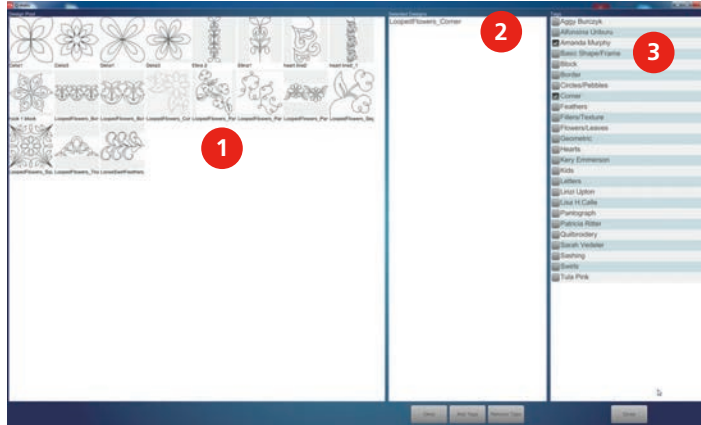

- > Remove all check marks from the tags, which are **not** to be deleted.
- > Touch the icon «Remove Tags» and confirm by touching the icon «OK».
 - All checked tags have been removed from this quilt design.



- > Touch the icon «Clear» or the quilt design twice in short succession to delete it from the display «Selected Designs».
- > Remove tags from other single quilt designs or
- > touch the icon «Close» to save the alterations.

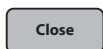

Removing tags from several quilt designs

Removing tags from several quilt designs.

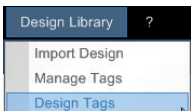

- > In the menu bar touch «Design Library--> Design Tags».
 - A new screen is opened.
- > In the display «Design Pool» (1) touch all the desired quilt designs where the same tags are to be removed twice in short succession. They appear in the display «Selected Designs» (2).
 - The selected quilt design is highlighted in gray in the display «Design Pool» (1).
 - All tags are indicated in the display «Tags» (3). All tags which have already been allocated are checked.

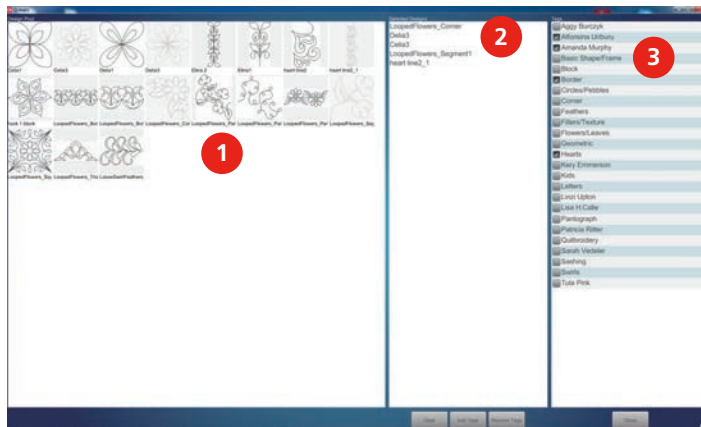

- > Remove all check marks from the tags which are **not** to be deleted.

Remove Tags

- > Touch «Remove Tags» and confirm by touching the icon «OK».
 - All checked tags have been removed from these quilt designs.

Clear

- > Touch the icon «Clear» to delete all quilt designs from the display «Selected Designs».
- > Remove tags of further quilt designs or

Close

- > touch the icon «Close» to save alterations.



5 Quilting

5.1 Sewing quilt designs

All active quilt designs in the «Safe Area» can be sewn out. The quilting process can be interrupted or canceled at any time.

Prerequisite:

- In the «Settings» securing on/off must be activated.
- The quilt design has been selected and is visible in the «Editing Display».



- > Touch the icon «Select».
- > Activate the quilt design in the «Editing Display» with the finger.



- > Touch the icon «Start» to start sewing.
 - A new screen is opened in the «Sewhead Display».



- > Touch the icon «Confirm».
- The screen is closed and the machine travels to the starting point.



- > Touch the icon «Securing» at the «Sewhead» or press the handle buttons I to sew a complete stitch or
- > touch the icon «Securing» at the «Sewhead» or keep the handle buttons I pressed to sew the preprogrammed securing stitches.



- > Touch the icon «Needle up/down» at the «Sewhead» or press the handle buttons II, so that the needle is lowered.
- > Touch the icon «Needle up/down» at the «Sewhead» or press the handle buttons II again, so that the needle is raised.



- > Touch the icon «Confirm».
- The screen is closed and the machine sews the quilt design.

5.2 Interrupting the sewing process of quilt designs

Sewing can be interrupted either via the «Sewhead» or the PC/Monitor. If the sewing is interrupted, the thread tension and the SPI (stitches per inch) can be adjusted.

Prerequisite:

- The quilt design is being sewn.



- > Touch the icon «Break» to interrupt sewing.
 - In the «Sewhead Display» a new screen appears to adjust the thread tension or the SPI (stitches per inch).
- > In section (1) alter the SPI via the icons «-» and «+».
- > In section (2) adjust the thread tension via the icons «-» and «+».

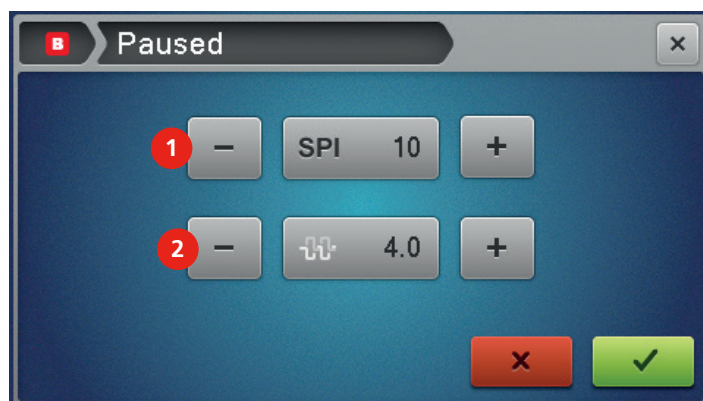

- > Touch the icon «Confirm».
 - Sewing is continued.

5.3 Interrupting the sewing process of a quilt design after a thread breakage



After a thread breakage or when the bobbin is empty with activated bobbin thread indicator (refer to instruction manual Q 20 / Q 24), the machine stops automatically.

After a thread breakage, the needle can be repositioned either at the stop point or at any other point of the quilt design with the help of the Thread Break Recovery.

Prerequisite:

- In the menu bar under «Settings» the «Securing on/off» must be activated.
- The quilt design is being sewn.



- > Touch the icon Stop to stop sewing e.g. after a thread breakage or when the bobbin is empty..



- > Touch the icon «Start».
 - A new screen is opened.



- > Touch the icon «Confirm».
 - > Move the «Sewhead» to the desired point of the interruption to resume sewing from there.



- > Touch the icon «At closest Point on design».
 - A new screen is opened in the «Sewhead Display». Find further information about this topic«» (see page 86).

> or



- > Touch the icon Stop to stop sewing e.g. after a thread breakage or when the bobbin is empty..



- > Touch the icon «Start».
 - A new screen is opened.



- > Touch the icon «Confirm».



- > Touch the icon «At Stop Point».
 - The machine resumes sewing at that position where it has stopped.

6 Attachment

6.1 Cleaning the display

- > Clean the display when it is switched off with a soft slightly damp microfiber cloth.

6.2 Cleaning the energy chain and the X-Y-belts

It must be ensured that the energy chain and the X-Y-belts are free from thread remnants and lint.

Please find further information about «Checking and cleaning the carriage» in the instruction manual «BERNINA Q 20 / Q24».



6.3 Troubleshooting

Fault	Cause	Repair
The machine doesn't start.	The red emergency stop knob is still pressed.	> Turn the red emergency stop knob in arrow direction so that the emergency stop knob is in the correct position.
The «Safe Area» cannot be defined.	The clutch of the X- and Y- belt clamps are unlocked.	> Make sure that the clutch of the X- and Y- belt clamps are locked.
The quilt design is not sewn out correctly.	The quilt design is only sewn in the Y- or X- axis.	> Make sure that the clutch of the X- and Y- belt clamps are locked.
Too less free capacity on the BERNINA USB stick.	Not enough free capacity available on the BERNINA USB stick.	> Make sure that the BERNINA USB stick is used. > Delete data from the BERNINA USB stick.
No BERNINA USB stick is inserted. Make sure that during the complete automatic update always the same BERNINA USB stick remains inserted.	The BERNINA USB stick is not inserted.	> Use a BERNINA USB stick providing enough free capacity.
The machine doesn't start.	LEDs light up or flash at the control cabinet or the X-Y-drives after the starting process.	> Further information (see page 31).
After pushing the Sewhead the machine runs on its own.	Easy Glide setting of the machine is set too high.	Change Easy Glide setting. (see page 37).

6.4 Error messages Q-matic software

Message on the display	Cause	Repair
The system has reported a fault: A thread break fault has occurred.	The upper thread is used up.	> Rethread. Start the machine touching «Play», (see page 87).
	The upper thread has broken.	
The system has reported a fault: A thread break fault has occurred.	The bobbin thread is used up.	> Rethread. Start the machine touching «Play», (see page 87).
	The bobbin thread has broken.	> Clean the hook. > Rethread. Start the machine touching «Play», (see page 87).
The system has reported a fault: There is a problem with the machine. Please check the sewhead.	The machine is not switched on.	> Switch the machine on.
	The connection cable to the Q-matic system is not plugged in.	> Plug in the cable.
A design is partially outside of the safe area or there are no queued designs in the safe area.	The quilt design can't be sewn out.	> Reposition the quilt design in the «Safe Area» or redefine the «Safe Area». > Move the quilt design back to the waiting line (see page 47).
The system has reported a fault: The controller has lost communication with the motor drives. Please ensure the STOP-button is not pressed.	The motor drive doesn't work. At the X-Y-drive both or only one of the LED control lamps light up in «orange».	> Make sure that the plugs of both cables are plugged in correctly and that they are not defect. > Both LED control lamps must light up in «green». > The «Safe Area» must be redefined. > Restart the machine by touching Play.
The system has reported a fault: A X-axis has fault occurred. The controller has lost communication with the motor drives. Please ensure the STOP-button is not pressed.	The controlling of the X-Y-drive doesn't work. At the X-Y-drive both or only one of the LED control lamps light up in «orange».	> Make sure that the plugs of both cables are plugged in correctly and that they are not defect. > Both LED control lamps must light up in «green». > The «Safe Area» must be redefined. > Restart the machine by touching Play.
The system has reported a fault: A needle fault has occurred.	Moving the handwheel while positioning the «Sewhead».	> The Q-matic system needs to be restarted.
The sewhead is too far away from any design. Please reposition the sewhead then click Start.	The «Sewhead» is too far away from the quilt design.	> Move the «Sewhead» closer to the quilt design.
The system has reported a fault: A sequence fault has occurred.	The machine is not switched on. The machine has an old firmware version.	> Switch the machine on. > Update the machine with the latest firmware.
The system has reported a fault: Unable to sew because designs are too large.	The design is too large. The created design is too long (length or number of stitches) and cannot be proceeded.	Reduce the design size of linked or multiplied designs via «Unlink» or split the design into smaller parts in Art & Stitch.

6.5 Overview quilt designs

Tips around the quilt designs

The implemented quilt designs have been digitalized very exactly as for their geometry. Therefore the Q-matic system sews them out exactly and accurately. Nevertheless, inaccuracy can be visible especially with large designs. The reasons for this are: The deformation of the fabric layers during the quilting process.

Actions to minimize deformation

- Before quilting is started, fix the quilt block and the quilt sandwich with basting stitches first.
- As for quilt designs with an outline or a frame, always sew the outer areas first before sewing the inner areas.
- Stretch the quilt top as well as the backside fabric properly; don't let the fabric float.
- Stretch the backside fabric sideways by the help of side clamps. Do never change this stretching while quilting.
- Neither lean against the front bar nor support the arms on it.
- After extreme enlargements or reductions, always sew out a quilt test.







Jump Stitch







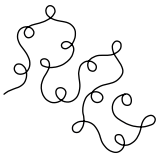





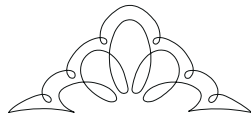
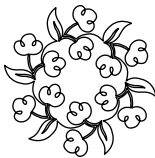

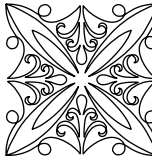

A «Jump Stitch » means that while quilting a design, the needle has to change from one position to another, before the quilting process can be continued. There is a gap (jump) between the previous and the following stitch. This jump is done by the machine without adding any stitches in between. The user can decide whether the machine should stop at the position of the jump stitches to secure the thread or whether the machine should continue at these jumps without a stop and therefore without this immediate securing option. Designs with «jump stitches» have indicated the number of «jump stitches» in the following overview below its name («Jump stitches: »x).





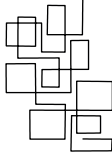





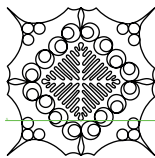

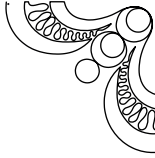
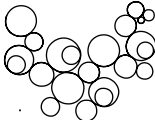



Included quilt designs





To find more information about the famous designers and quilters that created the designs included in BERNINA Q-matic please search for the people by name in the world wide web and visit their webpages or blogs. Q-matic includes Designs from Lisa H. Calle, Keryn Emmerson, Amanda Murphy, Tula Pink, Patricia Ritter, Linzi Upton, Alfonsina Uriburu, Sarah Vedeler etc.

Amanda Murphy











Name	Quilt design	Name	Quilt design
LoopedFlowers_ Border		LoopedFlowers_ Border_L	
LoopedFlowers_ Corner		LoopedFlowers_ Panto1	
LoopedFlowers_ Panto2		LoopedFlowers_ Panto3	





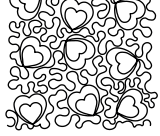

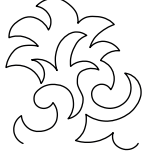







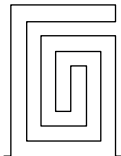
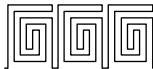

Name	Quilt design	Name	Quilt design
LoopedFlowers_Segment		LoopedFlowers_Square	
LoopedFlowers_Triangle		LoopedFlowers_Wreath	
LooseSwirlFeathers_Border		LooseSwirlFeathers_Corner	
LooseSwirlFeathers_Panto		LooseSwirlFeathers_Segment	
LooseSwirlFeathers_Square		LooseSwirlFeathers_Triangle	
Panto_Candle		Panto_Hearts1* *Only results in a Pantograph with the quilt design «Panto_Hearts2»	
Panto_Hearts2* *Only results in a Pantograph with the quilt design «Panto_Hearts1»		Panto_LooseSwirls	
Panto_Square Meander		Panto_Stars	
Panto_SwirlFlower		Panto_Swirls	

Name	Quilt design	Name	Quilt design
PebblesShell_Square Jump stitch: 1		PebblesShells_Border	
PebblesShells_Corner		PebblesShells_Panto	
PebblesShells_Segment		PebblesShells_Triangle	
PebblesShells_Wreath		SwirlsPaisley_Border	
SwirlsPaisley_Corner		SwirlsPaisley_Panto	
SwirlsPaisley_Segment		SwirlsPaisley_Square1	
SwirlsPaisley_Square2		SwirlsPaisley_Triangle	
SwirlsPaisley_Wreath		TightSwirls_Continuous	
VinesBerries_Block		VinesBerries_Border	





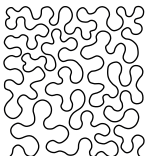









Name	Quilt design	Name	Quilt design
VinesBerries_Border2		VinesBerries_Corner	
VinesBerries_Panto		VinesBerries_Triangle	
VinesBerries_Wreath			





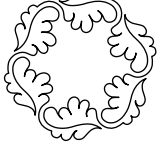
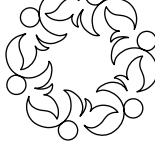
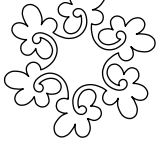
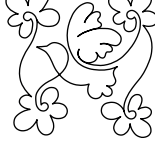













Keryn Emmerson

Name	Quilt design	Name	Quilt design
Bellflower		Bellflower2	
Bramble		Bramble2	
Camelia		Camelia2	
Cherish		Cherish2	
China grove		China grove2	

Name	Quilt design	Name	Quilt design
China sea		China sea2	
Cottontop		Cottontop2	
Leafarama		Leafarama2	
Offkilter		Offkilter2	
Scrap paper		Scrap paper2	
Smoke		Smoke2	
Star & crescent		Star & crescent2	
Streamer		Streamer2	
Tangle		Villette	
Villette2			

Patricia Ritter





Name	Quilt design	Name	Quilt design
Aloha Block Petite Corner_PR053		Aloha Block1_PR009	
Aloha Block2_PR010		Aloha Petite_ PRPANTO10	
Aloha Sashings_ PRPANTO35		Aralia	
Leaf Sashing1		Morning Glory	
PR007		PR011	
PR012		PR016	
PR082		PR0125	
PR126		PR127	
PR128		PRPANTO01	

Name	Quilt design	Name	Quilt design
PRPANTO21		PRPANTO47	
PRPANTO64		PRPANTO65	
PRPANTO68		PRPANTO68_gross	
PRPANTO83		PRPANTO100	
PRPANTO110		PRPANTO131	
PRPANTO145		PRPANTO150	
PRPANTO151		PRPANTO152	
PRPANTO189		PRPANTO321	
PRPANTO489		Rebekah's rose	



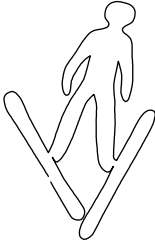
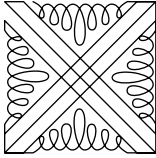
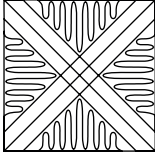



Aggy Burczyk



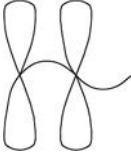

Name	Quilt design	Name	Quilt design
Ayana_basic		Ayana_block_01	
Ayana_block_02		Ayana_block_03	
Ball_01		Bellini_01	
Bellini_02		Butterfly_01	
Butterfly_01_E2E		Butterfly_02	
Butterfly_03_E2E		Circles	
Denebola		Feathers and Pearls_01	
Feathers and Pearls_02		Georgette_01	
Jump stitches: 3			



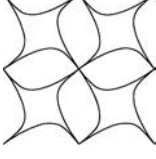

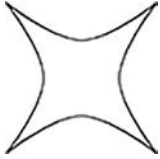
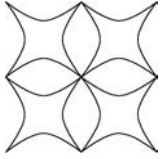
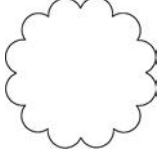
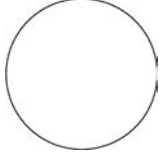
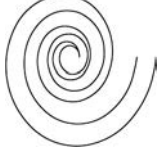
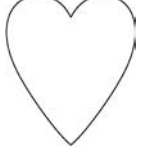
Name	Quilt design	Name	Quilt design
Georgette_02		Half Moon_Border_01	
Half Moon_Border_02		Half Moon_Border_03	
Half Moon_Border_03_XS Jump stitches: 3		Hexagon_fill_01	
Hexagon_fill_02		Hexagon_fill_03	
Hexagon_fill_04		Hexagon_fill_05	
Pearls on a string		Pearls on a string_heart	
Pearls on a string_ring		Pearls_basic	

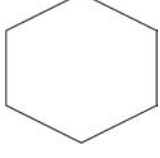
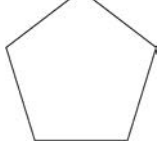
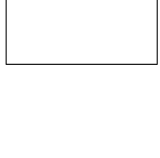
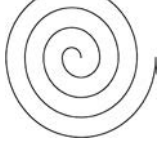
Name	Quilt design	Name	Quilt design
Skijumper		Square_fill_01	
Square_fill_02		Swirl_01	
Waves_Circles_double		Waves_Circles_single	

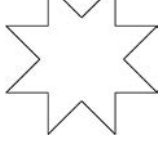



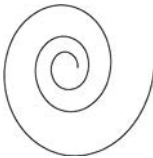
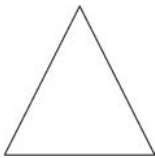

Basic Shapes by AB

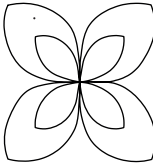
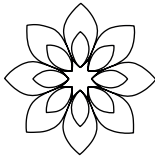
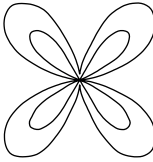
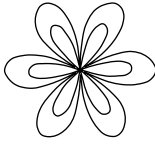

Name	Quilt design	Name	Quilt design
Basics_01		Basics_02	
Basics_03		Basics_04	
Basics_05		Basics_06	
Basics_07		Basics_08	

Name	Quilt design	Name	Quilt design
Basics_09		Basics_10	
Cake		Circle	
Double_Swirl_3		Heart_01	
Heart_02		Hexagon	
Pentagon		Rectangle_ASS	
Spiral_4		Spiral_6	
Square		Star_01	



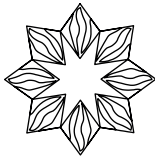

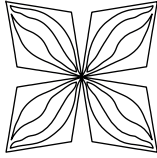
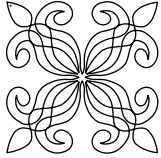
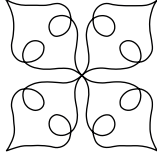
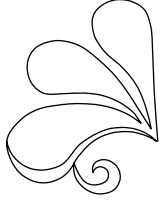
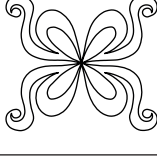
Name	Quilt design	Name	Quilt design
Star_02		Swirl_basic	
Swirl_3		Triangle	
Waves_basic			

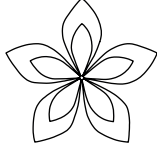
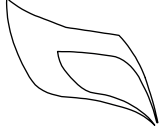
Alfonsina Uriburu



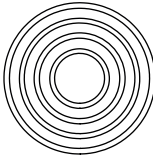
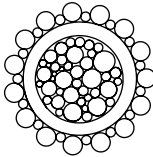
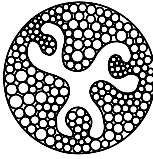
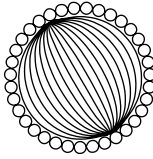

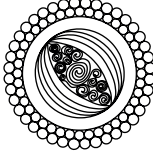
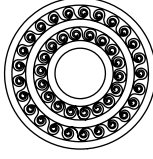

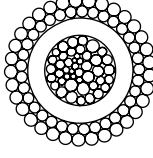

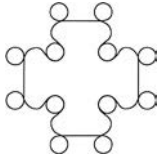
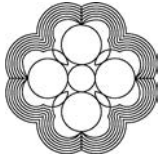

Name	Quilt design	Name	Quilt design
Celia1		Celia3	
Delia1		Delia3	
Elina1		Elina2	
Heart line		Heart line2_1	
Hock block		Julia	



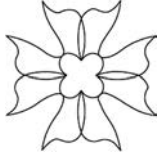

Name	Quilt design	Name	Quilt design
Julia block		Laura Block	
Lilli		Lourdes	
Mejillon block		Patricia	
Petal		Petal element	

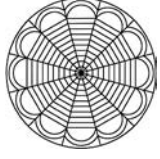
Linzi Upton

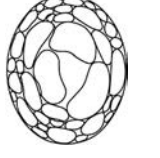
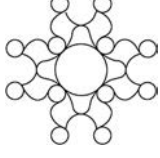

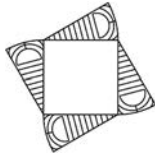
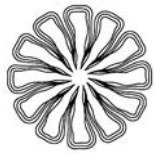

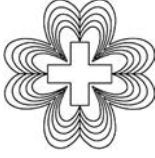





Name	Quilt design	Name	Quilt design
QE1 Jump stitches: 7		QE5 Jump stitch: 1	
QE9		QE10	
QE11		QE12	
QE13 Jump stitches: 1		QE18 Jump stitches: 3	
QE19 Jump stitches: 4		QE23 Jump stitch: 1	

Gerda Raschle

Name	Quilt design	Name	Quilt design
Ball_Block		Circle_Flower	
Dog-foot		Fantasy	
Feet		Feet_1	
Fingerprint		Flower_evergreen_02	
Flower_evergreen_01		Hands	
Mandala		no	
Ovale_Stone		Pebbles Square	

Name	Quilt design	Name	Quilt design
Pictures Frame		Rosa	
Row of houses		Swiss _Flower	
Yes			

Lisa Calle

Name	Quilt design	Name	Quilt design
LC 13 Swan's Journey Block 2		LC 13V1 Swan's Journey Block 2A Jump stitches: 5	
LC 13V2 Swan's Journey Block 1 Jump stitches: 7		LC 14 Swan's Journey Corner Large Jump stitch: 1	
LC 15 Swan's Journey Corner Sm Jump stitch: 1		LC 16 Swan's Journey Frame	
LCPANTO24 Swan's Journey BDR		LCPANTO25 Swan's Journey Panto LG	
LCPANTO26 Swan's Journey Small		LCPANTO27 Swan's Journey Sash	

Tula Pink and Sarah Vedeler

Coming soon.

A

Activating/Deactivating securing	36
Adapting the view of the quilt design to the size of the display	42
Aligning quilt designs in the «Editing Display»	68
Aligning quilt designs via the «Sewhead»	70
Allocating tags to a quilt design	82
Allocating tags to several quilt designs	83
Altering tags	81, 81
Altering the size of quilt designs in the «Editing Display»	71
Altering the size of quilt designs via the «Sewhead»	73
Altering the size of quilt designs via the enter keys	74

C

Calling up the Help	40
Changing the 1:1 view of the quilt design	42
Changing the Easy Glide settings of the machine	37
Changing the sewing direction	48
Cleaning the energy chain and the X-Y-belts	88
Connecting and switching on the Frame machine	31
Connecting quilt designs	67
Copying quilt designs	41
Creating a new quilt project	77
Creating tags	80
Creating the safe area	34

D

Defining a boundary	56
Defining a boundary in the «Editing Display»	58
Defining a boundary via the «Sewhead»	56
Defining the sewing sequence	47
Deleting quilt designs	41
Deleting quilt designs from the «Design Center»	38, 79
Deleting quilt designs from the «Design Pool»	79
Deleting quilt projects	80
Deleting tags	81
Delivery content Art & Stitch	27
Delivery content Q-matic system	27
Duplicating quilt designs (E2E)	64

E

Introduction	19
Entering the size of the quilt top	43
Error messages Q-matic software	90

G

Grab and drop	46
Grid on/off	36

I

Importing quilt designs	77
Importing quilt designs from the BERNINA USB stick	78
Interrupting the sewing process of a quilt design after a thread breakage	87
Interrupting the sewing process of quilt designs	86

J

Jump Stitch	91
-------------	----

K

Key to signs	20
--------------	----

M

Maintenance and Cleaning	88
Masking quilt designs using «Create Region» in the «Editing Display»	55
Masking quilt designs using «Create Region» via the «Sewhead»	53
Masking quilt designs using «Design»	51
Mirroring quilt designs	50
Moving quilt designs	40
Mutiple duplication of quilt designs	65

O

Opening a quilt project	76
Overview quilt designs	91
Overview Display	24
Overview front	22
Overview functions and visual display	24
Overview icons	26
Overview lower Tool Center	25
Overview side	23
Overview upper Tool Center	25

P

Placing and deleting markers	44
Pressing the emergency stop knob	34
Put quilt patterns in a waiting queue or remove it.	47

R

Realigning the safe area at the reference point	45
Realigning the safe area in the «Editing Display»	44
Reinstalling or Update of the Art & Stitch Software	28
Reinstalling or Update of the Q-matic software/firmware	28
Reinstalling Windows	28
Removing tags from one quilt design	83
Removing tags from several quilt designs	84
Replacing the All-in-One Touch PC	27
Restarting the system after a case of emergency	34
Rotating quilt designs	49

S

Saving a quilt project	76
Saving quilt designs	77
Saving quilt designs and tags on a BERNINA USB Stick	30
Saving quilt designs on the BERNINA USB stick	77
Searching quilt designs	39
Selecting a quilt design	38
Separating quilt designs	68
Sewing on/off	36
Sewing quilt designs	86
Signals on/off	36
Starting and switching off the Q-matic	33
Störungsbehebung	89

T

The needle is centered in the «Editing Display»	36
Trimming quilt designs in the «Editing Display»	62
Trimming quilt designs via the «Sewhead»	60

U

Update Q-Series firmware	29
Use of the Internet	27

W

Welcome to the world of BERNINA	19
---------------------------------	----

Z

Zooming in the view of the quilt design at the desired position	41
Zooming the view of the quilt design in or out	42

