

Capella™

Embroidery Design Guide Guide de motifs de broderie

Model BMCAP



FOR THE LOVE OF SEWING

To register your machine warranty and receive Baby Lock product updates and offers, go to babylock.com/profile. If you have questions with registration, visit your Authorized Baby Lock Retailer.

Pour enregistrer la garantie de votre machine et recevoir les mises à jour et les offres des produits Baby Lock, rendez-vous sur babylock.com/profile. Si vous avez des questions concernant l'inscription, rendez-vous chez votre Revendeur Agréé Baby Lock.

Baby Lock Consumer Helpline: 800-313-4110

Service d'Assistance aux Consommateurs Baby Lock: 800-313-4110

www.babylock.com

Note

- Please read Terms of Use for various Embroidery Patterns in Instruction and Reference Guide before using.
- Embroidery time and size of each design in this guide may differ from the information on the machine display. Please use for reference purpose only.

Nota

- Lea las condiciones de uso de los distintos patrones de bordado en la Guía de referencia y de instrucciones antes de su uso.
- El tiempo de bordado y el tamaño de cada diseño en esta guía pueden diferir de la información en la pantalla de la máquina. Por favor, use solo como referencia.

Remarque

- Veuillez lire les conditions d'utilisation de divers motifs de broderie dans le guide d'instructions et de référence avant toute utilisation.
- La durée de broderie et la taille de chaque motif présenté dans ce guide peuvent différer des informations affichées à l'écran de la machine. Merci de les utiliser à titre de référence uniquement.

Contents

- 2 Summary of Embroidery Designs
- 15 Embroidery Designs Color Change Table
- 45 Examples of Combinations
- 46 Create 3D embroidery
- 47 Color Thread Conversion Chart
- 52 Font Name Chart

Contenido

- 2 Resumen de diseños de bordado
- 15 Tabla de cambios de color para diseños de bordado
- 45 Ejemplos de combinaciones
- 46 Crear bordados en 3D
- 47 Tabla de conversión de hilos de color
- 52 Diagrama de nombre de las fuentes

Table des matières

- 2 Sommaire des motifs de broderie
- 15 Tableau de changement de couleur des motifs de broderie
- 45 Exemples de combinaisons
- 46 Créez une broderie 3D
- 47 Tableau de conversion des fils de couleur
- 52 Tableau des noms de polices

Summary of Embroidery Designs

Resumen de diseños de bordado

Sommaire des motifs de broderie

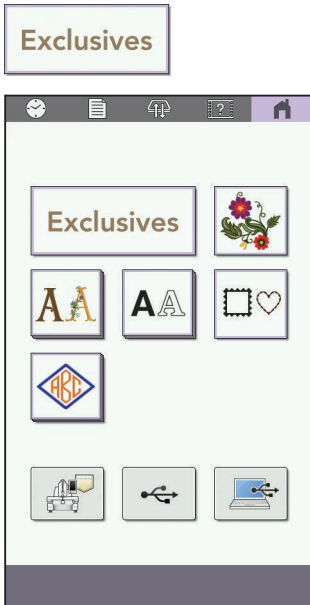

Floral

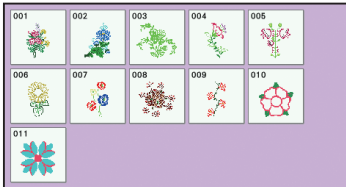

Quilting

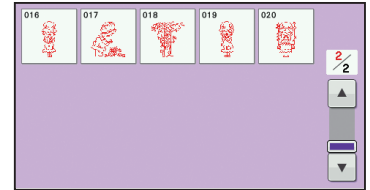
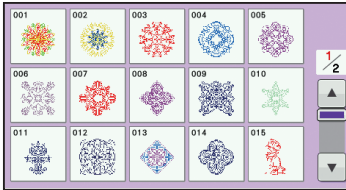

Home Accents

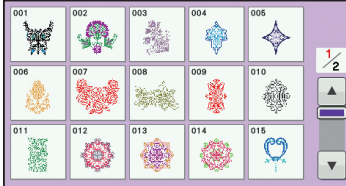

Novelty



Badges



Sashiko

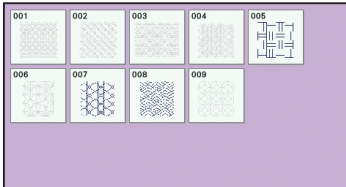

Sportograms



Variety

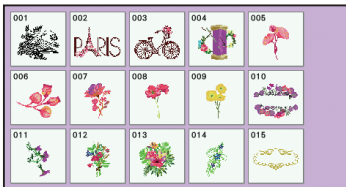

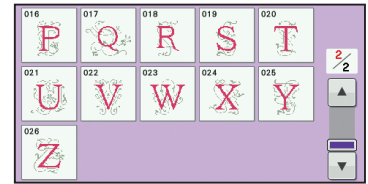
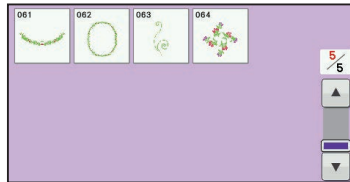
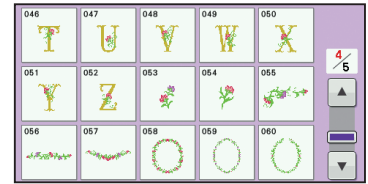
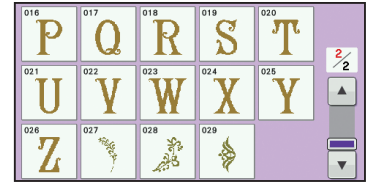
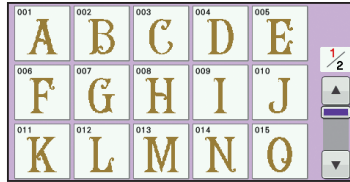
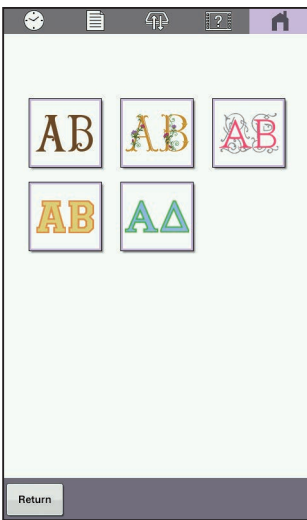
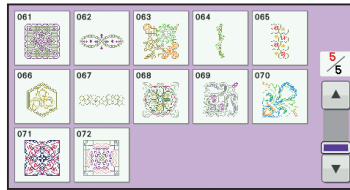
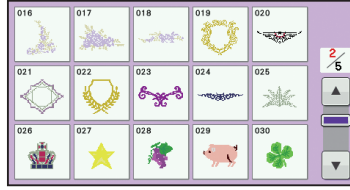
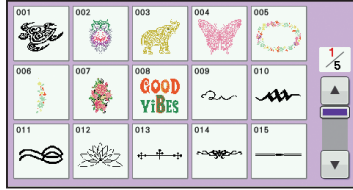

AB

001	A	B	C	D	E
006	F	G	H	I	J
011	K	L	M	N	O

016	P	Q	R	S	T
021	U	V	W	X	Y
026	Z	0	1	2	3

031	4	5	6	7	8
036	9				

AA

001	A	B	Γ	Δ	E
006	Z	H	Θ	I	K
011	Λ	M	N	Ξ	O

016	Π	P	Σ	T	Υ
021	Φ	X	Ψ	Ω	

AA

Exclusive Script

01	ABC	ABC	ABC
04	ABC	ABC	ABC
07	ABC	ABC	ABC
10	ABC	ABC	ABC
13	ABC	ABC	ABC

16	ABC	ABC	ABC
19	ABC	ABC	ABC
22	ABC	ABC	ABC
25	ABCD	ABCD	ABC
28	ABC	ABCDEFGH	
30	AB	AB	

T01	ABC
-----	-----

Exclusive Script

ABC	abc	0-9,.	&?! A B C D E F G H
I J K L M N O P	Delete	←	⌵

ABC	abc	0-9,.	&?! a b c d e f g h
i j k l m n o p	Delete	←	⌵

ABC	abc	0-9,.	&?! 0 1 2 3 4 5 6 7
8 9 - . ,	Delete	←	⌵

ABC	abc	0-9,.	&?! ? ! / ' ,
Delete	←	⌵	

ABC

ABC	abc	0-9,.	&?! A Aä N Nñ
A B C D E F G H	Delete	←	⌵

ABC	abc	0-9,.	&?! A Aä N Nñ
a b c d e f g h	Delete	←	⌵

ABC	abc	0-9,.	&?! A Aä N Nñ
0 1 2 3 4 5 6 7	Delete	←	⌵

Summary of Embroidery Designs
 Resumen de diseños de bordado
 Sommaire des motifs de broderie

02
ABC

ABC	abc	0-9..	&?! 	ÄÄä	ÑÑñ			
&	?	!	@	<	>	()	Delete
[]	/	\	~	:	:	©	
®	™	“	”	”	’	’	’	

ABC	abc	0-9..	&?! 	ÄÄä	ÑÑñ			
Â	Ă	Ą	Æ	à	á	â	ã	Delete
ä	å	æ	Ç	ç	Ð	È	É	
Ê	Ë	è	é	ê	ë	Í	Ï	
ì	í	î	ï	ì				

ABC	abc	0-9..	&?! 	ÄÄä	ÑÑñ			
Ń	Ň	ň	Ŏ	Ō	Ø	Œ	Œ	Delete
ò	ó	ô	ö	ø	ó	œ	í	
ť	Ů	Ů	ù	ú	û	ü	ž	
Ɔ	Ɔ	Ɔ						

ABC	abc	0-9..	&?! 	ÄÄä	ÑÑñ			
A	B	C	D	E	F	G	H	Delete
I	J	K	L	M	N	O	P	
Q	R	S	T	U	V	W	X	
Y	Z							

ABC	abc	0-9..	&?! 	ÄÄä	ÑÑñ			
a	b	c	d	e	f	g	h	Delete
i	j	k	l	m	n	o	p	
q	r	s	t	u	v	w	x	
y	z							

ABC	abc	0-9..	&?! 	ÄÄä	ÑÑñ			
0	1	2	3	4	5	6	7	Delete
8	9	#	%	\$	£	€	¥	
-	+	x	÷	=	*	.	,	

ABC	abc	0-9..	&?! 	ÄÄä	ÑÑñ			
&	?	!	@	<	>	()	Delete
[]	/	\	~	:	:	©	
®	™	“	”	”	’	’	’	

ABC	abc	0-9..	&?! 	ÄÄä	ÑÑñ			
Â	Ă	Ą	Æ	à	á	â	ã	Delete
ä	å	æ	Ç	ç	Ð	È	É	
Ê	Ë	è	é	ê	ë	Í	Ï	
ì	í	î	ï	ì				

ABC	abc	0-9..	&?! 	ÄÄä	ÑÑñ			
Ń	Ň	ň	Ŏ	Ō	Ø	Œ	Œ	Delete
ò	ó	ô	ö	ø	ó	œ	í	
ť	Ů	Ů	ù	ú	û	ü	ž	
Ɔ	Ɔ	Ɔ						

03
ABC

ABC	abc	0-9..	&?! 	ÄÄä	ÑÑñ			
A	B	C	D	E	F	G	H	Delete
I	J	K	L	M	N	O	P	
Q	R	S	T	U	V	W	X	
Y	Z							

ABC	abc	0-9..	&?! 	ÄÄä	ÑÑñ			
a	b	c	d	e	f	g	h	Delete
i	j	k	l	m	n	o	p	
q	r	s	t	u	v	w	x	
y	z							

ABC	abc	0-9..	&?! 	ÄÄä	ÑÑñ			
0	1	2	3	4	5	6	7	Delete
8	9	#	%	\$	£	€	¥	
-	+	x	÷	=	*	.	,	

ABC	abc	0-9..	&?! 	ÄÄä	ÑÑñ			
&	?	!	@	<	>	()	Delete
[]	/	\	~	:	:	©	
®	™	“	”	”	’	’	’	

ABC	abc	0-9..	&?! 	ÄÄä	ÑÑñ			
Â	Ă	Ą	Æ	à	á	â	ã	Delete
ä	å	æ	Ç	ç	Ð	È	É	
Ê	Ë	è	é	ê	ë	Í	Ï	
ì	í	î	ï	ì				

ABC	abc	0-9..	&?! 	ÄÄä	ÑÑñ			
Ń	Ň	ň	Ŏ	Ō	Ø	Œ	Œ	Delete
ò	ó	ô	ö	ø	ó	œ	í	
šť	Ů	Ů	ù	ú	û	ü		
š	š	š	š	š	š	š	š	

04
ABC

ABC	abc	0-9..	&?! 	ÄÄä	ÈÈè	ňňŎ	ŤŤť	
A	B	C	D	E	F	G	H	Delete
I	J	K	L	M	N	O	P	
Q	R	S	T	U	V	W	X	
Y	Z							

ABC	abc	0-9..	&?! 	ÄÄä	ÈÈè	ňňŎ	ŤŤť	
a	b	c	d	e	f	g	h	Delete
i	j	k	l	m	n	o	p	
q	r	s	t	u	v	w	x	
y	z							

ABC	abc	0-9..	&?! 	ÄÄä	ÈÈè	ňňŎ	ŤŤť	
0	1	2	3	4	5	6	7	Delete
8	9	#	%	\$	£	€	¥	
-	+	x	÷	=	*	.	,	

ABC	abc	0-9..	&?! 	ÄÄä	ÈÈè	ňňŎ	ŤŤť	
&	?	!	@	<	>	()	Delete
[]	/	\	~	:	:	©	
®	™	“	”	”	’	’	’	

ABC	abc	0-9..	&?! 	ÄÄä	ÈÈè	ňňŎ	ŤŤť	
À	Á	Â	Ã	Ä	Å	Æ	Ả	Delete
Ạ	à	á	â	ã	ä	å	æ	
ă	ą	ç	ć	č	ĉ	ċ		
đ	đ	d'						

ABC	abc	0-9..	&?! 	ÄÄä	ÈÈè	ňňŎ	ŤŤť	
È	É	Ê	Ë	Ě	È	è	é	Delete
ê	ë	ę	ě	ě	Ĝ	ğ	ì	
í	î	ï	ì	í	î	ï	ì	
ï	ì	ł	ı	ł	ñ	ñ	ñ	

ABC	abc	0-9..	&?! 	ÄÄä	ÈÈè	ňňŎ	ŤŤť	
ñ	ñ	ñ	Ŏ	Ō	Ō	Ō	Ō	Delete
ø	ø	œ	Ŕ	Ŕ	ŕ	ř	š	
š	š	š	š	š	š	š		

ABC	abc	0-9..	&?! 	ÄÄä	ÈÈè	ňňŎ	ŤŤť	
Ť	Ť	Ť	ť	ť	ť	Ů	Ů	Delete
Ů	Ů	Ů	ù	ú	ú	û	û	
Ý	ý	Ž	Ž	ž	ž	ž		
Ɔ	Ɔ	Ɔ						

05 ABC

ABC	abc	0-9..	&?!	ÄÄä	ÉÉé	ññÖ	ŤŤť	
A	B	C	D	E	F	G	H	
I	J	K	L	M	N	O	P	
Q	R	S	T	U	V	W	X	
Y	Z							⌫

ABC	abc	0-9..	&?!	ÄÄä	ÉÉé	ññÖ	ŤŤť	
a	b	c	d	e	f	g	h	
i	j	k	l	m	n	o	p	
q	r	s	t	u	v	w	x	
y	z							⌫

ABC	abc	0-9..	&?!	ÄÄä	ÉÉé	ññÖ	ŤŤť	
0	1	2	3	4	5	6	7	
8	9	#	%	\$	£	€	¥	
-	+	x	÷	=	*	.	,	
								⌫

ABC	abc	0-9..	&?!	ÄÄä	ÉÉé	ññÖ	ŤŤť	
&	?	!	@	<	>	()	
[]	/	\	~	:	;	©	
®	™	“	”	”	’	’	’	
								⌫

ABC	abc	0-9..	&?!	ÄÄä	ÉÉé	ññÖ	ŤŤť	
À	Á	Â	Ã	Ä	Å	Æ	Ǽ	
Ą	à	á	â	ã	ä	å	æ	
ā	ą	Ç	Ć	Ĉ	ç	ć	ĉ	
Đ	Đ	d'						⌫

ABC	abc	0-9..	&?!	ÄÄä	ÉÉé	ññÖ	ŤŤť	
È	É	Ê	Ë	Ě	Ě	è	é	
ê	ë	ë	ë	ě	Ě	Ě	ì	
Í	Î	Ï	Ì	Í	Ì	í	ì	
ï	ì	Ł	ł	ł	Ń	Ń	Ń	
								⌫

ABC	abc	0-9..	&?!	ÄÄä	ÉÉé	ññÖ	ŤŤť
ñ	ń	ň	ò	ó	ô	õ	ö
ø	ő	œ	Ř	Ř	ř	ř	Ş
Š	š	Ş	ş	š	š	ş	⌫

ABC	abc	0-9..	&?!	ÄÄä	ÉÉé	ññÖ	ŤŤť	
Ť	Ť	Ť	t'	t	t	Ù	Ú	
Û	Ü	Û	ù	ú	û	ü	ú	
Ý	ý	Ž	Ž	ž	ž	ž	ž	
Ɔ	Ɔ	β						⌫

06 ABC

ABC	abc	0-9..	&?!	ÄÄä	ÉÉé	ññÖ	ŤŤť	
À	Á	Â	Ã	Ä	Å	Æ	Ǽ	
Ą	à	á	â	ã	ä	å	æ	
ā	ą	Ç	Ć	Ĉ	ç	ć	ĉ	
Đ	Đ	d'						⌫

ABC	abc	0-9..	&?!	ÄÄä	ÉÉé	ññÖ	ŤŤť	
À	Á	Â	Ã	Ä	Å	Æ	Ǽ	
Ą	à	á	â	ã	ä	å	æ	
ā	ą	Ç	Ć	Ĉ	ç	ć	ĉ	
Đ	Đ	d'						⌫

ABC	abc	0-9..	&?!	ÄÄä	ÉÉé	ññÖ	ŤŤť	
0	1	2	3	4	5	6	7	
8	9	#	%	\$	£	€	¥	
-	+	x	÷	=	*	.	,	
								⌫

ABC	abc	0-9..	&?!	ÄÄä	ÉÉé	ññÖ	ŤŤť	
&	?	!	@	<	>	()	
[]	/	\	~	:	;	©	
®	™	“	”	”	’	’	’	
								⌫

ABC	abc	0-9..	&?!	ÄÄä	ÉÉé	ññÖ	ŤŤť	
À	Á	Â	Ã	Ä	Å	Æ	Ǽ	
Ą	à	á	â	ã	ä	å	æ	
ā	ą	Ç	Ć	Ĉ	ç	ć	ĉ	
Đ	Đ	d'						⌫

ABC	abc	0-9..	&?!	ÄÄä	ÉÉé	ññÖ	ŤŤť	
À	Á	Â	Ã	Ä	Å	Æ	Ǽ	
Ą	à	á	â	ã	ä	å	æ	
ā	ą	Ç	Ć	Ĉ	ç	ć	ĉ	
Đ	Đ	d'						⌫

07 ABC

ABC	abc	0-9..	&?!	ÄÄä	ÉÉé	ññÖ	ŤŤť	
À	Á	Â	Ã	Ä	Å	Æ	Ǽ	
Ą	à	á	â	ã	ä	å	æ	
ā	ą	Ç	Ć	Ĉ	ç	ć	ĉ	
Đ	Đ	d'						⌫

ABC	abc	0-9..	&?!	ÄÄä	ÉÉé	ññÖ	ŤŤť	
a	b	c	d	e	f	g	h	
i	j	k	l	m	n	o	p	
q	r	s	t	u	v	w	x	
y	z							⌫

ABC	abc	0-9..	&?!	ÄÄä	ÉÉé	ññÖ	ŤŤť	
0	1	2	3	4	5	6	7	
8	9	#	%	\$	£	€	¥	
-	+	x	÷	=	*	.	,	
								⌫

ABC	abc	0-9..	&?!	ÄÄä	ÉÉé	ññÖ	ŤŤť	
È	É	Ê	Ë	Ě	Ě	è	é	
ê	ë	ë	ë	ě	Ě	Ě	ì	
Í	Î	Ï	Ì	Í	Ì	í	ì	
ï	ì	Ł	ł	ł	Ń	Ń	Ń	
								⌫

ABC	abc	0-9..	&?!	ÄÄä	ÉÉé	ññÖ	ŤŤť	
À	Á	Â	Ã	Ä	Å	Æ	Ǽ	
Ą	à	á	â	ã	ä	å	æ	
ā	ą	Ç	Ć	Ĉ	ç	ć	ĉ	
Đ	Đ	d'						⌫

ABC	abc	0-9..	&?!	ÄÄä	ÉÉé	ññÖ	ŤŤť	
À	Á	Â	Ã	Ä	Å	Æ	Ǽ	
Ą	à	á	â	ã	ä	å	æ	
ā	ą	Ç	Ć	Ĉ	ç	ć	ĉ	
Đ	Đ	d'						⌫

ABC	abc	0-9..	&?!	ÄÄä	ÉÉé	ññÖ	ŤŤť	
À	Á	Â	Ã	Ä	Å	Æ	Ǽ	
Ą	à	á	â	ã	ä	å	æ	
ā	ą	Ç	Ć	Ĉ	ç	ć	ĉ	
Đ	Đ	d'						⌫

ABC	abc	0-9..	&?!	ÄÄä	ÉÉé	ññÖ	ŤŤť	
Ť	Ť	Ť	t'	t	t	Ù	Ú	
Û	Ü	Û	ù	ú	û	ü	ú	
Ý	ý	Ž	Ž	ž	ž	ž	ž	
Ɔ	Ɔ	β						⌫

ABC	abc	0-9..	&?!	ÄÄä	ÉÉé	ññÖ	ŤŤť	
Ť	Ť	Ť	t'	t	t	Ù	Ú	
Û	Ü	Û	ù	ú	û	ü	ú	
Ý	ý	Ž	Ž	ž	ž	ž	ž	
Ɔ	Ɔ	β						⌫

08 ABC

ABC	abc	0-9..	&?!	ÄÄä	ÑÑñ			
A	B	C	D	E	F	G	H	Delete
I	J	K	L	M	N	O	P	
Q	R	S	T	U	V	W	X	
Y	Z							

ABC	abc	0-9..	&?!	ÄÄä	ÑÑñ			
a	b	c	d	e	f	g	h	Delete
i	j	k	l	m	n	o	p	
q	r	s	t	u	v	w	x	
y	z							

ABC	abc	0-9..	&?!	ÄÄä	ÑÑñ			
0	1	2	3	4	5	6	7	Delete
8	9	#	%	\$	£	-	+	
=	*	.	,					

ABC	abc	0-9..	&?!	ÄÄä	ÑÑñ			
&	?	!	@	<	>	()	Delete
		/	\	~	:	;	"	
'								

ABC	abc	0-9..	&?!	ÄÄä	ÑÑñ			
Â	Ã	Ä	Æ	à	á	â	ã	Delete
ä	å	æ	ç	ç	ð	ë	é	
ê	ë	è	é	è	ë	í	ï	
ì	í	î						

ABC	abc	0-9..	&?!	ÄÄä	ÑÑñ			
Ñ	ñ	Ò	ó	Ô	õ	Ö	ø	Delete
ø	ø	Ù	Ú	Û	Ü	Ý	ÿ	
þ	þ	ß						

09 ABC

ABC	abc	0-9..	&?!	ÄÄä	ÑÑñ			
œ	œ	œ	œ	œ	œ	œ	œ	Delete
œ	œ	œ	œ	œ	œ	œ	œ	
œ	œ	œ	œ	œ	œ	œ	œ	
œ	œ							

ABC	abc	0-9..	&?!	ÄÄä	ÑÑñ			
a	b	c	d	e	f	g	h	Delete
i	j	k	l	m	n	o	p	
q	r	s	t	u	v	w	x	
y	z							

ABC	abc	0-9..	&?!	ÄÄä	ÑÑñ			
0	1	2	3	4	5	6	7	Delete
8	9	#	%	\$	£	-	+	
=	*	.	,					

ABC	abc	0-9..	&?!	ÄÄä	ÑÑñ			
&	?	!	@	<	>	()	Delete
		/	\	-	:	;	"	
'								

ABC	abc	0-9..	&?!	ÄÄä	ÑÑñ			
á	â	ã	ä	å	æ	ç	è	Delete
é	ê	ë	è	é	ê	ë	í	
ì	í	î						

ABC	abc	0-9..	&?!	ÄÄä	ÑÑñ			
œ	œ	œ	œ	œ	œ	œ	œ	Delete
œ	œ	œ	œ	œ	œ	œ	œ	
œ	œ	œ	œ	œ	œ	œ	œ	
œ	œ							

10 ABC

ABC	abc	0-9..	&?!	ÄÄä	ÑÑñ			
œ	œ	œ	œ	œ	œ	œ	œ	Delete
œ	œ	œ	œ	œ	œ	œ	œ	
œ	œ	œ	œ	œ	œ	œ	œ	
œ	œ							

ABC	abc	0-9..	&?!	ÄÄä	ÑÑñ			
a	b	c	d	e	f	g	h	Delete
i	j	k	l	m	n	o	p	
q	r	s	t	u	v	w	x	
y	z							

ABC	abc	0-9..	&?!	ÄÄä	ÑÑñ			
0	1	2	3	4	5	6	7	Delete
8	9	#	%	\$	£	€	¥	
-	+	x	÷	=	*	.	,	

ABC	abc	0-9..	&?!	ÄÄä	ÑÑñ			
&	?	!	@	<	>	()	Delete
		/	\	~	:	;	©	
®	™	"	"	"	'	'	'	

ABC	abc	0-9..	&?!	ÄÄä	ÑÑñ			
œ	œ	œ	œ	œ	œ	œ	œ	Delete
œ	œ	œ	œ	œ	œ	œ	œ	
œ	œ	œ	œ	œ	œ	œ	œ	
œ	œ							

ABC	abc	0-9..	&?!	ÄÄä	ÑÑñ			
œ	œ	œ	œ	œ	œ	œ	œ	Delete
œ	œ	œ	œ	œ	œ	œ	œ	
œ	œ	œ	œ	œ	œ	œ	œ	
œ	œ							

11 ABC

ABC	abc	0-9..	&?!	ÄÄä	ÑÑñ			
A	B	C	D	E	F	G	H	Delete
I	J	K	L	M	N	O	P	
Q	R	S	T	U	V	W	X	
Y	Z							

ABC	abc	0-9..	&?!	ÄÄä	ÑÑñ			
a	b	c	d	e	f	g	h	Delete
i	j	k	l	m	n	o	p	
q	r	s	t	u	v	w	x	
y	z							

ABC	abc	0-9..	&?!	ÄÄä	ÑÑñ			
0	1	2	3	4	5	6	7	Delete
8	9	#	%	\$	£	€	¥	
-	+	x	÷	=	*	.	,	

ABC	abc	0-9..	&?!	ÄÄä	ÑÑñ			
&	?	!	@	<	>	()	Delete
[]	/	\	~	:	;	©	
®	™	"	"	"	'	'	'	

ABC	abc	0-9..	&?!	ÄÄä	ÑÑñ			
Â	Ã	Ä	Æ	à	á	â	ã	Delete
ä	å	æ	ç	ç	ð	ë	é	
ê	ë	è	é	è	ë	í	ï	
ì	í	î	ï	í	ï	í	ï	

ABC	abc	0-9..	&?!	ÄÄä	ÑÑñ			
Ñ	ñ	Ò	ó	Ô	õ	Ö	ø	Delete
ø	ø	Ù	Ú	Û	Ü	Ý	ÿ	
þ	þ	ß						

12 ABC

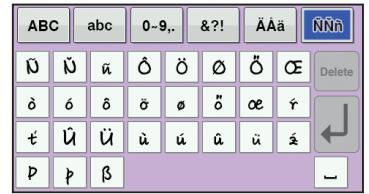
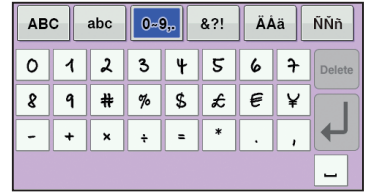
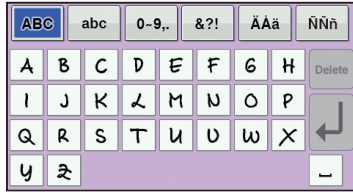

13 ABC

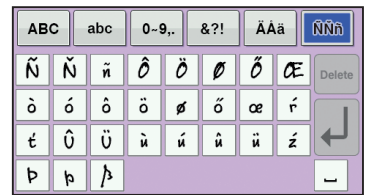
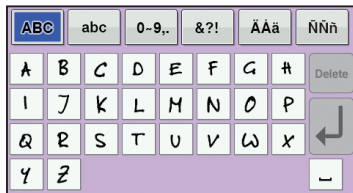

14 ABC

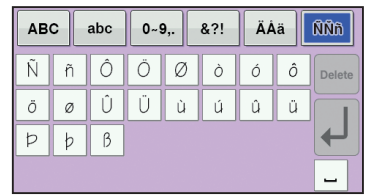
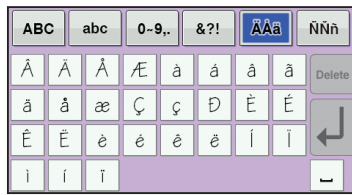
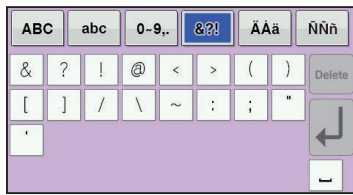
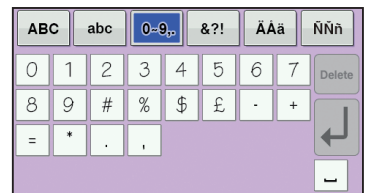
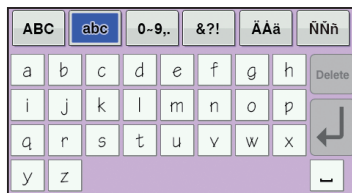
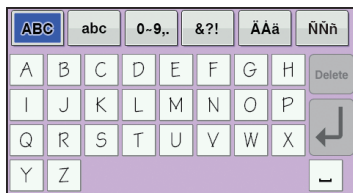

15 ABC

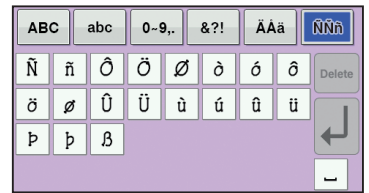
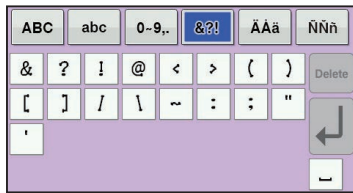
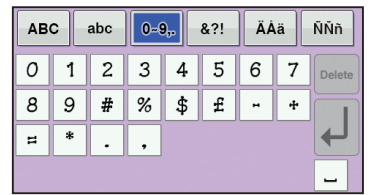
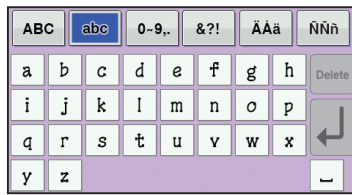
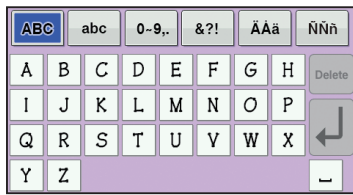

16 ABC

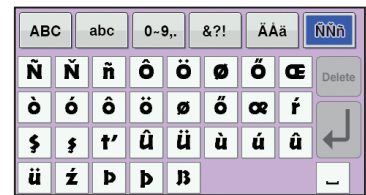
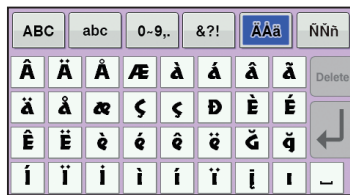
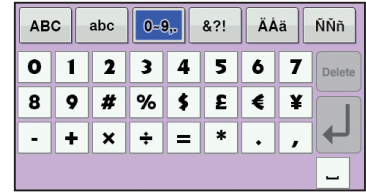
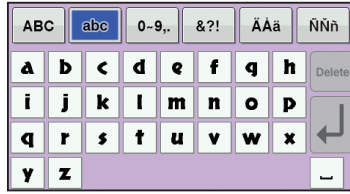
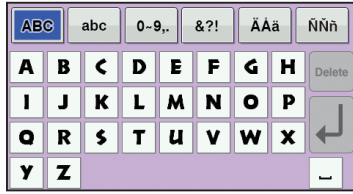

17 ABC

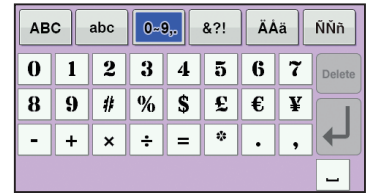
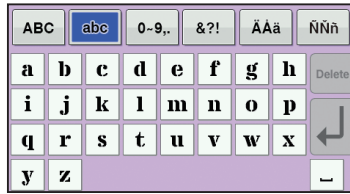
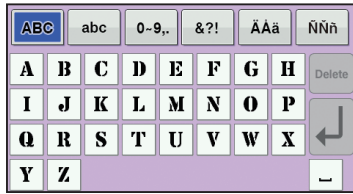

18 ABC

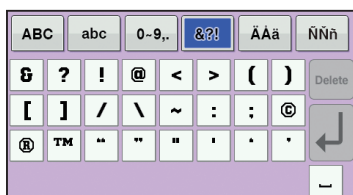
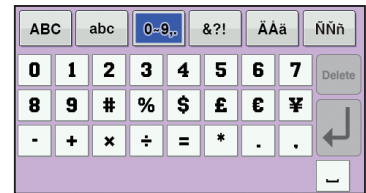
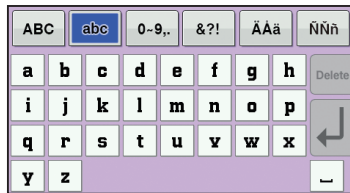
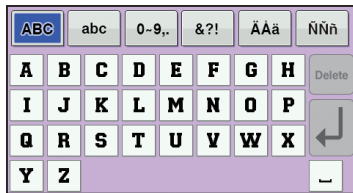

19 ABC

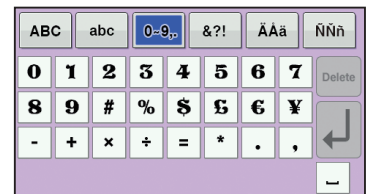
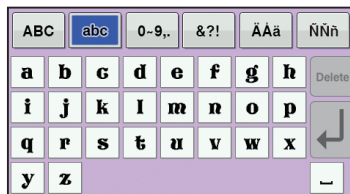
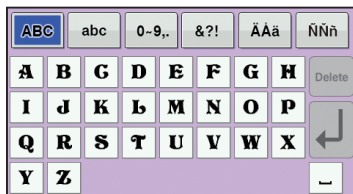

20 ABC

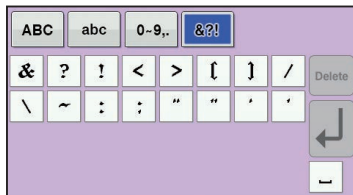
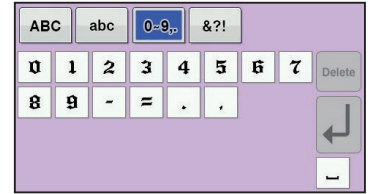
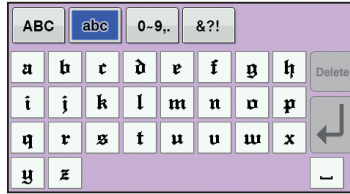
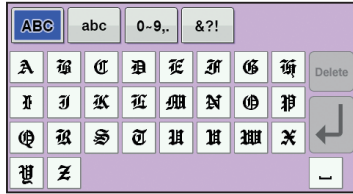

21 ABC

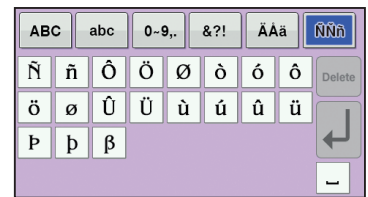
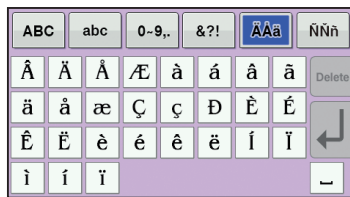
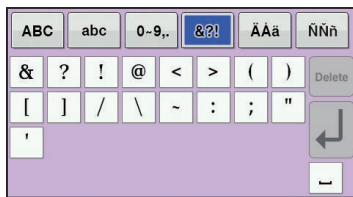
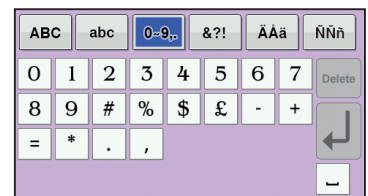
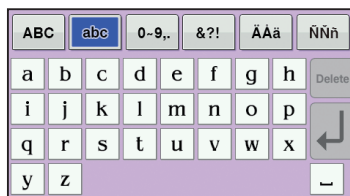
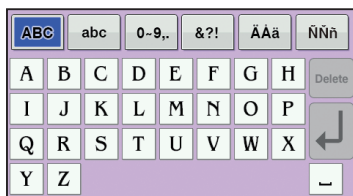

22 ABC

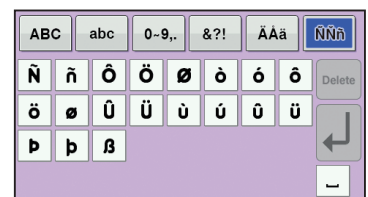
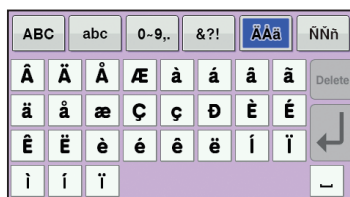
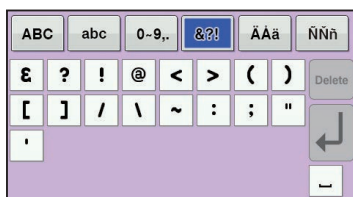
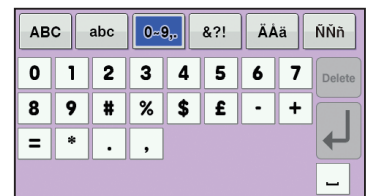
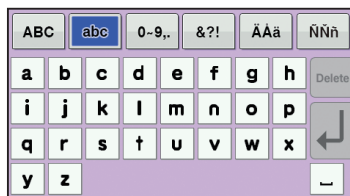
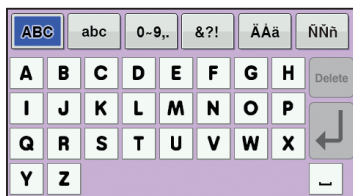

23 ABC

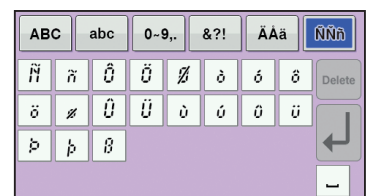
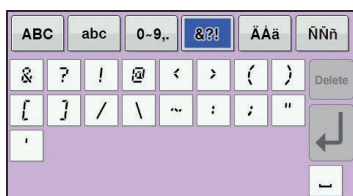
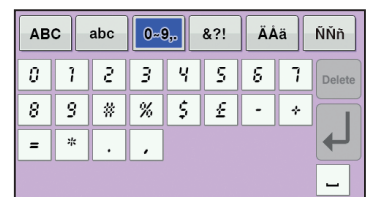
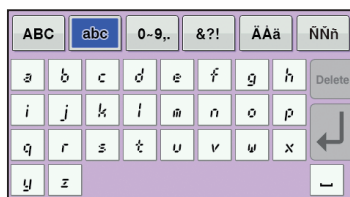
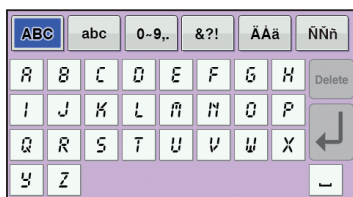

24
ABCD

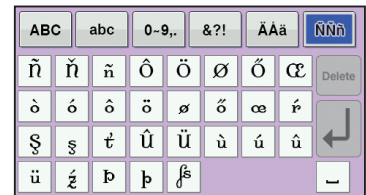
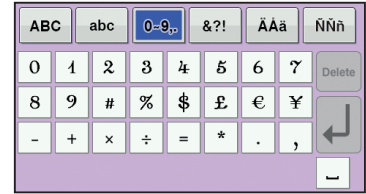

25
ABCD

Small font
 Tipo de letra pequeña
 Petite police

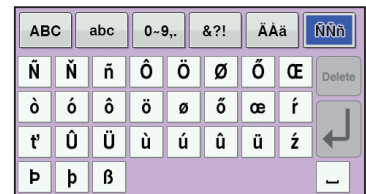
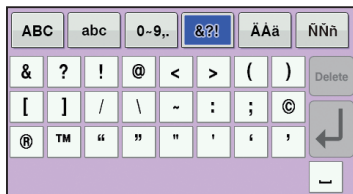
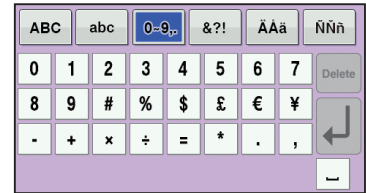
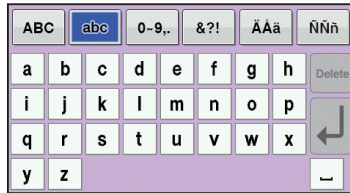
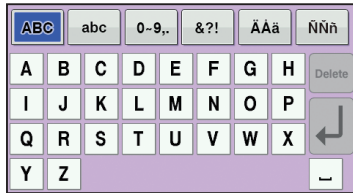

26
ABCD

Small font
 Tipo de letra pequeña
 Petite police

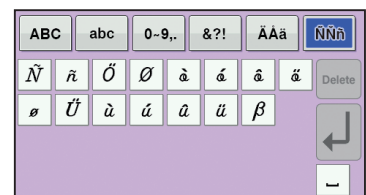
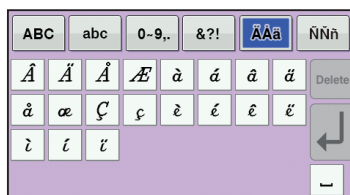
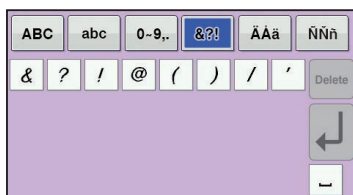
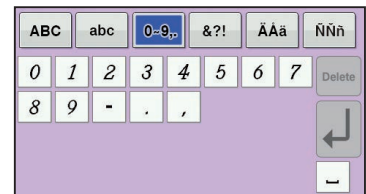
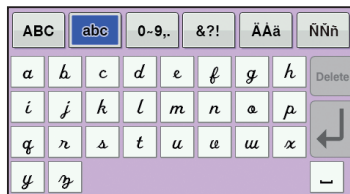
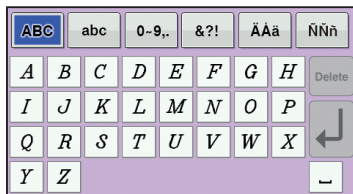

27
ABCD

Small font
 Tipo de letra pequeña
 Petite police

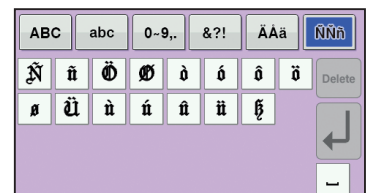
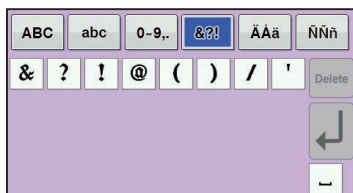
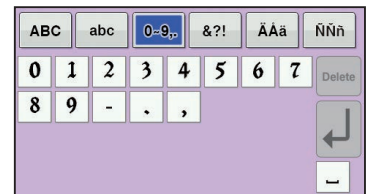
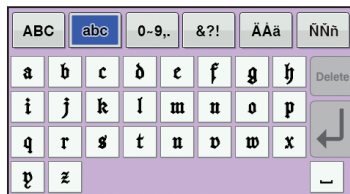
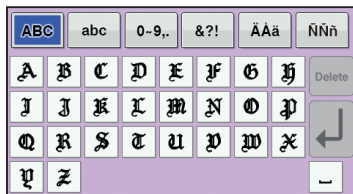

28
АБВГД

Small font
Tipo de letra pequeña
Petite police

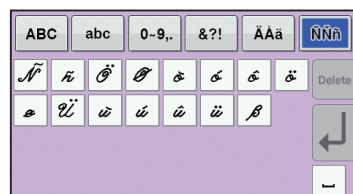
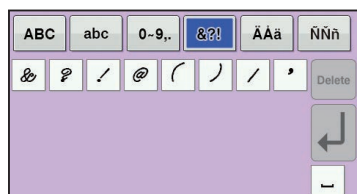
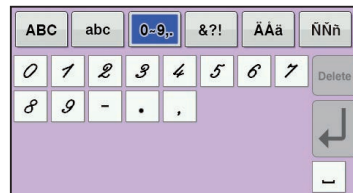
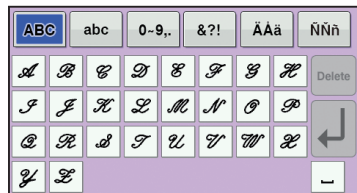

29
ABCDEFGHIH

Small font
Tipo de letra pequeña
Petite police

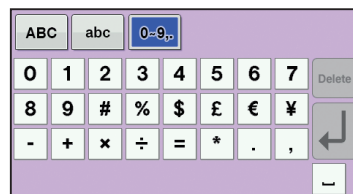
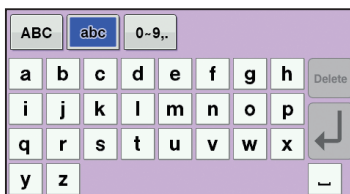
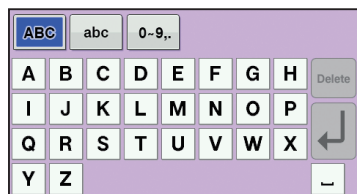

30
АБВ

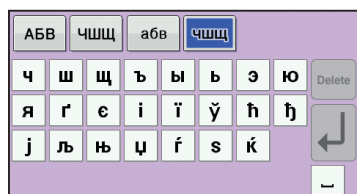
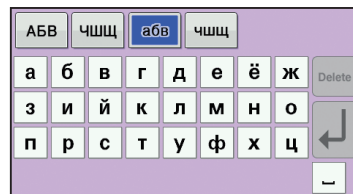

31
АБВ



101
ABC

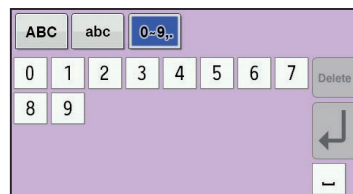
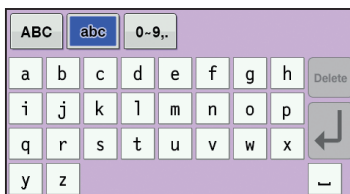
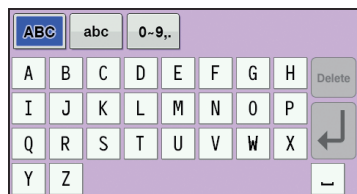

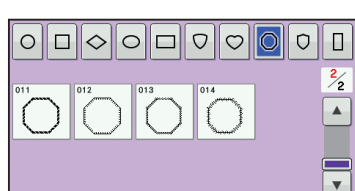
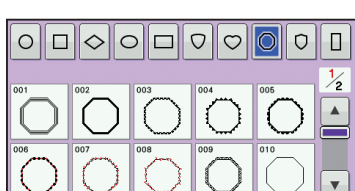
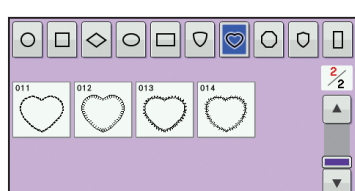
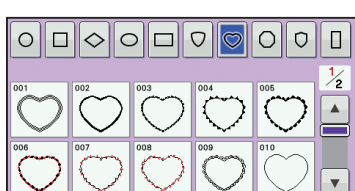
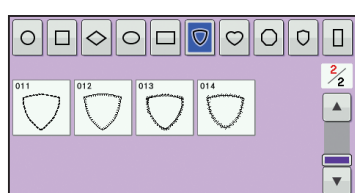
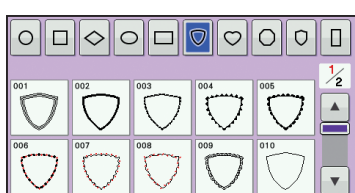
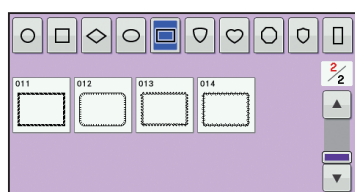
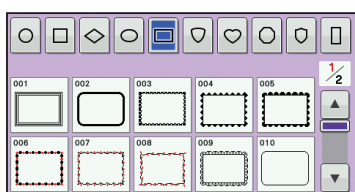
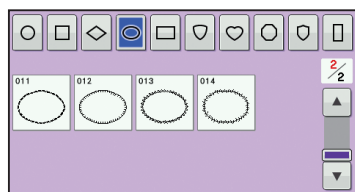
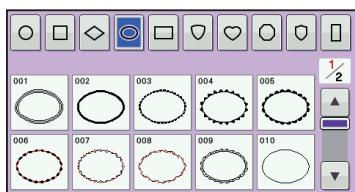
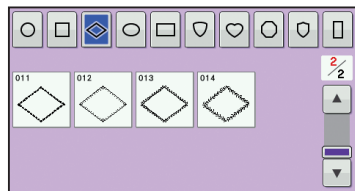
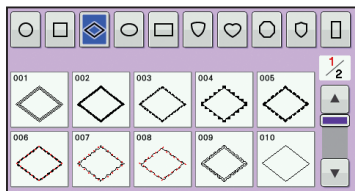
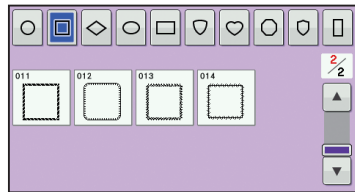
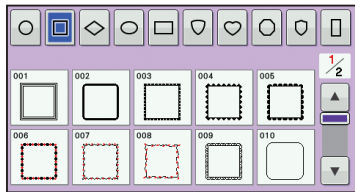
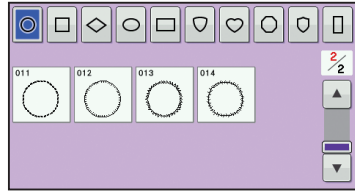
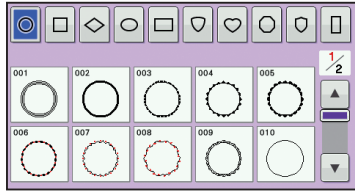

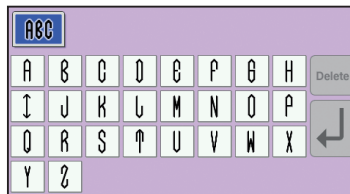
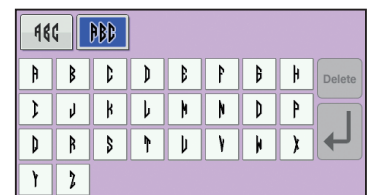
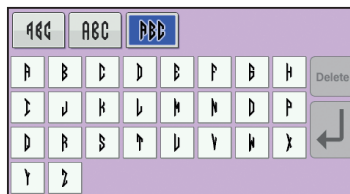
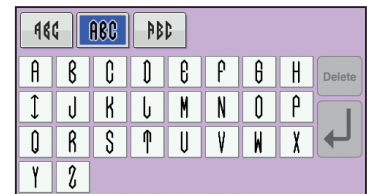
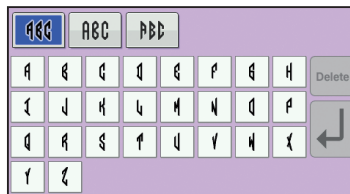
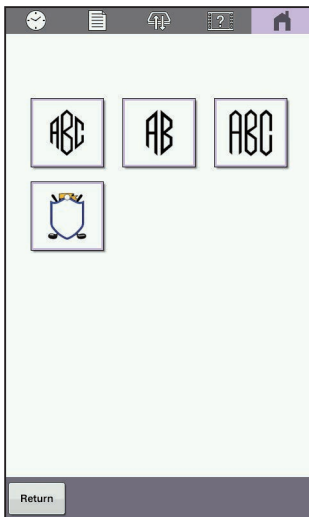
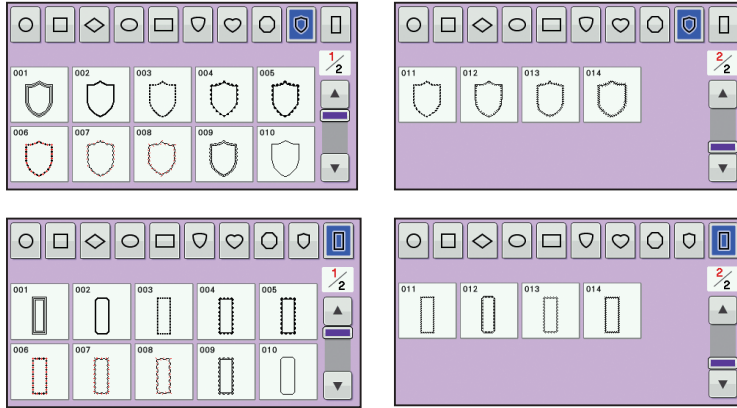

Embroidery Designs Color Change Table

Tabla de cambios de color para diseños de bordado

Tableau de changement de couleur des motifs de broderie

Embroidery time and size of each design in this guide may differ from the information on the machine display. Please use for reference purpose only. The color numbers in this guide are for the Embroidery thread brand unless otherwise noted.

● Patterns marked with ● have been rotated. Check your design placement prior to embroidering.

El tiempo de bordado y el tamaño de cada diseño en esta guía pueden diferir de la información en la pantalla de la máquina. Por favor, use solo como referencia.

Los números de colores en esta guía se refieren a la marca de hilos de Bordado, a menos que se indique lo contrario.

● Los patrones marcado con ● se han girado. Compruebe la colocación del diseño antes de bordar.

La durée de broderie et la taille de chaque motif présenté dans ce guide peuvent différer des informations affichées à l'écran de la machine. Merci de les utiliser à titre de référence uniquement.

Les numéros des couleurs dans ce guide correspondent à la marque de fils à broder, sauf indication contraire.

● Les motifs signalés par ● ont été pivotés. Vérifiez l'emplacement de votre motif avant de commencer à broder.

❖ Baby Lock "Exclusives" Floral designs

❖ Diseños florales "exclusivos" de Baby Lock

❖ Motifs floraux Baby Lock « exclusifs »

Exclusives

Floral



No.1	24 min
1	(328)
2	(808)
3	(534)
4	(804)
5	(807)
6	(107)
↓ 193.8 mm	
↔ 129.4 mm	

Embroidery thread color
Color del hilo de bordado
Couleur du fil de broderie

Order to embroider
Orden para el bordador
Séquence de broderie

Time required for embroidering
Tiempo requerido para el bordado
Durée requise pour broder

Embroidery thread color number
Numero colori filo per ricamo
Numéro de couleur du fil de broderie

Embroidery size
Tecla de tamaño
Taille de la broderie



No.6	6 min
1	(515)
2	(519)
3	(214)
4	(330)
↓ 176.0 mm	
↔ 104.9 mm	



No.2	19 min
1	(420)
2	(519)
3	(515)
4	(519)
5	(017)
6	(406)
7	(206)
↓ 166.7 mm	
↔ 123.0 mm	



No.4	9 min
1	(513)
2	(620)
3	(807)
4	(507)
5	(513)
↓ 176.0 mm	
↔ 121.3 mm	



No.7	14 min
1	(509)
2	(010)
3	(405)
4	(800)
↓ 151.0 mm	
↔ 95.0 mm	



No.3	12 min
1	(509)
↓ 112.8 mm	
↔ 127.6 mm	



No.5	19 min
1	(107)
2	(027)
3	(509)
4	(107)
5	(900)
↓ 190.0 mm	
↔ 160.2 mm	



No.8	23 min
1	(124)
2	(058)
3	(507)
4	(058)
5	(800)
6	(058)
↓ 149.5 mm	
↔ 152.4 mm	

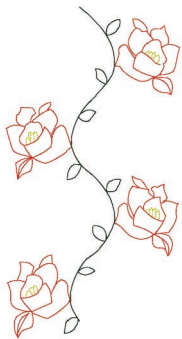

No.9	3 min
1	■ (205)
2	■ (800)
3	■ (519)
↓	175.7 mm
↔	92.1 mm

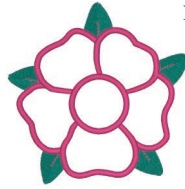

No.10	8 min
1	■ (534)
2	■ (086)
↓	96.0 mm
↔	94.8 mm



No.11	13 min
1	■ (017)
2	■ (086)
↓	76.0 mm
↔	76.0 mm

❖ Baby Lock "Exclusives" Quilting designs

❖ Diseños de acolchado "exclusivos" de Baby Lock

❖ Motifs Courtepointe « exclusifs » Baby Lock

Exclusives

Quilting



No.1	17 min
1	■ (206)
2	■ (800)
3	■ (513)
↓	146.0 mm
↔	141.8 mm

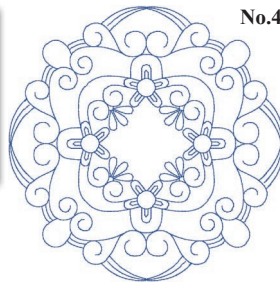

No.4	9 min
1	■ (420)
↓	146.0 mm
↔	146.0 mm

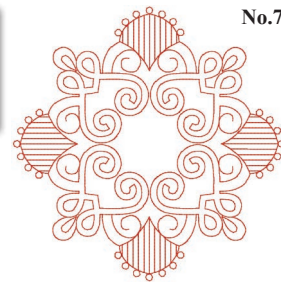

No.7	10 min
1	■ (800)
↓	146.0 mm
↔	144.8 mm

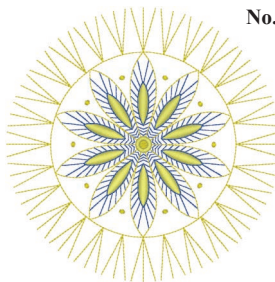

No.2	17 min
1	■ (405)
2	■ (206)
3	■ (202)
4	■ (405)
5	■ (206)
↓	146.0 mm
↔	146.0 mm

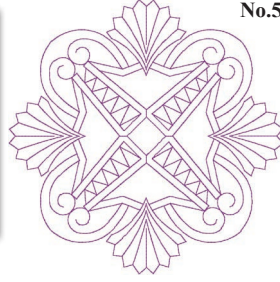

No.5	9 min
1	■ (620)
↓	146.0 mm
↔	146.0 mm



No.8	11 min
1	■ (620)
↓	146.0 mm
↔	146.0 mm

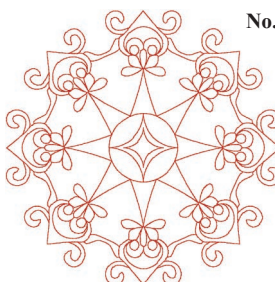

No.3	10 min
1	■ (800)
↓	146.0 mm
↔	146.0 mm

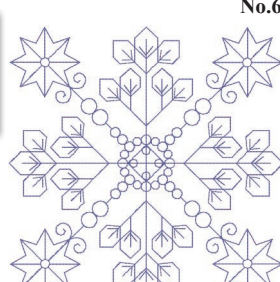

No.6	11 min
1	■ (607)
↓	146.0 mm
↔	146.0 mm

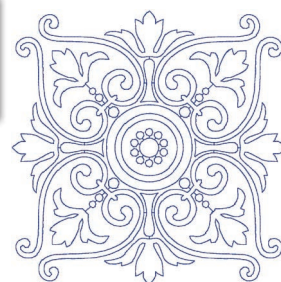

No.9	10 min
1	■ (406)
↓	146.0 mm
↔	146.0 mm

Embroidery Designs Color Change Table
Tabla de cambios de color para diseños de bordado
Tableau de changement de couleur des motifs de broderie

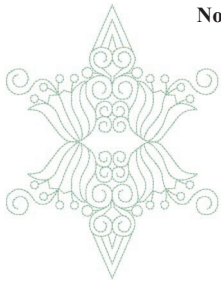

No.10	6 min
1	■ (542)
↓	146.0 mm
↔	112.8 mm



No.15	3 min
1	■ (800)
↓	176.0 mm
↔	107.3 mm



No.19	3 min
1	■ (800)
↓	176.0 mm
↔	73.7 mm

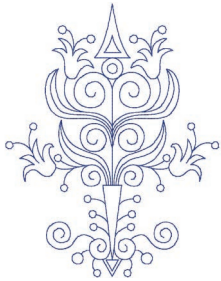

No.11	7 min
1	■ (406)
↓	146.0 mm
↔	113.4 mm



No.16	3 min
1	■ (800)
↓	176.0 mm
↔	73.5 mm



No.20	5 min
1	■ (800)
↓	176.0 mm
↔	102.5 mm

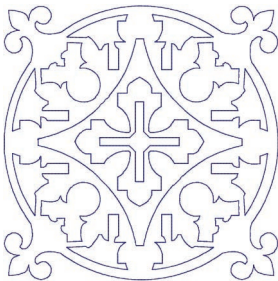

No.12	7 min
1	■ (007)
↓	146.0 mm
↔	146.0 mm

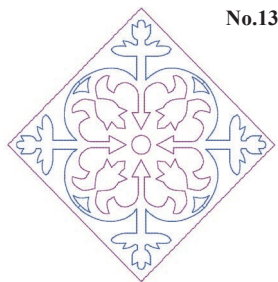

No.13	4 min
1	■ (620)
2	■ (420)
3	■ (620)
↓	146.0 mm
↔	142.2 mm

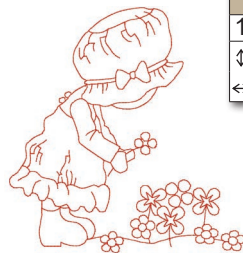

No.17	4 min
1	■ (800)
↓	130.3 mm
↔	125.9 mm

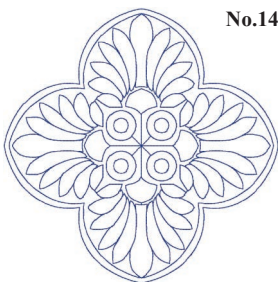

No.14	8 min
1	■ (406)
↓	146.0 mm
↔	146.0 mm



No.18	4 min
1	■ (800)
↓	136.2 mm
↔	126.0 mm

- ❖ Baby Lock "Exclusives" Home Accents designs
- ❖ Diseños domésticos destacados "exclusivos" de Baby Lock
- ❖ Motifs Décorations intérieures « exclusifs » Baby Lock

Exclusives



Home Accents



No.1

41 min		
1 (607)	7 (019)	13 (019)
2 (019)	8 (017)	14 (804)
3 (017)	9 (804)	15 (420)
4 (804)	10 (900)	16 (900)
5 (900)	11 (017)	
6 (607)	12 (607)	

↓ 190.0 mm ↔ 164.9 mm

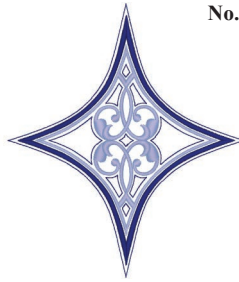

No.5

9 min	
1 (804)	
2 (007)	

↓ 145.5 mm
↔ 126.0 mm

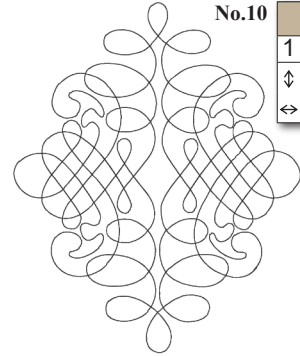

No.10

4 min	
1 (707)	

↓ 186.1 mm
↔ 152.4 mm



No.11

4 min	
1 (534)	

↓ 148.0 mm
↔ 81.6 mm



No.6

8 min	
1 (126)	

↓ 152.0 mm
↔ 102.4 mm

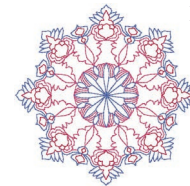

No.12

6 min	
1 (086)	
2 (107)	
3 (070)	

↓ 96.0 mm
↔ 96.3 mm

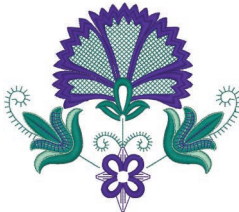

No.2

19 min		
1 (534)	5 (534)	9 (534)
2 (614)	6 (542)	10 (542)
3 (534)	7 (614)	11 (614)
4 (542)	8 (542)	

↓ 111.0 mm ↔ 126.0 mm



No.7

8 min	
1 (800)	

↓ 120.8 mm
↔ 152.3 mm

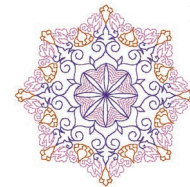

No.13

6 min	
1 (810)	
2 (614)	
3 (337)	

↓ 96.0 mm
↔ 95.9 mm



No.3

9 min	
1 (607)	
2 (804)	

↓ 101.0 mm
↔ 81.1 mm

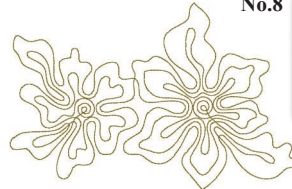

No.8

3 min	
1 (330)	

↓ 99.2 mm
↔ 152.4 mm



No.14

5 min	
1 (513)	
2 (807)	

↓ 96.0 mm
↔ 96.0 mm



No.4

11 min	
1 (019)	
2 (405)	

↓ 139.0 mm
↔ 90.5 mm

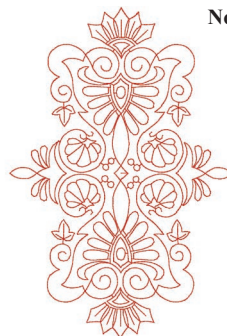

No.9

6 min	
1 (800)	

↓ 176.0 mm
↔ 118.3 mm



No.15

5 min	
1 (017)	
2 (420)	

↓ 96.0 mm
↔ 62.9 mm



No.16

5 min	
1 (017)	

↓ 72.4 mm
↔ 96.0 mm

Embroidery Designs Color Change Table
Tabla de cambios de color para diseños de bordado
Tableau de changement de couleur des motifs de broderie

- ❖ Baby Lock "Exclusives" Novelty designs
- ❖ Diseños novedosos "exclusivos" de Baby Lock
- ❖ Motifs nouveauté Baby Lock « exclusifs »

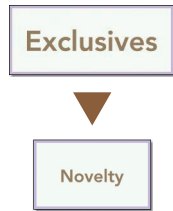

No.1 **22 min**

1	(339)
2	(214)
3	(406)
4	(800)
5	(704)
6	(005)

↓ 196.0 mm
 ↔ 106.8 mm



No.6 **13 min**

1	(030)
2	(800)
3	(513)
4	(509)
5	(027)
6	(348)
7	(330)
8	(001)

↓ 78.8 mm
 ↔ 64.8 mm



No.11 **12 min**

1	(406)
2	(399)
3	(328)

↓ 96.1 mm
 ↔ 77.6 mm



No.2 **17 min**

1	(399)	6	(607)
2	(001)	7	(509)
3	(900)	8	(323)
4	(005)	9	(208)
5	(208)		

↓ 82.5 mm ↔ 96.0 mm



No.7 **22 min**

1	(800)
2	(542)
3	(810)
4	(001)
5	(330)

↓ 111.0 mm
 ↔ 96.0 mm



No.12 **7 min**

1	(399)
2	(328)
3	(019)
4	(406)
5	(399)
6	(328)

↓ 92.6 mm
 ↔ 96.0 mm



No.3 **19 min**

1	(900)	5	(307)
2	(307)	6	(001)
3	(339)	7	(900)
4	(900)		

↓ 96.0 mm ↔ 74.9 mm



No.8 **19 min**

1	(205)
2	(208)
3	(214)
4	(126)
5	(513)
6	(339)
7	(509)

↓ 94.1 mm
 ↔ 96.0 mm



No.13 **16 min**

1	(017)
2	(001)
3	(017)

↓ 95.8 mm
 ↔ 96.0 mm



No.4 **7 min**

1	(058)
---	-------

↓ 91.3 mm
 ↔ 96.0 mm



No.9 **6 min**

1	(019)
2	(328)
3	(406)
4	(328)

↓ 96.0 mm
 ↔ 94.0 mm

No.14 **11 min**

1	(509)
---	-------

↓ 99.8 mm
 ↔ 152.0 mm



No.5 **24 min**

1	(800)
2	(900)
3	(339)
4	(513)
5	(001)

↓ 186.1 mm
 ↔ 196.0 mm



No.10 **10 min**

1	(399)
2	(323)
3	(406)
4	(323)

↓ 92.0 mm
 ↔ 96.0 mm



❖ Baby Lock “Exclusives” Badges designs
 ❖ Diseños Badges “Exclusivos” de Baby Lock
 ❖ Motifs Insigne « exclusifs » Baby Lock



No.1 25 min	
1	■ (515)
2	■ (808)
3	■ (507)
4	■ (534)
↓ 100.0 mm	
↔ 78.4 mm	



No.4 9 min	
1	■ (502)
2	■ (348)
3	■ (202)
4	■ (085)
↓ 90.0 mm	
↔ 90.0 mm	

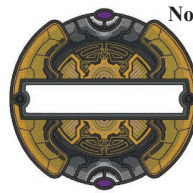

No.7 36 min	
1	■ (900)
2	■ (214)
3	■ (328)
4	■ (817)
5	■ (704)
6	■ (707)
7	■ (005)
8	■ (001)
9	■ (613)
10	■ (348)
11	■ (328)
12	■ (214)
13	■ (900)
14	■ (707)
15	■ (704)
16	■ (900)
↓ 95.1 mm ↔ 100.0 mm	



No.2 22 min	
1	■ (001)
2	■ (800)
3	■ (406)
4	■ (001)
5	■ (800)
↓ 100.0 mm	
↔ 72.1 mm	



No.5 11 min	
1	■ (086)
2	■ (019)
3	■ (214)
4	■ (509)
5	■ (019)
↓ 90.0 mm	
↔ 90.0 mm	



No.8 29 min	
1	■ (900)
2	■ (328)
3	■ (348)
4	■ (900)
↓ 96.8 mm	
↔ 100.0 mm	



No.3 8 min	
1	■ (085)
2	■ (502)
3	■ (017)
4	■ (206)
5	■ (502)
↓ 90.0 mm	
↔ 90.0 mm	



No.6 11 min	
1	■ (420)
2	■ (502)
3	■ (206)
4	■ (420)
↓ 90.0 mm	
↔ 90.0 mm	

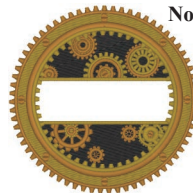

No.9 31 min	
1	■ (900)
2	■ (328)
3	■ (323)
4	■ (328)
5	■ (323)
6	■ (328)
↓ 98.9 mm	
↔ 100.0 mm	

❖ Baby Lock “Exclusives” Sashiko designs
 ❖ Diseños Sashiko “Exclusivos” de Baby Lock
 ❖ Motifs Sashiko « exclusifs » Baby Lock



* If necessary, go to page 2 of the settings screen on your machine to change [Embroidery Background Color] and [Thumbnail Background Color] to visually see the embroidery data on your machine.

* Si es necesario, vaya a la página 2 de la pantalla de ajustes de su máquina para cambiar [Color de fondo del bordado] y [Color de fondo de miniatura] para visualizar los datos de bordado en su máquina.

* Si nécessaire, allez à la page 2 de l'écran des réglages de votre machine pour changer [Couleur d'arrière-plan de la zone de broderie] et [Couleur d'arrière-plan de la zone d'onglets] afin de pouvoir visualiser les données de broderie sur votre machine.

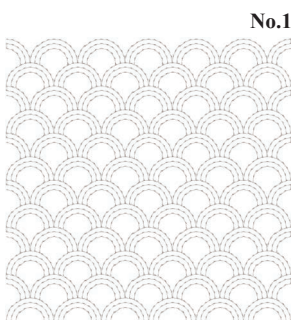

No.1 11 min	
1	■ (001)
↓ 150.0 mm	
↔ 150.0 mm	



No.2 11 min	
1	■ (001)
↓ 150.0 mm	
↔ 155.5 mm	

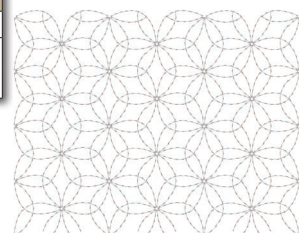

No.3 8 min	
1	■ (001)
↓ 119.0 mm	
↔ 150.0 mm	

Embroidery Designs Color Change Table
Tabla de cambios de color para diseños de bordado
Tableau de changement de couleur des motifs de broderie

	<p>No.4</p> <p>11 min</p> <p>1 (001)</p> <p>↓ 147.9 mm</p> <p>↔ 150.0 mm</p>		<p>No.6</p> <p>6 min</p> <p>1 (001)</p> <p>↓ 150.0 mm</p> <p>↔ 128.0 mm</p>		<p>No.8</p> <p>5 min</p> <p>1 (007)</p> <p>↓ 150.0 mm</p> <p>↔ 142.4 mm</p>
	<p>No.5</p> <p>4 min</p> <p>1 (007)</p> <p>↓ 150.0 mm</p> <p>↔ 150.0 mm</p>		<p>No.7</p> <p>5 min</p> <p>1 (007)</p> <p>↓ 150.0 mm</p> <p>↔ 141.4 mm</p>		<p>No.9</p> <p>5 min</p> <p>1 (001)</p> <p>↓ 150.0 mm</p> <p>↔ 150.0 mm</p>

- ❖ Baby Lock "Exclusives" Sportograms designs
- ❖ Diseños Sportograms "Exclusivos" de Baby Lock
- ❖ Motifs Sportogrammes « exclusifs » Baby Lock

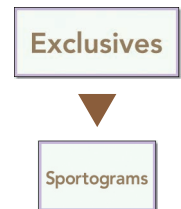

	<p>No.1</p> <p>26 min</p> <p>1 (843)</p> <p>2 (348)</p> <p>3 (704)</p> <p>4 (800)</p> <p>5 (900)</p> <p>6 (707)</p> <p>↓ 130.0 mm</p> <p>↔ 108.6 mm</p>		<p>No.3</p> <p>23 min</p> <p>1 (406)</p> <p>2 (007)</p> <p>3 (900)</p> <p>4 (707)</p> <p>5 (900)</p> <p>↓ 130.0 mm</p> <p>↔ 108.5 mm</p>		<p>No.5</p> <p>26 min</p> <p>1 (001)</p> <p>2 (817)</p> <p>3 (900)</p> <p>↓ 130.0 mm</p> <p>↔ 108.5 mm</p>
	<p>No.2</p> <p>26 min</p> <p>1 (208)</p> <p>2 (126)</p> <p>3 (209)</p> <p>4 (900)</p> <p>5 (707)</p> <p>↓ 130.0 mm</p> <p>↔ 108.5 mm</p>		<p>No.4</p> <p>31 min</p> <p>1 (337)</p> <p>2 (339)</p> <p>3 (058)</p> <p>4 (001)</p> <p>5 (817)</p> <p>6 (058)</p> <p>7 (900)</p> <p>↓ 116.6 mm</p> <p>↔ 130.0 mm</p>		<p>No.6</p> <p>30 min</p> <p>1 (704)</p> <p>2 (707)</p> <p>3 (900)</p> <p>4 (704)</p> <p>5 (900)</p> <p>↓ 130.0 mm</p> <p>↔ 111.7 mm</p>

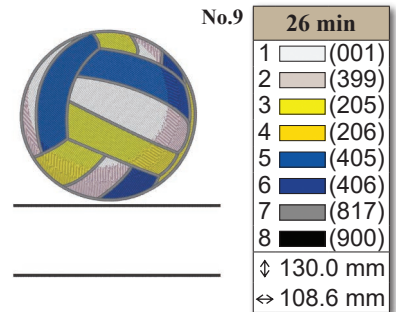
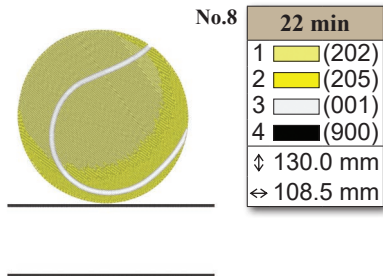
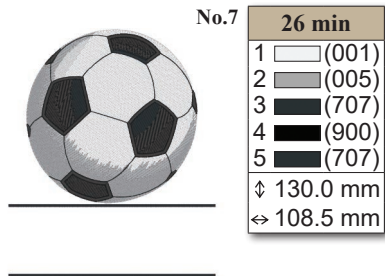

- ❁ Baby Lock "Exclusives" Variety designs
- ❁ Diseños Variety "Exclusivos" de Baby Lock
- ❁ Motifs Variété « exclusifs » Baby Lock

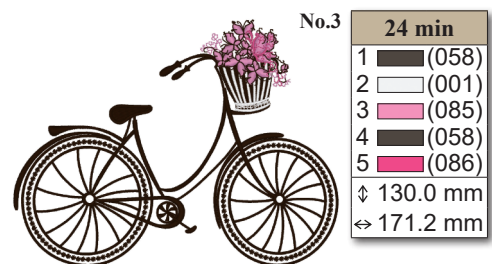
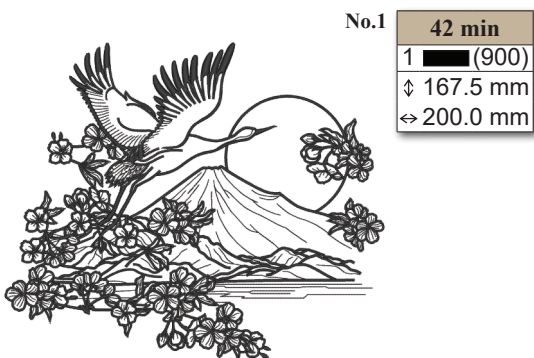
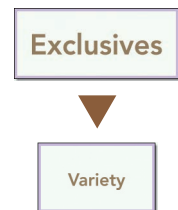

30 min					
1	(612)	9	(010)	17	(517)
2	(620)	10	(812)	18	(519)
3	(613)	11	(001)	19	(085)
4	(843)	12	(017)	20	(086)
5	(348)	13	(058)	21	(107)
6	(323)	14	(027)	22	(812)
7	(817)	15	(515)		
8	(704)	16	(808)		
↓ 130.0 mm ↔ 143.5 mm					

Embroidery Designs Color Change Table
Tabla de cambios de color para diseños de bordado
Tableau de changement de couleur des motifs de broderie

No.5

8 min	
1	(124)
2	(126)
3	(085)
4	(086)
5	(107)
↓ 100.0 mm	
↔ 75.9 mm	



No.6

8 min	
1	(124)
2	(085)
3	(126)
4	(086)
5	(107)
↓ 74.6 mm	
↔ 100.0 mm	



No.7

24 min	
1	(612)
2	(085)
3	(620)
4	(086)
5	(807)
6	(339)
7	(058)
↓ 168.7 mm	
↔ 130.0 mm	



No.8

8 min	
1	(027)
2	(517)
3	(124)
4	(085)
5	(086)
6	(107)
7	(027)
8	(339)
9	(517)
↓ 100.0 mm	
↔ 67.9 mm	



No.9

9 min	
1	(517)
2	(010)
3	(202)
4	(205)
5	(206)
6	(208)
7	(027)
8	(517)
↓ 100.0 mm	
↔ 59.4 mm	



53 min					
1	(085)	9	(086)	17	(107)
2	(086)	10	(704)	18	(612)
3	(807)	11	(707)	19	(620)
4	(107)	12	(612)	20	(614)
5	(614)	13	(620)	21	(704)
6	(612)	14	(085)	22	(707)
7	(620)	15	(086)		
8	(085)	16	(807)		
↓ 195.4 mm ↔ 237.6 mm					

No.11

18 min	
1	(810)
2	(620)
3	(869)
4	(613)
5	(517)
6	(519)
7	(509)
8	(515)
9	(808)
↓ 180.0 mm	
↔ 121.6 mm	



No.12

30 min			
1	(415)	9	(019)
2	(515)	10	(070)
3	(513)	11	(007)
4	(509)	12	(085)
5	(515)	13	(086)
6	(348)	14	(107)
7	(323)	15	(515)
8	(058)		
↓ 179.7 mm ↔ 124.8 mm			



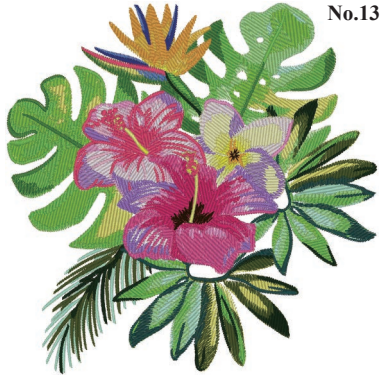

No.13

75 min		
1 (542)	11 (202)	21 (807)
2 (027)	12 (205)	22 (086)
3 (502)	13 (208)	23 (107)
4 (513)	14 (209)	24 (209)
5 (517)	15 (070)	25 (058)
6 (509)	16 (007)	26 (202)
7 (515)	17 (124)	27 (205)
8 (519)	18 (079)	28 (807)
9 (415)	19 (085)	
10 (010)	20 (612)	
↓ 195.6 mm ↔ 194.9 mm		



No.14

24 min	
1 (027)	
2 (515)	
3 (513)	
4 (509)	
5 (001)	
6 (019)	
7 (007)	
↓ 179.9 mm ↔ 107.8 mm	

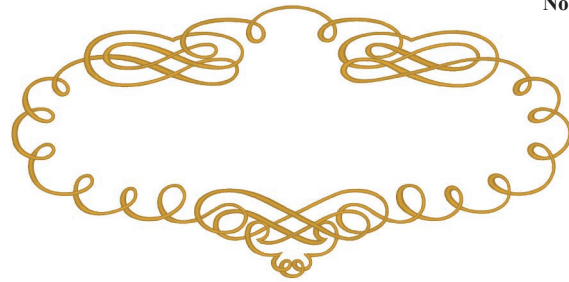

No.15

18 min	
1 (214)	
↓ 143.8 mm ↔ 295.4 mm	

Embroidery Designs Color Change Table
 Tabla de cambios de color para diseños de bordado
 Tableau de changement de couleur des motifs de broderie

- ✂ Embroidery designs
- ✂ Diseños de bordado
- ✂ Motifs de broderie



No.1 **14 min**

1	█ (900)
↓	84.8 mm
↔	131.1 mm

No.2 **15 min**

1	█ (613)
2	█ (086)
3	█ (070)
4	█ (613)
5	█ (070)
6	█ (534)
↓	162.0 mm
↔	255.3 mm

No.3 **7 min**

1	█ (328)
2	█ (330)
↓	85.5 mm
↔	94.8 mm

No.4 **31 min**

1	█ (085)
↓	152.0 mm
↔	185.1 mm

No.5 **30 min**

1	█ (542)
2	█ (085)
3	█ (812)
4	█ (620)
5	█ (030)
↓	194.6 mm
↔	276.9 mm

No.6 **6 min**

1	█ (542)
2	█ (812)
3	█ (030)
↓	147.2 mm
↔	44.2 mm

No.7

113 min

1	█ (307)	17	█ (507)
2	█ (900)	18	█ (085)
3	█ (307)	19	█ (807)
4	█ (807)	20	█ (085)
5	█ (513)	21	█ (807)
6	█ (507)	22	█ (085)
7	█ (513)	23	█ (307)
8	█ (507)	24	█ (807)
9	█ (513)	25	█ (513)
10	█ (507)	26	█ (507)
11	█ (807)	27	█ (807)
12	█ (513)	28	█ (507)
13	█ (507)	29	█ (513)
14	█ (513)	30	█ (085)
15	█ (507)	31	█ (807)
16	█ (513)	32	█ (085)
↓	183.2 mm	↔	277.5 mm

No.8 **15 min**

1	█ (534)
2	█ (030)
3	█ (208)
↓	98.8 mm
↔	109.7 mm

No.9 **1 min**

1	█ (900)
↓	24.4 mm
↔	95.7 mm

No.10 **1 min**

1	█ (900)
↓	18.9 mm
↔	62.7 mm

No.11 **1 min**

1	█ (900)
↓	23.8 mm
↔	58.5 mm

No.12 **1 min**

1	█ (900)
↓	40.6 mm
↔	74.9 mm

No.13 **1 min**

1	█ (900)
↓	15.2 mm
↔	62.9 mm

No.14 **3 min**

1	█ (900)
↓	24.7 mm
↔	129.1 mm

No.15



2 min	
1	(900)
↓	8.1 mm
↔	182.8 mm

No.19



14 min	
1	(328)
↓	137.6 mm
↔	147.2 mm

No.24



2 min	
1	(007)
↓	16.8 mm
↔	92.6 mm

No.16



19 min	
1	(399)
2	(804)
↓	186.8 mm
↔	160.1 mm

No.20



7 min				
1	(900)	3	(086)	
2	(085)	4	(807)	
↓	47.9 mm		↔	161.3 mm

No.25



1 min	
1	(005)
↓	20.7 mm
↔	33.7 mm

No.26



4 min	
1	(107)
2	(007)
3	(005)
4	(007)
5	(107)
↓	40.1 mm
↔	41.3 mm

No.21

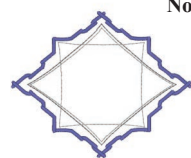

4 min	
1	(005)
2	(817)
3	(607)
↓	77.3 mm
↔	95.1 mm

No.27



2 min	
1	(812)
2	(205)
↓	32.1 mm
↔	30.2 mm

No.17



12 min	
1	(399)
2	(804)
↓	84.6 mm
↔	143.0 mm

No.22



2 min	
1	(328)
↓	47.9 mm
↔	51.4 mm

No.28



1 min	
1	(612)
2	(515)
3	(534)
4	(620)
↓	28.2 mm
↔	27.4 mm

No.18



10 min	
1	(399)
2	(804)
↓	48.4 mm
↔	188.5 mm

No.23















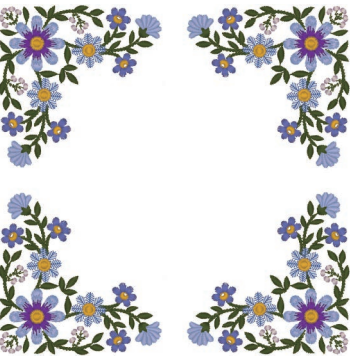

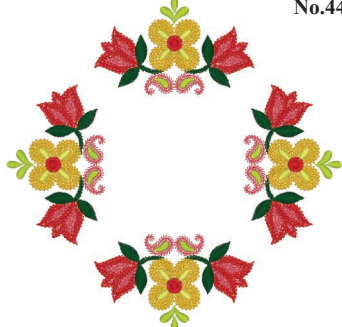

1 min	
1	(869)
↓	26.0 mm
↔	57.0 mm

No.29

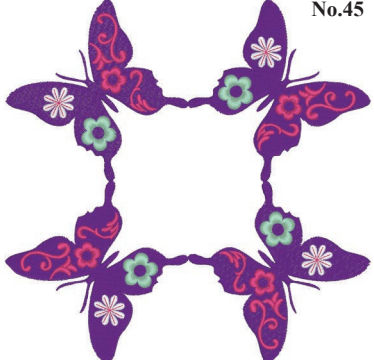

1 min	
1	(079)
2	(001)
3	(058)
↓	19.1 mm
↔	29.3 mm

Embroidery Designs Color Change Table
Tabla de cambios de color para diseños de bordado
Tableau de changement de couleur des motifs de broderie

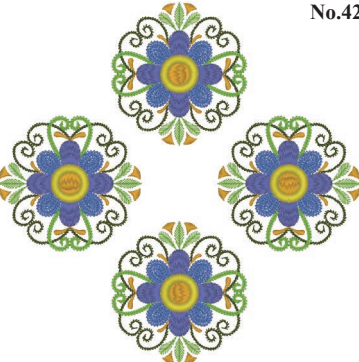
<p>No.30</p>  <table border="1"> <tr><th colspan="2">2 min</th></tr> <tr><td>1</td><td>(509)</td></tr> <tr><td>2</td><td>(515)</td></tr> <tr><td>↓</td><td>26.3 mm</td></tr> <tr><td>↔</td><td>26.6 mm</td></tr> </table>	2 min		1	(509)	2	(515)	↓	26.3 mm	↔	26.6 mm	<p>No.36</p>  <table border="1"> <tr><th colspan="2">2 min</th></tr> <tr><td>1</td><td>(001)</td></tr> <tr><td>2</td><td>(515)</td></tr> <tr><td>3</td><td>(800)</td></tr> <tr><td>4</td><td>(214)</td></tr> <tr><td>5</td><td>(001)</td></tr> <tr><td>↓</td><td>31.0 mm</td></tr> <tr><td>↔</td><td>30.9 mm</td></tr> </table>	2 min		1	(001)	2	(515)	3	(800)	4	(214)	5	(001)	↓	31.0 mm	↔	30.9 mm	<p>No.43</p>  <table border="1"> <tr><th colspan="2">36 min</th></tr> <tr><td>1</td><td>(399)</td></tr> <tr><td>2</td><td>(517)</td></tr> <tr><td>3</td><td>(607)</td></tr> <tr><td>4</td><td>(070)</td></tr> <tr><td>5</td><td>(804)</td></tr> <tr><td>6</td><td>(613)</td></tr> <tr><td>7</td><td>(214)</td></tr> <tr><td>8</td><td>(399)</td></tr> <tr><td>9</td><td>(517)</td></tr> <tr><td>10</td><td>(607)</td></tr> <tr><td>11</td><td>(070)</td></tr> <tr><td>12</td><td>(804)</td></tr> <tr><td>13</td><td>(613)</td></tr> <tr><td>14</td><td>(214)</td></tr> <tr><td>↓</td><td>185.9 mm</td></tr> <tr><td>↔</td><td>185.9 mm</td></tr> </table>	36 min		1	(399)	2	(517)	3	(607)	4	(070)	5	(804)	6	(613)	7	(214)	8	(399)	9	(517)	10	(607)	11	(070)	12	(804)	13	(613)	14	(214)	↓	185.9 mm	↔	185.9 mm																											
2 min																																																																																									
1	(509)																																																																																								
2	(515)																																																																																								
↓	26.3 mm																																																																																								
↔	26.6 mm																																																																																								
2 min																																																																																									
1	(001)																																																																																								
2	(515)																																																																																								
3	(800)																																																																																								
4	(214)																																																																																								
5	(001)																																																																																								
↓	31.0 mm																																																																																								
↔	30.9 mm																																																																																								
36 min																																																																																									
1	(399)																																																																																								
2	(517)																																																																																								
3	(607)																																																																																								
4	(070)																																																																																								
5	(804)																																																																																								
6	(613)																																																																																								
7	(214)																																																																																								
8	(399)																																																																																								
9	(517)																																																																																								
10	(607)																																																																																								
11	(070)																																																																																								
12	(804)																																																																																								
13	(613)																																																																																								
14	(214)																																																																																								
↓	185.9 mm																																																																																								
↔	185.9 mm																																																																																								
<p>No.31</p>  <table border="1"> <tr><th colspan="2">1 min</th></tr> <tr><td>1</td><td>(399)</td></tr> <tr><td>2</td><td>(348)</td></tr> <tr><td>↓</td><td>31.2 mm</td></tr> <tr><td>↔</td><td>21.1 mm</td></tr> </table>	1 min		1	(399)	2	(348)	↓	31.2 mm	↔	21.1 mm	<p>No.37</p>  <table border="1"> <tr><th colspan="2">7 min</th></tr> <tr><td>1</td><td>(005)</td></tr> <tr><td>↓</td><td>68.2 mm</td></tr> <tr><td>↔</td><td>53.8 mm</td></tr> </table>	7 min		1	(005)	↓	68.2 mm	↔	53.8 mm																																																																						
1 min																																																																																									
1	(399)																																																																																								
2	(348)																																																																																								
↓	31.2 mm																																																																																								
↔	21.1 mm																																																																																								
7 min																																																																																									
1	(005)																																																																																								
↓	68.2 mm																																																																																								
↔	53.8 mm																																																																																								
<p>No.32</p>  <table border="1"> <tr><th colspan="2">1 min</th></tr> <tr><td>1</td><td>(328)</td></tr> <tr><td>2</td><td>(214)</td></tr> <tr><td>↓</td><td>37.6 mm</td></tr> <tr><td>↔</td><td>15.3 mm</td></tr> </table>	1 min		1	(328)	2	(214)	↓	37.6 mm	↔	15.3 mm	<p>No.38</p>  <table border="1"> <tr><th colspan="2">2 min</th></tr> <tr><td>1</td><td>(214)</td></tr> <tr><td>↓</td><td>39.3 mm</td></tr> <tr><td>↔</td><td>38.4 mm</td></tr> </table>	2 min		1	(214)	↓	39.3 mm	↔	38.4 mm	<p>No.44</p>  <table border="1"> <tr><th colspan="2">29 min</th></tr> <tr><td>1</td><td>(513)</td></tr> <tr><td>2</td><td>(085)</td></tr> <tr><td>3</td><td>(807)</td></tr> <tr><td>4</td><td>(507)</td></tr> <tr><td>5</td><td>(209)</td></tr> <tr><td>6</td><td>(206)</td></tr> <tr><td>7</td><td>(807)</td></tr> <tr><td>↓</td><td>177.3 mm</td></tr> <tr><td>↔</td><td>177.4 mm</td></tr> </table>	29 min		1	(513)	2	(085)	3	(807)	4	(507)	5	(209)	6	(206)	7	(807)	↓	177.3 mm	↔	177.4 mm																																																	
1 min																																																																																									
1	(328)																																																																																								
2	(214)																																																																																								
↓	37.6 mm																																																																																								
↔	15.3 mm																																																																																								
2 min																																																																																									
1	(214)																																																																																								
↓	39.3 mm																																																																																								
↔	38.4 mm																																																																																								
29 min																																																																																									
1	(513)																																																																																								
2	(085)																																																																																								
3	(807)																																																																																								
4	(507)																																																																																								
5	(209)																																																																																								
6	(206)																																																																																								
7	(807)																																																																																								
↓	177.3 mm																																																																																								
↔	177.4 mm																																																																																								
<p>No.33</p>  <table border="1"> <tr><th colspan="2">1 min</th></tr> <tr><td>1</td><td>(001)</td></tr> <tr><td>2</td><td>(509)</td></tr> <tr><td>3</td><td>(058)</td></tr> <tr><td>↓</td><td>29.9 mm</td></tr> <tr><td>↔</td><td>23.8 mm</td></tr> </table>	1 min		1	(001)	2	(509)	3	(058)	↓	29.9 mm	↔	23.8 mm	<p>No.39</p>  <table border="1"> <tr><th colspan="2">6 min</th></tr> <tr><td>1</td><td>(214)</td></tr> <tr><td>↓</td><td>68.5 mm</td></tr> <tr><td>↔</td><td>69.5 mm</td></tr> </table>	6 min		1	(214)	↓	68.5 mm	↔	69.5 mm																																																																				
1 min																																																																																									
1	(001)																																																																																								
2	(509)																																																																																								
3	(058)																																																																																								
↓	29.9 mm																																																																																								
↔	23.8 mm																																																																																								
6 min																																																																																									
1	(214)																																																																																								
↓	68.5 mm																																																																																								
↔	69.5 mm																																																																																								
<p>No.34</p>  <table border="1"> <tr><th colspan="2">1 min</th></tr> <tr><td>1</td><td>(900)</td></tr> <tr><td>2</td><td>(800)</td></tr> <tr><td>3</td><td>(900)</td></tr> <tr><td>↓</td><td>15.0 mm</td></tr> <tr><td>↔</td><td>16.1 mm</td></tr> </table>	1 min		1	(900)	2	(800)	3	(900)	↓	15.0 mm	↔	16.1 mm	<p>No.40</p>  <table border="1"> <tr><th colspan="2">4 min</th></tr> <tr><td>1</td><td>(348)</td></tr> <tr><td>2</td><td>(399)</td></tr> <tr><td>3</td><td>(085)</td></tr> <tr><td>4</td><td>(124)</td></tr> <tr><td>↓</td><td>41.4 mm</td></tr> <tr><td>↔</td><td>49.3 mm</td></tr> </table>	4 min		1	(348)	2	(399)	3	(085)	4	(124)	↓	41.4 mm	↔	49.3 mm	<p>No.45</p> 																																																													
1 min																																																																																									
1	(900)																																																																																								
2	(800)																																																																																								
3	(900)																																																																																								
↓	15.0 mm																																																																																								
↔	16.1 mm																																																																																								
4 min																																																																																									
1	(348)																																																																																								
2	(399)																																																																																								
3	(085)																																																																																								
4	(124)																																																																																								
↓	41.4 mm																																																																																								
↔	49.3 mm																																																																																								
<p>No.35</p>  <table border="1"> <tr><th colspan="2">10 min</th></tr> <tr><td>1</td><td>(307)</td></tr> <tr><td>2</td><td>(517)</td></tr> <tr><td>3</td><td>(513)</td></tr> <tr><td>4</td><td>(515)</td></tr> <tr><td>5</td><td>(612)</td></tr> <tr><td>6</td><td>(807)</td></tr> <tr><td>7</td><td>(517)</td></tr> <tr><td>8</td><td>(812)</td></tr> <tr><td>↓</td><td>74.3 mm</td></tr> <tr><td>↔</td><td>75.8 mm</td></tr> </table>	10 min		1	(307)	2	(517)	3	(513)	4	(515)	5	(612)	6	(807)	7	(517)	8	(812)	↓	74.3 mm	↔	75.8 mm	<p>No.42</p>  <table border="1"> <tr><th colspan="2">39 min</th></tr> <tr><td>1</td><td>(517)</td></tr> <tr><td>2</td><td>(214)</td></tr> <tr><td>3</td><td>(513)</td></tr> <tr><td>4</td><td>(070)</td></tr> <tr><td>5</td><td>(607)</td></tr> <tr><td>6</td><td>(214)</td></tr> <tr><td>7</td><td>(206)</td></tr> <tr><td>↓</td><td>192.5 mm</td></tr> <tr><td>↔</td><td>192.5 mm</td></tr> </table>	39 min		1	(517)	2	(214)	3	(513)	4	(070)	5	(607)	6	(214)	7	(206)	↓	192.5 mm	↔	192.5 mm	<table border="1"> <tr><th colspan="3">41 min</th></tr> <tr><td>1</td><td>(613)</td><td>7</td><td>(086)</td><td>13</td><td>(613)</td></tr> <tr><td>2</td><td>(001)</td><td>8</td><td>(542)</td><td>14</td><td>(001)</td></tr> <tr><td>3</td><td>(086)</td><td>9</td><td>(613)</td><td>15</td><td>(086)</td></tr> <tr><td>4</td><td>(542)</td><td>10</td><td>(001)</td><td>16</td><td>(542)</td></tr> <tr><td>5</td><td>(613)</td><td>11</td><td>(086)</td><td></td><td></td></tr> <tr><td>6</td><td>(001)</td><td>12</td><td>(542)</td><td></td><td></td></tr> <tr><td>↓</td><td colspan="2">194.0 mm</td><td colspan="2">↔</td><td>194.0 mm</td></tr> </table>	41 min			1	(613)	7	(086)	13	(613)	2	(001)	8	(542)	14	(001)	3	(086)	9	(613)	15	(086)	4	(542)	10	(001)	16	(542)	5	(613)	11	(086)			6	(001)	12	(542)			↓	194.0 mm		↔		194.0 mm
10 min																																																																																									
1	(307)																																																																																								
2	(517)																																																																																								
3	(513)																																																																																								
4	(515)																																																																																								
5	(612)																																																																																								
6	(807)																																																																																								
7	(517)																																																																																								
8	(812)																																																																																								
↓	74.3 mm																																																																																								
↔	75.8 mm																																																																																								
39 min																																																																																									
1	(517)																																																																																								
2	(214)																																																																																								
3	(513)																																																																																								
4	(070)																																																																																								
5	(607)																																																																																								
6	(214)																																																																																								
7	(206)																																																																																								
↓	192.5 mm																																																																																								
↔	192.5 mm																																																																																								
41 min																																																																																									
1	(613)	7	(086)	13	(613)																																																																																				
2	(001)	8	(542)	14	(001)																																																																																				
3	(086)	9	(613)	15	(086)																																																																																				
4	(542)	10	(001)	16	(542)																																																																																				
5	(613)	11	(086)																																																																																						
6	(001)	12	(542)																																																																																						
↓	194.0 mm		↔		194.0 mm																																																																																				

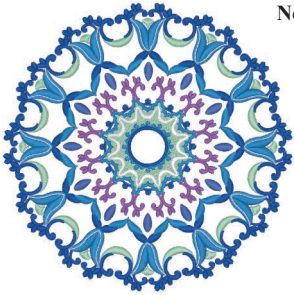

No.46

36 min			
1	(612)	7	(542)
2	(405)	8	(405)
3	(542)	9	(019)
4	(001)	10	(001)
5	(019)	11	(070)
6	(405)		

↓ 153.0 mm ↔ 153.5 mm



No.49

23 min	
1	(107)
2	(086)

↓ 148.2 mm
↔ 195.4 mm



No.47



No.50

22 min	
1	(405)
2	(420)

↓ 148.2 mm
↔ 195.4 mm



No.51

22 min	
1	(517)
2	(515)

↓ 148.2 mm
↔ 195.4 mm

51 min					
1	(515)	15	(019)	29	(010)
2	(027)	16	(208)	30	(323)
3	(513)	17	(843)	31	(513)
4	(058)	18	(010)	32	(534)
5	(208)	19	(810)	33	(019)
6	(070)	20	(010)	34	(208)
7	(019)	21	(323)	35	(843)
8	(209)	22	(513)	36	(010)
9	(208)	23	(534)	37	(810)
10	(800)	24	(019)	38	(010)
11	(405)	25	(208)	39	(323)
12	(058)	26	(843)	40	(513)
13	(513)	27	(010)	41	(534)
14	(534)	28	(810)	42	(019)
				43	(208)
				44	(843)
				45	(010)
				46	(810)
				47	(010)
				48	(323)
				49	(070)
				50	(208)
				51	(001)
				52	(058)
				53	(010)
				54	(070)
				55	(058)
				56	(620)

↓ 195.8 mm ↔ 195.8 mm



No.52

22 min	
1	(007)
2	(405)

↓ 148.2 mm
↔ 195.4 mm

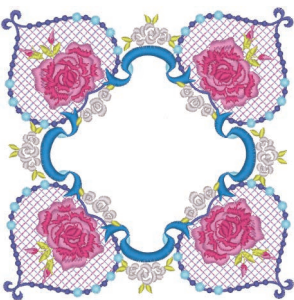

No.48

37 min	
1	(804)
2	(810)
3	(607)
4	(017)
5	(019)
6	(085)
7	(086)
8	(027)
9	(124)

↓ 156.0 mm
↔ 155.1 mm



No.53

56 min			
1	(208)	12	(307)
2	(323)	13	(126)
3	(126)	14	(333)
4	(058)	15	(208)
5	(800)	16	(126)
6	(107)	17	(001)
7	(058)	18	(800)
8	(001)	19	(058)
9	(126)	20	(107)
10	(399)	21	(399)
11	(107)	22	(058)

↓ 194.3 mm ↔ 145.2 mm

Embroidery Designs Color Change Table
Tabla de cambios de color para diseños de bordado
Tableau de changement de couleur des motifs de broderie

No.54 **42 min**



1	(208)
2	(900)
3	(620)
4	(339)
5	(900)
↓ 182.7 mm	
↔ 194.7 mm	

No.60 **3 min**

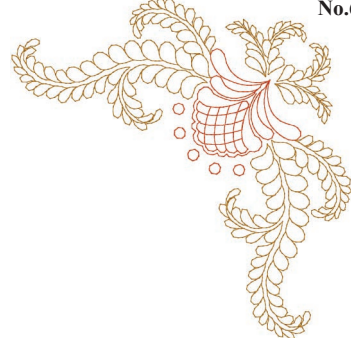

1	(030)
2	(323)
↓ 181.2 mm	
↔ 180.4 mm	

No.55 **51 min**



1	(420)
2	(515)
3	(206)
4	(420)
5	(007)
6	(800)
7	(515)
8	(206)
9	(007)
10	(005)
11	(420)
12	(800)
↓ 192.2 mm	
↔ 184.1 mm	

No.61 **23 min**

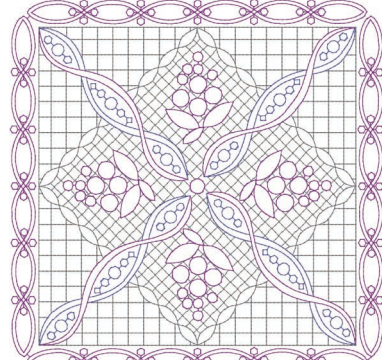

1	(817)
2	(620)
3	(817)
4	(620)
5	(607)
6	(817)
7	(620)
8	(607)
9	(817)
10	(620)
11	(607)
12	(620)
↓ 199.0 mm	
↔ 199.0 mm	

No.56 **10 min**



1	(399)
2	(001)
↓ 85.5 mm	
↔ 56.0 mm	

No.59



11 min

1	(209)	6	(339)
2	(206)	7	(323)
3	(209)	8	(001)
4	(900)	9	(843)
5	(206)	10	(900)
↓ 55.2 mm ↔ 118.9 mm			

No.62 **1 min**

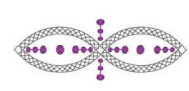

1	(817)
2	(620)
↓ 32.2 mm	
↔ 91.0 mm	

No.57 **4 min**



1	(328)
↓ 74.1 mm	
↔ 54.1 mm	

No.63 **10 min**

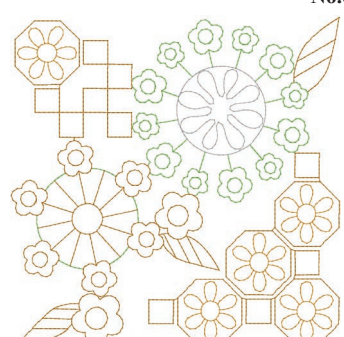

1	(509)
2	(005)
3	(323)
4	(209)
↓ 173.6 mm	
↔ 174.0 mm	

No.58 **3 min**



1	(328)
2	(348)
↓ 42.4 mm	
↔ 40.1 mm	



No.64

2 min	
1	(323)
2	(509)
↓	180.9 mm
↔	45.3 mm



No.65

3 min	
1	(517)
2	(208)
3	(800)
↓	123.9 mm
↔	59.4 mm



No.66

3 min	
1	(214)
2	(330)
↓	95.3 mm
↔	83.5 mm



No.67

2 min	
1	(330)
↓	44.2 mm
↔	162.8 mm



No.68

11 min	
1	(107)
2	(005)
3	(415)
4	(214)
↓	188.7 mm
↔	191.2 mm

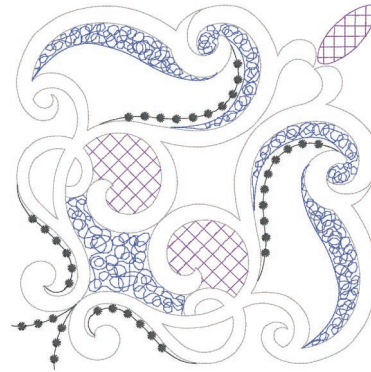

No.69

12 min	
1	(005)
2	(070)
3	(704)
4	(612)
↓	194.2 mm
↔	194.2 mm

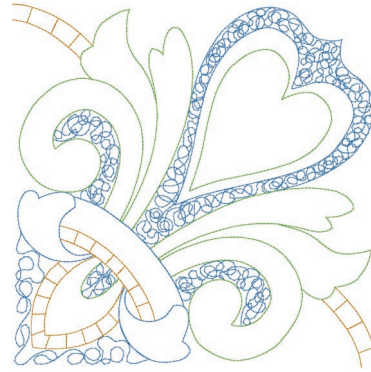

No.70

13 min	
1	(019)
2	(509)
3	(209)
4	(019)
5	(509)
↓	193.2 mm
↔	193.6 mm

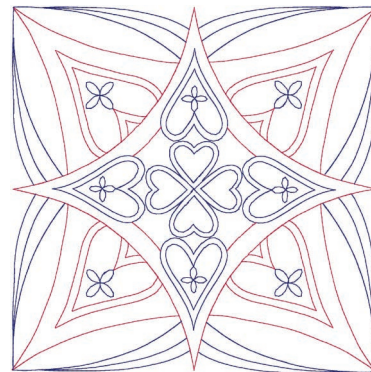

No.71

7 min	
1	(107)
2	(007)
3	(107)
↓	194.4 mm
↔	193.6 mm

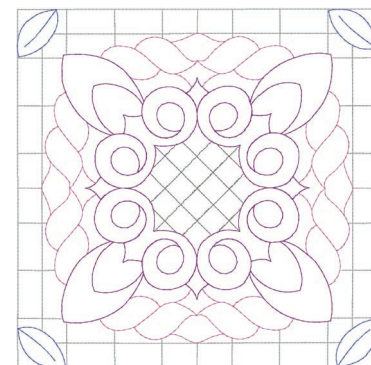

No.72

13 min	
1	(817)
2	(005)
3	(810)
4	(620)
5	(070)
↓	191.2 mm
↔	191.2 mm

Embroidery Designs Color Change Table
 Tabla de cambios de color para diseños de bordado
 Tableau de changement de couleur des motifs de broderie

✦ Alphabet

✦ Alfabeto

✦ Alphabet

- Vintage
- Antiguo
- Classique



<p>No.1 17 min 1  (323) ↓ 148.0 mm ↔ 129.6 mm</p> 	<p>No.6 16 min 1  (323) ↓ 149.3 mm ↔ 107.4 mm</p> 	<p>No.11 21 min 1  (323) ↓ 149.4 mm ↔ 125.1 mm</p> 
<p>No.2 18 min 1  (323) ↓ 149.9 mm ↔ 110.9 mm</p> 	<p>No.7 18 min 1  (323) ↓ 150.4 mm ↔ 111.7 mm</p> 	<p>No.12 13 min 1  (323) ↓ 149.2 mm ↔ 107.1 mm</p> 
<p>No.3 14 min 1  (323) ↓ 152.9 mm ↔ 102.3 mm</p> 	<p>No.8 21 min 1  (323) ↓ 149.1 mm ↔ 125.6 mm</p> 	<p>No.13 28 min 1  (323) ↓ 149.2 mm ↔ 150.1 mm</p> 
<p>No.4 18 min 1  (323) ↓ 149.3 mm ↔ 111.7 mm</p> 	<p>No.9 10 min 1  (323) ↓ 149.1 mm ↔ 58.0 mm</p> 	<p>No.14 21 min 1  (323) ↓ 149.7 mm ↔ 131.1 mm</p> 
<p>No.5 19 min 1  (323) ↓ 149.1 mm ↔ 109.7 mm</p> 	<p>No.10 11 min 1  (323) ↓ 148.8 mm ↔ 93.9 mm</p> 	<p>No.15 19 min 1  (323) ↓ 151.7 mm ↔ 107.1 mm</p> 

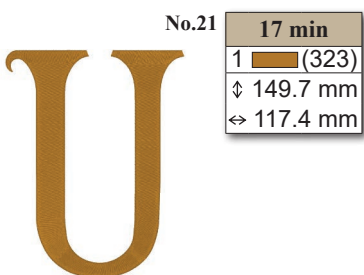
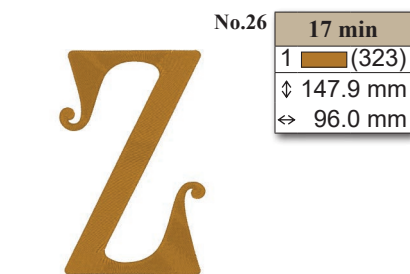
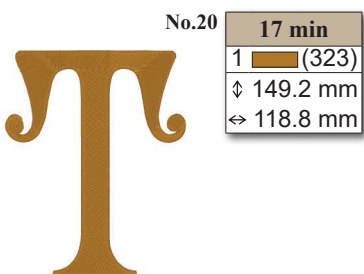
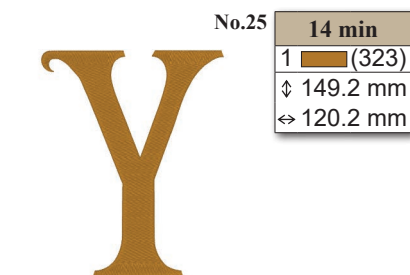
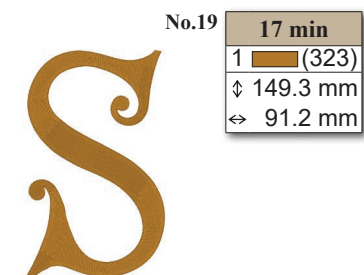
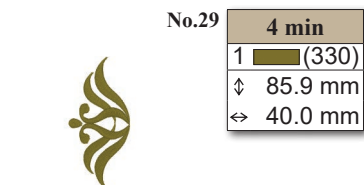
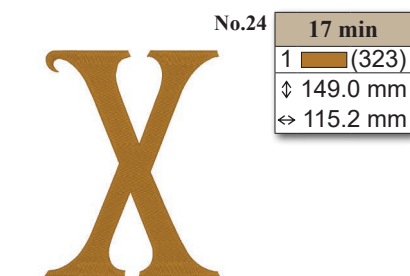
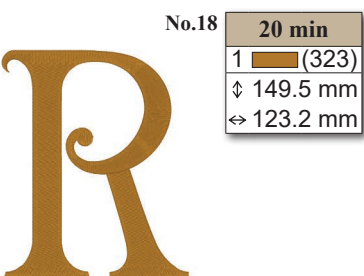
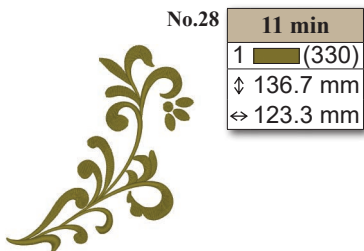
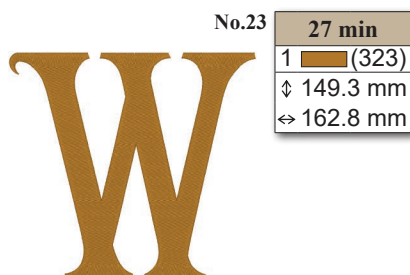
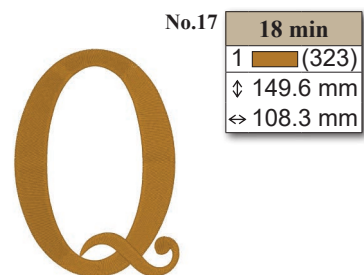
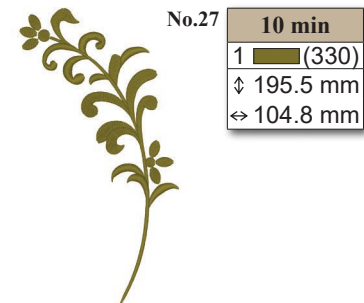
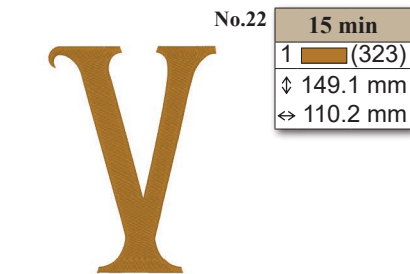
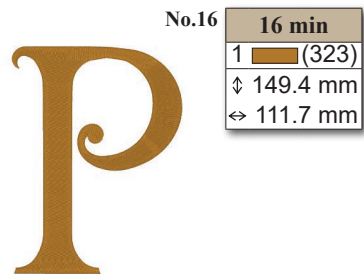

Embroidery Designs Color Change Table
 Tabla de cambios de color para diseños de bordado
 Tableau de changement de couleur des motifs de broderie

- Floral
- Floral
- Floral



	<p>No.1</p> <p>17 min</p> <p>1 (328) 2 (804) 3 (612) 4 (079) 5 (807) 6 (513) 7 (502)</p> <p>↓ 145.1 mm ↔ 125.7 mm</p>		<p>No.6</p> <p>16 min</p> <p>1 (328) 2 (804) 3 (612) 4 (079) 5 (807) 6 (513) 7 (502)</p> <p>↓ 142.8 mm ↔ 101.8 mm</p>		<p>No.11</p> <p>20 min</p> <p>1 (328) 2 (804) 3 (612) 4 (079) 5 (807) 6 (513) 7 (502)</p> <p>↓ 142.0 mm ↔ 119.6 mm</p>
	<p>No.2</p> <p>20 min</p> <p>1 (328) 2 (804) 3 (612) 4 (079) 5 (807) 6 (513) 7 (502)</p> <p>↓ 140.9 mm ↔ 108.1 mm</p>		<p>No.7</p> <p>19 min</p> <p>1 (328) 2 (804) 3 (612) 4 (079) 5 (807) 6 (513) 7 (502)</p> <p>↓ 141.6 mm ↔ 117.3 mm</p>		<p>No.12</p> <p>15 min</p> <p>1 (328) 2 (804) 3 (612) 4 (079) 5 (807) 6 (513) 7 (502)</p> <p>↓ 144.9 mm ↔ 107.0 mm</p>
	<p>No.3</p> <p>17 min</p> <p>1 (328) 2 (804) 3 (612) 4 (079) 5 (807) 6 (513) 7 (502)</p> <p>↓ 141.8 mm ↔ 114.5 mm</p>		<p>No.8</p> <p>22 min</p> <p>1 (328) 2 (804) 3 (612) 4 (079) 5 (807) 6 (513) 7 (502)</p> <p>↓ 141.7 mm ↔ 121.6 mm</p>		<p>No.13</p> <p>23 min</p> <p>1 (328) 2 (804) 3 (612) 4 (079) 5 (807) 6 (513) 7 (502)</p> <p>↓ 146.5 mm ↔ 124.6 mm</p>
	<p>No.4</p> <p>19 min</p> <p>1 (328) 2 (804) 3 (612) 4 (079) 5 (807) 6 (513) 7 (502)</p> <p>↓ 141.2 mm ↔ 108.3 mm</p>		<p>No.9</p> <p>14 min</p> <p>1 (328) 2 (804) 3 (612) 4 (079) 5 (807) 6 (513) 7 (502)</p> <p>↓ 145.8 mm ↔ 49.7 mm</p>		<p>No.14</p> <p>20 min</p> <p>1 (328) 2 (804) 3 (612) 4 (079) 5 (807) 6 (513) 7 (502)</p> <p>↓ 147.0 mm ↔ 116.8 mm</p>
	<p>No.5</p> <p>18 min</p> <p>1 (328) 2 (804) 3 (612) 4 (079) 5 (807) 6 (513) 7 (502)</p> <p>↓ 144.3 mm ↔ 102.5 mm</p>		<p>No.10</p> <p>15 min</p> <p>1 (328) 2 (804) 3 (612) 4 (079) 5 (807) 6 (513) 7 (502)</p> <p>↓ 144.5 mm ↔ 82.3 mm</p>		<p>No.15</p> <p>19 min</p> <p>1 (328) 2 (804) 3 (612) 4 (079) 5 (807) 6 (513) 7 (502)</p> <p>↓ 146.3 mm ↔ 115.3 mm</p>



No.16

17 min	
1	(328)
2	(804)
3	(612)
4	(079)
5	(807)
6	(513)
7	(502)
↓	143.4 mm
↔	99.6 mm



No.20

18 min	
1	(328)
2	(804)
3	(612)
4	(079)
5	(807)
6	(513)
7	(502)
↓	144.5 mm
↔	118.4 mm



No.24

19 min	
1	(328)
2	(804)
3	(612)
4	(079)
5	(807)
6	(513)
7	(502)
↓	142.3 mm
↔	115.9 mm



No.17

20 min	
1	(328)
2	(804)
3	(612)
4	(079)
5	(807)
6	(513)
7	(502)
↓	142.7 mm
↔	118.2 mm



No.21

18 min	
1	(328)
2	(804)
3	(612)
4	(079)
5	(807)
6	(513)
7	(502)
↓	144.6 mm
↔	118.5 mm



No.25

17 min	
1	(328)
2	(804)
3	(612)
4	(079)
5	(807)
6	(513)
7	(502)
↓	142.8 mm
↔	116.3 mm



No.18

21 min	
1	(328)
2	(804)
3	(612)
4	(079)
5	(807)
6	(513)
7	(502)
↓	143.4 mm
↔	112.5 mm



No.22

17 min	
1	(328)
2	(804)
3	(612)
4	(079)
5	(807)
6	(513)
7	(502)
↓	145.5 mm
↔	121.5 mm



No.26

19 min	
1	(328)
2	(804)
3	(612)
4	(079)
5	(807)
6	(513)
7	(502)
↓	142.8 mm
↔	92.9 mm



No.19

21 min	
1	(328)
2	(804)
3	(612)
4	(079)
5	(807)
6	(513)
7	(502)
↓	144.1 mm
↔	99.4 mm



No.23

23 min	
1	(328)
2	(804)
3	(612)
4	(079)
5	(807)
6	(513)
7	(502)
↓	146.2 mm
↔	124.8 mm

◆Example ◆Ejemplo ◆Exemple

19 min	
1	(328)
2	(804)
3	(612)
4	(079)
5	(807)
6	(513)
7	(502)
↓	142.8 mm
↔	92.9 mm



No.27

3 min	
1	(328)
2	(079)
3	(807)
4	(513)
5	(502)
↓	51.9 mm
↔	45.9 mm



No.29

3 min	
1	(328)
2	(079)
3	(807)
4	(513)
5	(502)
↓	52.2 mm
↔	41.1 mm



No.31

3 min	
1	(328)
2	(079)
3	(807)
4	(513)
5	(502)
↓	53.1 mm
↔	37.3 mm



No.28

3 min	
1	(328)
2	(079)
3	(807)
4	(513)
5	(502)
↓	51.7 mm
↔	39.6 mm



No.30

3 min	
1	(328)
2	(079)
3	(807)
4	(513)
5	(502)
↓	51.9 mm
↔	39.3 mm



No.32

3 min	
1	(328)
2	(079)
3	(807)
4	(513)
5	(502)
↓	52.1 mm
↔	36.6 mm

Embroidery Designs Color Change Table
Tabla de cambios de color para diseños de bordado
Tableau de changement de couleur des motifs de broderie

No.33 **3 min**



1	(328)
2	(079)
3	(807)
4	(513)
5	(502)
↓	51.9 mm
↔	42.7 mm

No.38 **3 min**



1	(328)
2	(079)
3	(807)
4	(513)
5	(502)
↓	52.5 mm
↔	38.9 mm

No.43 **3 min**



1	(328)
2	(079)
3	(807)
4	(513)
5	(502)
↓	52.6 mm
↔	43.3 mm

No.48 **3 min**



1	(328)
2	(079)
3	(807)
4	(513)
5	(502)
↓	52.8 mm
↔	43.9 mm

No.34 **4 min**



1	(328)
2	(079)
3	(807)
4	(513)
5	(502)
↓	52.2 mm
↔	44.3 mm

No.39 **5 min**



1	(328)
2	(079)
3	(807)
4	(513)
5	(502)
↓	53.3 mm
↔	46.4 mm

No.44 **4 min**



1	(328)
2	(079)
3	(807)
4	(513)
5	(502)
↓	52.3 mm
↔	40.7 mm

No.49 **4 min**



1	(328)
2	(079)
3	(807)
4	(513)
5	(502)
↓	53.3 mm
↔	46.5 mm

No.35 **3 min**



1	(328)
2	(079)
3	(807)
4	(513)
5	(502)
↓	53.9 mm
↔	23.8 mm

No.40 **4 min**



1	(328)
2	(079)
3	(807)
4	(513)
5	(502)
↓	52.9 mm
↔	43.1 mm

No.45 **3 min**



1	(328)
2	(079)
3	(807)
4	(513)
5	(502)
↓	52.6 mm
↔	35.0 mm

No.50 **3 min**



1	(328)
2	(079)
3	(807)
4	(513)
5	(502)
↓	51.7 mm
↔	42.0 mm

No.36 **3 min**



1	(328)
2	(079)
3	(807)
4	(513)
5	(502)
↓	52.6 mm
↔	30.1 mm

No.41 **3 min**



1	(328)
2	(079)
3	(807)
4	(513)
5	(502)
↓	52.8 mm
↔	42.6 mm

No.46 **3 min**



1	(328)
2	(079)
3	(807)
4	(513)
5	(502)
↓	53.0 mm
↔	42.0 mm

No.51 **3 min**



1	(328)
2	(079)
3	(807)
4	(513)
5	(502)
↓	53.8 mm
↔	42.2 mm

No.37 **4 min**



1	(328)
2	(079)
3	(807)
4	(513)
5	(502)
↓	52.4 mm
↔	43.4 mm

No.42 **3 min**



1	(328)
2	(079)
3	(807)
4	(513)
5	(502)
↓	52.1 mm
↔	36.9 mm

No.47 **3 min**



1	(328)
2	(079)
3	(807)
4	(513)
5	(502)
↓	52.5 mm
↔	42.8 mm

No.52 **3 min**



1	(328)
2	(079)
3	(807)
4	(513)
5	(502)
↓	52.4 mm
↔	33.4 mm

No.53 **2 min**



1	(804)
2	(612)
3	(079)
4	(807)
5	(513)
6	(502)
↓	34.4 mm
↔	22.7 mm

No.55



3 min		
1	(804)	3 (079)
2	(612)	4 (807)
5	(513)	6 (502)
↓	39.3 mm ↔ 75.4 mm	

No.57



6 min					
1	(804)	7 (804)	13 (079)		
2	(612)	8 (612)	14 (807)		
3	(079)	9 (079)	15 (513)		
4	(807)	10 (807)	16 (502)		
5	(513)	11 (513)			
6	(502)	12 (502)			
↓	27.9 mm ↔ 121.9 mm				

No.54 **2 min**



1	(079)
2	(807)
3	(513)
4	(502)
↓	39.8 mm
↔	25.6 mm

No.56



6 min					
1	(804)	5 (513)	9 (079)		
2	(612)	6 (502)	10 (807)		
3	(079)	7 (804)	11 (513)		
4	(807)	8 (612)	12 (502)		
↓	23.4 mm ↔ 123.7 mm				



No. 58

11 min		
1 (079)	7 (513)	13 (079)
2 (807)	8 (502)	14 (807)
3 (513)	9 (079)	15 (513)
4 (502)	10 (807)	16 (502)
5 (079)	11 (513)	
6 (807)	12 (502)	
↓ 103.6 mm ↔ 94.9 mm		



No.60

4 min	
1 (513)	2 (807)
3 (513)	4 (807)
↓ 106.7 mm	
↔ 93.4 mm	



No.63

1 min
1 (513)
↓ 147.2 mm
↔ 61.8 mm



No.59

20 min		
1 (079)	17 (513)	33 (804)
2 (807)	18 (502)	34 (612)
3 (804)	19 (079)	35 (513)
4 (612)	20 (807)	36 (502)
5 (513)	21 (804)	37 (079)
6 (502)	22 (612)	38 (807)
7 (079)	23 (513)	39 (804)
8 (807)	24 (502)	40 (612)
9 (804)	25 (079)	41 (513)
10 (612)	26 (807)	42 (502)
11 (513)	27 (804)	43 (079)
12 (502)	28 (612)	44 (807)
13 (079)	29 (513)	45 (804)
14 (807)	30 (502)	46 (612)
15 (804)	31 (079)	47 (513)
16 (612)	32 (807)	48 (502)
↓ 195.4 mm ↔ 157.3 mm		



No.61

3 min	
1 (513)	2 (807)
3 (513)	4 (807)
↓ 42.6 mm	
↔ 142.0 mm	



No.64

7 min			
1 (804)	13 (804)	14 (612)	15 (079)
2 (612)	14 (612)	16 (807)	17 (513)
3 (079)	15 (079)	18 (502)	19 (804)
4 (807)	16 (807)	20 (612)	21 (079)
5 (513)	17 (513)	22 (807)	23 (513)
6 (502)	18 (502)	23 (513)	24 (502)
7 (804)	19 (804)	24 (502)	
8 (612)	20 (612)		
9 (079)	21 (079)		
10 (807)	22 (807)		
11 (513)	23 (513)		
12 (502)	24 (502)		
↓ 73.3 mm ↔ 72.8 mm			



No.62

11 min		
1 (513)	4 (807)	7 (513)
2 (807)	5 (513)	8 (807)
3 (513)	6 (807)	
↓ 195.4 mm ↔ 158.5 mm		

Embroidery Designs Color Change Table
 Tabla de cambios de color para diseños de bordado
 Tableau de changement de couleur des motifs de broderie

- Line
- Línea
- Ligne



No.1

L: 13 min S: 9 min	
1	■ (005)
2	■ (807)
↓ 125.1 mm	
L:	↔ 103.3 mm
↓ 95.9 mm	
S:	↔ 79.1 mm



No.4

L: 14 min S: 10 min	
1	■ (005)
2	■ (807)
↓ 124.8 mm	
L:	↔ 95.8 mm
↓ 95.8 mm	
S:	↔ 73.8 mm



No.7

L: 12 min S: 8 min	
1	■ (005)
2	■ (807)
↓ 125.0 mm	
L:	↔ 87.6 mm
↓ 95.8 mm	
S:	↔ 67.2 mm



No.2

L: 13 min S: 9 min	
1	■ (005)
2	■ (807)
↓ 124.8 mm	
L:	↔ 86.6 mm
↓ 95.7 mm	
S:	↔ 66.4 mm



No.5

L: 14 min S: 10 min	
1	■ (005)
2	■ (807)
↓ 124.8 mm	
L:	↔ 87.8 mm
↓ 95.8 mm	
S:	↔ 67.4 mm



No.8

L: 15 min S: 10 min	
1	■ (005)
2	■ (807)
↓ 125.0 mm	
L:	↔ 89.8 mm
↓ 95.7 mm	
S:	↔ 68.8 mm



No.3

L: 11 min S: 8 min	
1	■ (005)
2	■ (807)
↓ 124.8 mm	
L:	↔ 85.6 mm
↓ 95.8 mm	
S:	↔ 65.8 mm



No.6

L: 13 min S: 9 min	
1	■ (005)
2	■ (807)
↓ 124.8 mm	
L:	↔ 80.6 mm
↓ 95.8 mm	
S:	↔ 61.8 mm









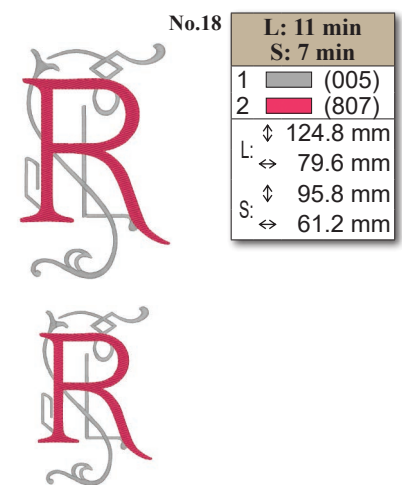
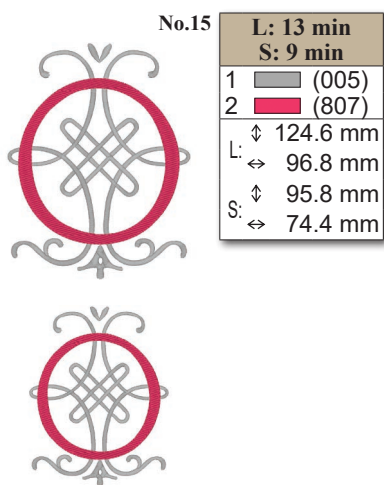
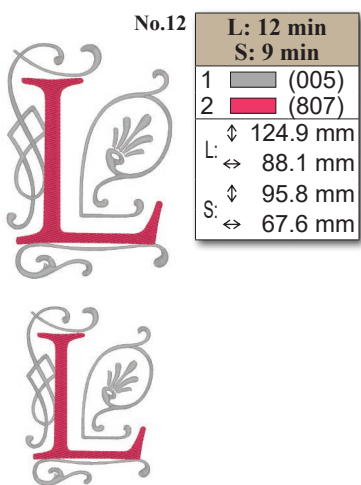
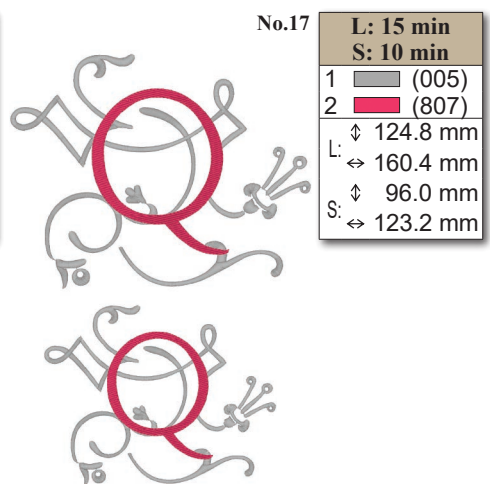
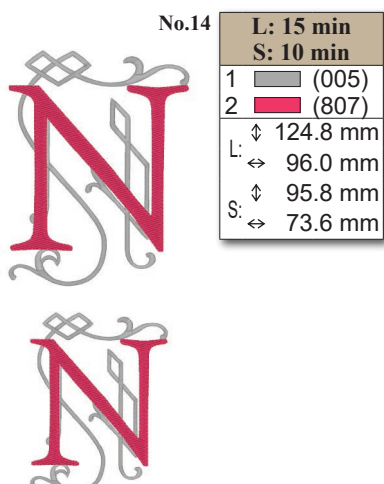
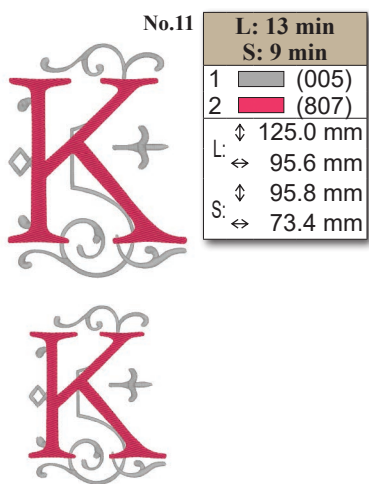
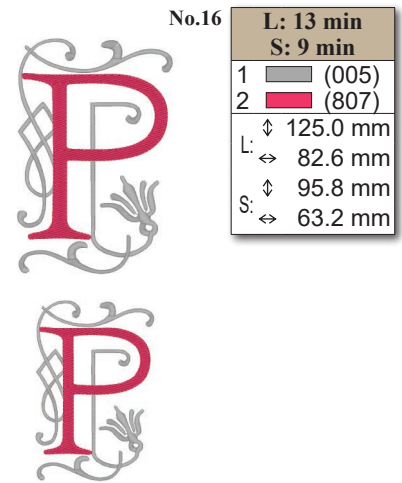
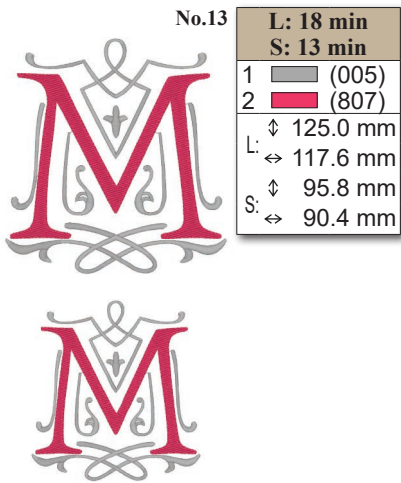
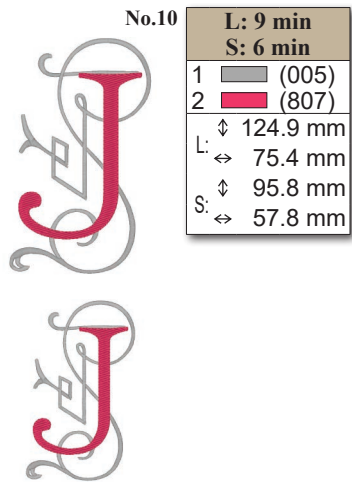













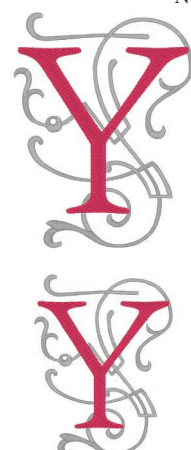































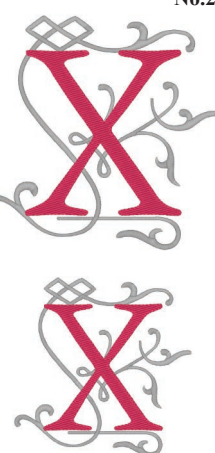

No.9

L: 7 min S: 5 min	
1	■ (005)
2	■ (807)
↓ 124.9 mm	
L:	↔ 66.0 mm
↓ 95.8 mm	
S:	↔ 50.6 mm





Embroidery Designs Color Change Table
Tabla de cambios de color para diseños de bordado
Tableau de changement de couleur des motifs de broderie

<p>No.19</p>  <table border="1"> <tr><td>L: 12 min</td></tr> <tr><td>S: 8 min</td></tr> <tr><td>1  (005)</td></tr> <tr><td>2  (807)</td></tr> <tr><td>↓ 125.0 mm</td></tr> <tr><td>L: ↔ 77.2 mm</td></tr> <tr><td>↓ 95.8 mm</td></tr> <tr><td>S: ↔ 59.1 mm</td></tr> </table>	L: 12 min	S: 8 min	1  (005)	2  (807)	↓ 125.0 mm	L: ↔ 77.2 mm	↓ 95.8 mm	S: ↔ 59.1 mm	<p>No.22</p>  <table border="1"> <tr><td>L: 13 min</td></tr> <tr><td>S: 9 min</td></tr> <tr><td>1  (005)</td></tr> <tr><td>2  (807)</td></tr> <tr><td>↓ 124.5 mm</td></tr> <tr><td>L: ↔ 103.8 mm</td></tr> <tr><td>↓ 95.8 mm</td></tr> <tr><td>S: ↔ 80.0 mm</td></tr> </table>	L: 13 min	S: 9 min	1  (005)	2  (807)	↓ 124.5 mm	L: ↔ 103.8 mm	↓ 95.8 mm	S: ↔ 80.0 mm	<p>No.25</p>  <table border="1"> <tr><td>L: 13 min</td></tr> <tr><td>S: 8 min</td></tr> <tr><td>1  (005)</td></tr> <tr><td>2  (807)</td></tr> <tr><td>↓ 124.8 mm</td></tr> <tr><td>L: ↔ 95.6 mm</td></tr> <tr><td>↓ 95.8 mm</td></tr> <tr><td>S: ↔ 73.4 mm</td></tr> </table>	L: 13 min	S: 8 min	1  (005)	2  (807)	↓ 124.8 mm	L: ↔ 95.6 mm	↓ 95.8 mm	S: ↔ 73.4 mm
L: 12 min																										
S: 8 min																										
1  (005)																										
2  (807)																										
↓ 125.0 mm																										
L: ↔ 77.2 mm																										
↓ 95.8 mm																										
S: ↔ 59.1 mm																										
L: 13 min																										
S: 9 min																										
1  (005)																										
2  (807)																										
↓ 124.5 mm																										
L: ↔ 103.8 mm																										
↓ 95.8 mm																										
S: ↔ 80.0 mm																										
L: 13 min																										
S: 8 min																										
1  (005)																										
2  (807)																										
↓ 124.8 mm																										
L: ↔ 95.6 mm																										
↓ 95.8 mm																										
S: ↔ 73.4 mm																										
<p>No.20</p>  <table border="1"> <tr><td>L: 10 min</td></tr> <tr><td>S: 7 min</td></tr> <tr><td>1  (005)</td></tr> <tr><td>2  (807)</td></tr> <tr><td>↓ 124.8 mm</td></tr> <tr><td>L: ↔ 82.8 mm</td></tr> <tr><td>↓ 95.8 mm</td></tr> <tr><td>S: ↔ 63.6 mm</td></tr> </table>	L: 10 min	S: 7 min	1  (005)	2  (807)	↓ 124.8 mm	L: ↔ 82.8 mm	↓ 95.8 mm	S: ↔ 63.6 mm	<p>No.23</p>  <table border="1"> <tr><td>L: 15 min</td></tr> <tr><td>S: 10 min</td></tr> <tr><td>1  (005)</td></tr> <tr><td>2  (807)</td></tr> <tr><td>↓ 124.8 mm</td></tr> <tr><td>L: ↔ 124.8 mm</td></tr> <tr><td>↓ 95.8 mm</td></tr> <tr><td>S: ↔ 96.0 mm</td></tr> </table>	L: 15 min	S: 10 min	1  (005)	2  (807)	↓ 124.8 mm	L: ↔ 124.8 mm	↓ 95.8 mm	S: ↔ 96.0 mm	<p>No.26</p>  <table border="1"> <tr><td>L: 13 min</td></tr> <tr><td>S: 9 min</td></tr> <tr><td>1  (005)</td></tr> <tr><td>2  (807)</td></tr> <tr><td>↓ 124.4 mm</td></tr> <tr><td>L: ↔ 106.3 mm</td></tr> <tr><td>↓ 95.8 mm</td></tr> <tr><td>S: ↔ 81.8 mm</td></tr> </table>	L: 13 min	S: 9 min	1  (005)	2  (807)	↓ 124.4 mm	L: ↔ 106.3 mm	↓ 95.8 mm	S: ↔ 81.8 mm
L: 10 min																										
S: 7 min																										
1  (005)																										
2  (807)																										
↓ 124.8 mm																										
L: ↔ 82.8 mm																										
↓ 95.8 mm																										
S: ↔ 63.6 mm																										
L: 15 min																										
S: 10 min																										
1  (005)																										
2  (807)																										
↓ 124.8 mm																										
L: ↔ 124.8 mm																										
↓ 95.8 mm																										
S: ↔ 96.0 mm																										
L: 13 min																										
S: 9 min																										
1  (005)																										
2  (807)																										
↓ 124.4 mm																										
L: ↔ 106.3 mm																										
↓ 95.8 mm																										
S: ↔ 81.8 mm																										
<p>No.21</p>  <table border="1"> <tr><td>L: 15 min</td></tr> <tr><td>S: 10 min</td></tr> <tr><td>1  (005)</td></tr> <tr><td>2  (807)</td></tr> <tr><td>↓ 124.8 mm</td></tr> <tr><td>L: ↔ 125.8 mm</td></tr> <tr><td>↓ 95.8 mm</td></tr> <tr><td>S: ↔ 96.6 mm</td></tr> </table>	L: 15 min	S: 10 min	1  (005)	2  (807)	↓ 124.8 mm	L: ↔ 125.8 mm	↓ 95.8 mm	S: ↔ 96.6 mm	<p>No.24</p>  <table border="1"> <tr><td>L: 15 min</td></tr> <tr><td>S: 10 min</td></tr> <tr><td>1  (005)</td></tr> <tr><td>2  (807)</td></tr> <tr><td>↓ 124.8 mm</td></tr> <tr><td>L: ↔ 123.8 mm</td></tr> <tr><td>↓ 95.8 mm</td></tr> <tr><td>S: ↔ 94.8 mm</td></tr> </table>	L: 15 min	S: 10 min	1  (005)	2  (807)	↓ 124.8 mm	L: ↔ 123.8 mm	↓ 95.8 mm	S: ↔ 94.8 mm									
L: 15 min																										
S: 10 min																										
1  (005)																										
2  (807)																										
↓ 124.8 mm																										
L: ↔ 125.8 mm																										
↓ 95.8 mm																										
S: ↔ 96.6 mm																										
L: 15 min																										
S: 10 min																										
1  (005)																										
2  (807)																										
↓ 124.8 mm																										
L: ↔ 123.8 mm																										
↓ 95.8 mm																										
S: ↔ 94.8 mm																										

Designs No.1 - No.26, are designed by Hang to Dry.
 Los diseños del N°1 al N° 26 están diseñados por Hang to Dry.
 Les motifs n° 1 à 26 sont conçus par Hang to Dry.

- Appliqué alphabet
- Diseños alfabéticos con adornos
- Alphabet d'appliqués

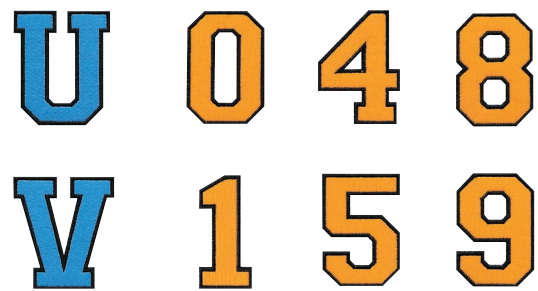

* Approximate size/Tamaño aproximado/Taille approximative

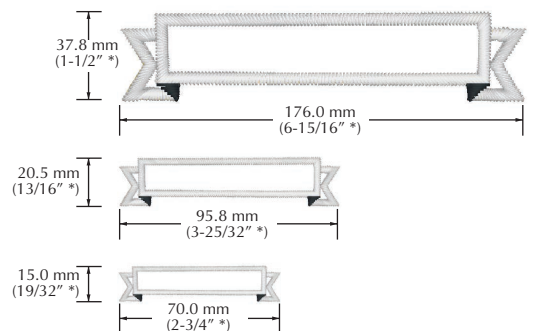
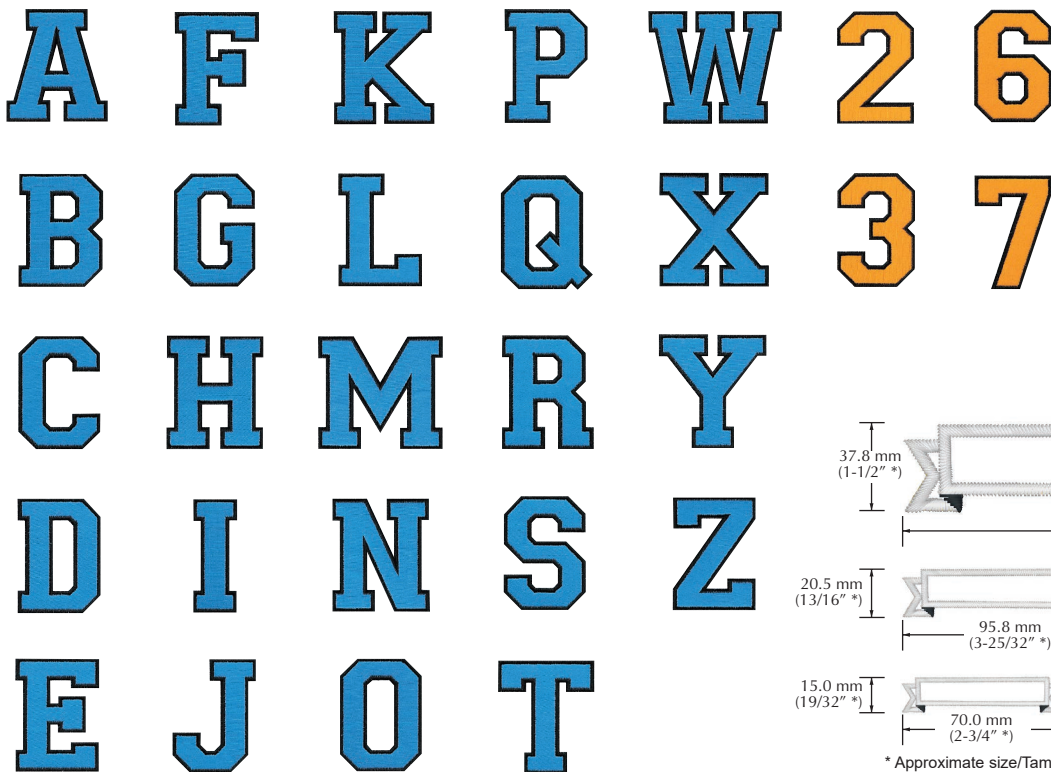

* Approximate size/Tamaño aproximado/Taille approximative

- ♥ Refer to the instruction and reference guide for the embroidery machine for details on how to embroider appliqués.
- ♥ Consulte el Guía de referencia y de instrucciones de la máquina de bordar si desea más información sobre cómo bordar appliques.
- ♥ Reportez-vous au Guide d'instructions et de référence de la machine à broder pour plus d'informations sur la broderie des appliqués.

Embroidery Designs Color Change Table
Tabla de cambios de color para diseños de bordado
Tableau de changement de couleur des motifs de broderie

- Appliqué Greek alphabet
- Alfabeto griego con adornos
- Alphabet grec d'appliqués



<p>No.1</p> <p>3 min</p> <p>1 (420) 2 (420) 3 (509) 4 (509)</p> <p>↓ 77.8 mm ⇔ 80.4 mm</p>	<p>No.7</p> <p>5 min</p> <p>1 (420) 2 (420) 3 (509) 4 (509)</p> <p>↓ 75.9 mm ⇔ 78.5 mm</p>	<p>No.13</p> <p>4 min</p> <p>1 (420) 2 (420) 3 (509) 4 (509)</p> <p>↓ 78.3 mm ⇔ 78.4 mm</p>	<p>No.19</p> <p>3 min</p> <p>1 (420) 2 (420) 3 (509) 4 (509)</p> <p>↓ 76.1 mm ⇔ 68.0 mm</p>
<p>No.2</p> <p>4 min</p> <p>1 (420) 2 (420) 3 (509) 4 (509)</p> <p>↓ 76.0 mm ⇔ 70.7 mm</p>	<p>No.8</p> <p>5 min</p> <p>1 (420) 2 (420) 3 (509) 4 (509)</p> <p>↓ 80.2 mm ⇔ 73.9 mm</p>	<p>No.14</p> <p>5 min</p> <p>1 (420) 2 (420) 3 (509) 4 (509)</p> <p>↓ 76.1 mm ⇔ 68.5 mm</p>	<p>No.20</p> <p>3 min</p> <p>1 (420) 2 (420) 3 (509) 4 (509)</p> <p>↓ 75.9 mm ⇔ 79.1 mm</p>
<p>No.3</p> <p>3 min</p> <p>1 (420) 2 (420) 3 (509) 4 (509)</p> <p>↓ 76.0 mm ⇔ 68.2 mm</p>	<p>No.9</p> <p>2 min</p> <p>1 (420) 2 (420) 3 (509) 4 (509)</p> <p>↓ 76.0 mm ⇔ 38.1 mm</p>	<p>No.15</p> <p>3 min</p> <p>1 (420) 2 (420) 3 (509) 4 (509)</p> <p>↓ 80.3 mm ⇔ 73.9 mm</p>	<p>No.21</p> <p>5 min</p> <p>1 (420) 2 (420) 3 (509) 4 (509)</p> <p>↓ 75.9 mm ⇔ 78.0 mm</p>
<p>No.4</p> <p>3 min</p> <p>1 (420) 2 (420) 3 (509) 4 (509)</p> <p>↓ 77.7 mm ⇔ 70.0 mm</p>	<p>No.10</p> <p>4 min</p> <p>1 (420) 2 (420) 3 (509) 4 (509)</p> <p>↓ 76.1 mm ⇔ 80.5 mm</p>	<p>No.16</p> <p>4 min</p> <p>1 (420) 2 (420) 3 (509) 4 (509)</p> <p>↓ 75.9 mm ⇔ 82.6 mm</p>	<p>No.22</p> <p>4 min</p> <p>1 (420) 2 (420) 3 (509) 4 (509)</p> <p>↓ 76.0 mm ⇔ 80.8 mm</p>
<p>No.5</p> <p>4 min</p> <p>1 (420) 2 (420) 3 (509) 4 (509)</p> <p>↓ 76.1 mm ⇔ 69.8 mm</p>	<p>No.11</p> <p>3 min</p> <p>1 (420) 2 (420) 3 (509) 4 (509)</p> <p>↓ 78.0 mm ⇔ 76.0 mm</p>	<p>No.17</p> <p>3 min</p> <p>1 (420) 2 (420) 3 (509) 4 (509)</p> <p>↓ 76.0 mm ⇔ 62.0 mm</p>	<p>No.23</p> <p>4 min</p> <p>1 (420) 2 (420) 3 (509) 4 (509)</p> <p>↓ 76.0 mm ⇔ 86.7 mm</p>
<p>No.6</p> <p>3 min</p> <p>1 (420) 2 (420) 3 (509) 4 (509)</p> <p>↓ 76.0 mm ⇔ 67.4 mm</p>	<p>No.12</p> <p>5 min</p> <p>1 (420) 2 (420) 3 (509) 4 (509)</p> <p>↓ 76.0 mm ⇔ 95.3 mm</p>	<p>No.18</p> <p>4 min</p> <p>1 (420) 2 (420) 3 (509) 4 (509)</p> <p>↓ 76.0 mm ⇔ 69.0 mm</p>	<p>No.24</p> <p>5 min</p> <p>1 (420) 2 (420) 3 (509) 4 (509)</p> <p>↓ 78.0 mm ⇔ 74.1 mm</p>

- ♥ Refer to the instruction and reference guide for the embroidery machine for details on how to embroider appliqués.
- ♥ Consulte el Guía de referencia y de instrucciones de la máquina de bordar si desea más información sobre cómo bordar appliques.
- ♥ Reportez-vous au Guide d'instructions et de référence de la machine à broder pour plus d'informations sur la broderie des appliqués.

- ❖ Monograms
- ❖ Monogramas
- ❖ Monogrammes

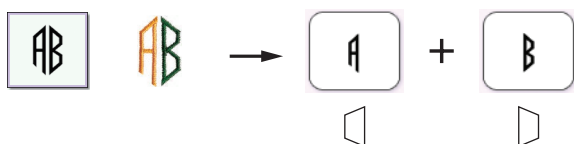
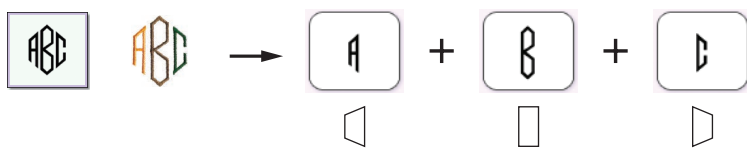

- Monogram Frames
- Costuras de encuadre con texto de monograma
- Encadrements pour monogrammes

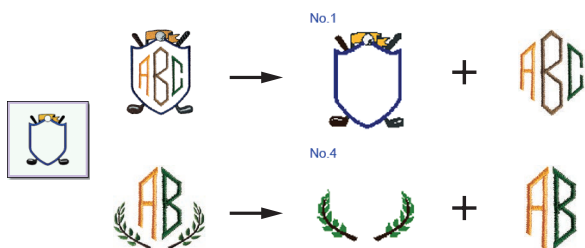

Embroidery Designs Color Change Table
Tabla de cambios de color para diseños de bordado
Tableau de changement de couleur des motifs de broderie

❖ **Monogram Frames**

❖ **Costuras de encuadre con texto de monograma**

❖ **Encadrements pour monogrammes**



No.1

L: 5 min
M: 3 min
S: 2 min
1 (001)
2 (058)
3 (208)
4 (707)
5 (007)
↓ 94.4 mm
L: ↔ 73.6 mm
↓ 64.1 mm
M: ↔ 50.1 mm
↓ 40.9 mm
S: ↔ 31.2 mm

No.4

L: 2 min
M: 1 min
S: 1 min
1 (515)
2 (058)
↓ 48.4 mm
L: ↔ 92.5 mm
↓ 31.2 mm
M: ↔ 59.5 mm
↓ 19.1 mm
S: ↔ 36.4 mm

No.7

L: 2 min
M: 1 min
S: 1 min
1 (214)
2 (843)
↓ 84.8 mm
L: ↔ 84.8 mm
↓ 55.0 mm
M: ↔ 54.9 mm
↓ 33.9 mm
S: ↔ 33.9 mm

No.2

L: 5 min
M: 3 min
S: 2 min
1 (001)
2 (513)
3 (208)
4 (007)
5 (900)
↓ 90.1 mm
L: ↔ 81.6 mm
↓ 60.2 mm
M: ↔ 54.9 mm
↓ 38.8 mm
S: ↔ 36.1 mm

No.5

L: 1 min
M: 1 min
S: 1 min
1 (205)
2 (085)
3 (612)
4 (800)
↓ 92.5 mm
L: ↔ 78.9 mm
↓ 59.6 mm
M: ↔ 50.9 mm
↓ 34.9 mm
S: ↔ 29.7 mm

No.8

L: 2 min
M: 1 min
S: 1 min
1 (507)
2 (800)
↓ 94.9 mm
L: ↔ 94.4 mm
↓ 63.6 mm
M: ↔ 63.9 mm
↓ 39.9 mm
S: ↔ 40.2 mm

No.3

L: 3 min
M: 2 min
S: 1 min
1 (323)
↓ 93.8 mm
L: ↔ 64.5 mm
↓ 61.4 mm
M: ↔ 42.6 mm
↓ 40.3 mm
S: ↔ 27.5 mm

No.6

L: 3 min
M: 1 min
S: 1 min
1 (328)
↓ 77.5 mm
L: ↔ 78.2 mm
↓ 50.0 mm
M: ↔ 50.4 mm
↓ 29.7 mm
S: ↔ 29.9 mm

No.9

L: 3 min
M: 1 min
S: 1 min
1 (900)
2 (515)
3 (214)
↓ 94.6 mm
L: ↔ 72.3 mm
↓ 59.5 mm
M: ↔ 46.0 mm
↓ 37.2 mm
S: ↔ 28.8 mm

Embroidery Designs Color Change Table
Tabla de cambios de color para diseños de bordado
Tableau de changement de couleur des motifs de broderie

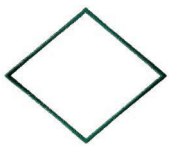

No.10



L: 2 min M: 1 min S: 1 min	
1	 (534)
	↓ 83.4 mm
L:	↔ 98.7 mm
	↓ 56.1 mm
M:	↔ 66.8 mm
	↓ 35.1 mm
S:	↔ 41.8 mm

No.12



L: 1 min M: 1 min S: 1 min	
1	 (070)
2	 (612)
	↓ 22.7 mm
L:	↔ 90.0 mm
	↓ 14.5 mm
M:	↔ 57.4 mm
	↓ 8.9 mm
S:	↔ 34.6 mm

No.14



L: 1 min M: 1 min S: 1 min	
1	 (800)
	↓ 24.4 mm
L:	↔ 88.1 mm
	↓ 15.1 mm
M:	↔ 56.7 mm
	↓ 8.4 mm
S:	↔ 38.9 mm

No.11



L: 1 min M: 1 min S: 1 min	
1	 (620)
	↓ 25.2 mm
L:	↔ 89.4 mm
	↓ 16.8 mm
M:	↔ 57.4 mm
	↓ 9.1 mm
S:	↔ 34.0 mm



No.13



L: 1 min M: 1 min S: 1 min	
1	 (208)
	↓ 28.3 mm
L:	↔ 91.4 mm
	↓ 18.4 mm
M:	↔ 59.0 mm
	↓ 11.4 mm
S:	↔ 36.1 mm

No.15



L: 2 min M: 1 min S: 1 min	
1	 (214)
2	 (058)
	↓ 24.3 mm
L:	↔ 54.4 mm
	↓ 15.5 mm
M:	↔ 34.7 mm
	↓ 9.3 mm
S:	↔ 20.8 mm

Examples of Combinations

Ejemplos de combinaciones

Exemples de combinaisons

- Embroidery patterns on these pages are illustration images, which may be different from the patterns in your machine.
- Los diseños de bordado de estas páginas son ilustraciones, que pueden ser diferentes de los diseños de la máquina.
- Les motifs de broderie figurant sur ces pages sont des images d'illustration qui peuvent différer des motifs proposés par votre machine.



No.2 =  (900)



No.6 × 2 + No.8



No.16 × 2 + No.17 × 2



No.2 + No.27 × 2



No.6 + No.10 + No.19

Create 3D embroidery Crear bordados en 3D Créer une broderie 3D

You can make 3D embroidery by using urethane foam for embroidery.
Refer to the Instruction and Reference guide for the embroidery machine for details on how to embroider 3D font.

Puede realizar bordados en 3D utilizando espuma de uretano para bordar.
Consulte la Guía de referencia y de instrucciones de la máquina de bordar si desea más información sobre cómo bordar el tipo de letra 3D.

Vous pouvez créer une broderie 3D en utilisant de la mousse puffy pour la broderie.
Reportez-vous au guide d'instructions et de référence de la machine à broder pour plus d'informations sur la broderie des polices 3D.

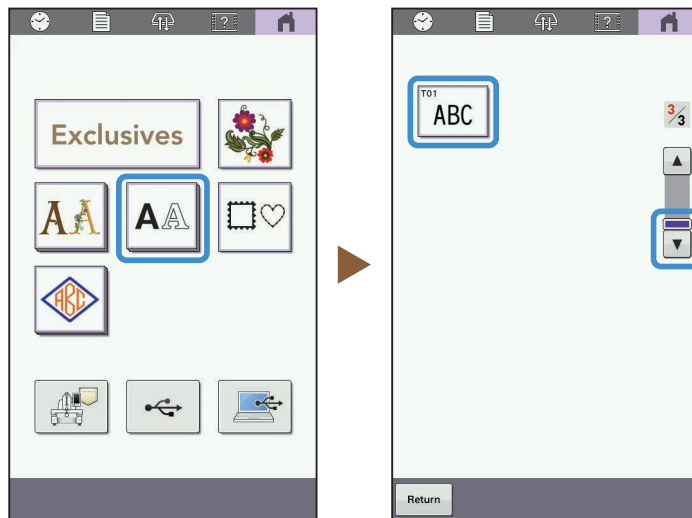

Instruction Video
Vídeo de instrucciones
Vidéo d'instructions



<https://babylock.com/capella-puffyfoam>

* We recommend that flat brim cap frame (sold separately) be used for embroidering caps. Refer to "Optional accessories" in the Instruction and Reference guide.

* Recomendamos utilizar el bastidor para gorras (no incluido) para bordar gorras. Consulte la sección "Accesorios opcionales" en la Guía de referencia y de instrucciones.

* Nous recommandons d'utiliser le cadre à broder pour casquette à bord plat (vendu séparément) pour broder des casquettes. Reportez-vous à la section « Accessoires en option » du guide d'instructions et de référence.

Color Thread Conversion Chart

Tabla de conversión de hilos de color

Tableau de conversion des fils de couleur

*

No.	Color Name	R.A. Polyester	R.A. Rayon	Isacord Polyester	Madeira Polyneon	Madeira Rayon	Sulky Polyester	Sulky Rayon	Gütermann Dekor	Country	Embr.	
1	Pink	5523	2223	*0180	1921	1121	1224	1108	*4830	155	085	
2	Dusty Rose	5675		2155	1816	1108						
3	Petal Pink	7701	2255			1015						
4	Light Pink	9030		1860								
5	Light Coral	9078			1915			1148				
6	Ginger Jar	9080		2170		1115						
7	Heather Mist	9070		1755								
8	Champagne	9063		2051								
9	Dark Mauve	9015		2153				1119				
10	Heather	9164		2152								
11	Neon Pink	5711			1948							
12	Comfort Pink	9077				1119			5435			
13	Mountain Rose	5795	2373			1315						
14	Cherry Pink	5544	2244									
15	Carnation	5537	2509					1188				
16	Salmon	9073	2553	1840		1018						
17	Shrimp	5546						1154				
18	Dark Coral	9065	2246									
19	Bitterroot	7709	2277									
20	Burgundy	5549	2249	2022		1182		1169				
21	Warm Wine	5796	2622		1782			1309				
22	Russet	5552		2123	1781							
23	Plum	9055	2498			1389						
24	Maroon	5676		2115	1919							
25	Royal Crest	9162							5400			
26	Hot Pink	5560							5385			
27	Ruby	5797				1183						
28	Dark Fuchsia	5804	2504	*2300	1984	1383	1533	1533	*4810	126	107	
29	Carmine	5561	*2419	2300	1986	*1081	1511	*1511	5315	158	807	
30	Dark Pink	9161			1994				4810			
31	Deep Rose	9168	*2508	2520	1721	*1117	1154	1307	*4941	024	086	
32	Begonia	5528				1117						
33	Azalea	7712		2220								
34	Rubine Red	9012				1186			4740			
35	Strawberry	5732		2320	1910							
36	Devil Red	7706	2507	1906	1986							
37	Candy Apple Red	5807		1805		1081						
38	Hollyhock Red	9006	2267	1912				1311				
39	Toasty Red	9002	2418	1902		1181						
40	Wild Fire	5567							4700			
41	Red	5678	2505	2101	1637	*1037	1037	*1037	*4740	149	800	
42	Jockey Red	5581			1747							
43	Radiant Red	5566	2219					561	4731			
44	Red Berry	5718			1839							
45	Foxy Red	5563			1838	1147		1147				
46	Lipstick	5533	2263	1900								
47	Christmas red	9170	2420	1800		1037		1317				
48	Scarlet	5519	2281	1904								
49	Deep Scarlet	5811		1913								
50	Cranberry	5570	2270	1911					4160			
51	Dark Cherry	5908			1974							
52	Flesh Pink	5677	*2347	*2170	1915	*1015	1064	*1064	*5136	152	124	
53	Bisque	5553		1551		1019						
54	Flamingo	5558	2414	1532					4865			
55	Melon	5594	2512									
56	Peach Melba	9058		1600								
57	Watermelon	5712							4595			
58	Honeysuckle	7713		1521								
59	Dark Orange	9056		1335	1621	1021		1021				
60	Clear Blue	9029										
61	Blue Joy	9032	2598	0145								
62	Ice Blue	5600	2300			1074		1074				
63	Medium Blue	9089						1248				
64	Rockport Blue	5836			1960	1360						
65	Pastel Blue	5682	2239	3951	1953							
66	Baby Blue	5539					1202					
67	Sky Blue	5506	*2239	*3641	1828	*1028	1196	*1196	*6575	512	019	
68	Light Blue	5683	*2222	*3640	1932	*1276	1074	*1074	*6280	150	017	
69	Lake Blue	5604	2206		1874	1075		1028				
70	Happy Blue	9039		3820	1675	1028		1029				
71	Ultra Blue	5733						1134				
72	Tropic Blue	5734	2530					1196				
73	Cornflower Blue	5601	2526	3641	1830	*1335	1028	1076	*5900	015	070	

* Closest color match * Concordancia con el color más cercano * L'assortiment de couleurs le plus proche

*

No.	Color Name	R.A. Polyester	R.A. Rayon	Isacord Polyester	Madeira Polyneon	Madeira Rayon	Sulky Polyester	Sulky Rayon	Gütermann Dekor	Country	Embr.	
74	Blue Moon	9081				1375						
75	Sapphire	5545	2529			1029		1253	6010			
76	Slate Blue	5575		3953								
77	Dark Blue	5641	2341		1964							
78	Deep Blue	9075	2612	3444	1775	1364						
79	Wonder Blue	5877	2577			1160		1172				
80	Baltic Blue	5820		4032								
81	California Blue	5689	2520	3901								
82	Cerulean	5801	2441			1176		1534				
83	Solar Blue	5741	2442		1797							
84	Electric Blue	5829	*2528	3815	*1893	*1297	1250	*1250	*6746	564	420	
85	Pacific Blue	5520		3600								
86	Blue	5684	*2220	*3543	1829	*1177	1076	*1076	*6010	586	405	
87	Imperial Blue	5602	2302	3622		1042		1143				
88	Fleet Blue	5750			1966							
89	Blue Ribbon	5739	2613		1742			1044				
90	Light Navy	5603	2603		1643	1044		505				
91	Medium Navy	5824	2303	3323				1043				
92	Empire Blue	5686		3355	1967							
93	Blue Ink	5909				1243						
94	Midnight Navy	5687		3344								
95	Dark Sapphire	5580	2436		1842				6655			
96	Blue Suede	5738	2220	3544	1642			1535				
97	Ultra Marine	5736	2429	3612	1676	1166	1042	572	*6746	575	406	
98	Royal Blue	5510	2280			1076						
99	Cobalt Blue	5685		3543				526				
100	Prussian Blue	5737	*2627	*3344	*1961	*1076	1535	*1535	*6655	588	007	
101	Nassau Blue	9022	2625					1293				
102	Chow Blue	9171		3102	1767							
103	Paris Blue	5583	2304	3640		1030						
104	Blue Lavender	9048	2384	3331	1830	1143						
105	Medium Lavender	5706	2406	3251								
106	Lavender	5586	*2276	*3045	1911	*1261	1193	*1193	*5865	604	804	
107	Tulip Lavender	9167			1630							
108	Wisteria Violet	5587	2287	*2830	*1631	*1311	1032	1296	*6010	003	607	
109	Queen Purple	9031						1112				
110	Livid Lavender	9166			1943	1330						
111	Purple Chariot	9049						1242				
112	Purple Maze	5728	2742	3110								
113	Deep Purple	5803						1235	5885			
114	Purple Accent	5731			1922	1112						
115	King Purple	9053	2431			1312						
116	Royal Purple	5681	*2381	*2711	1788	*1188	1192	*1192	*6660	636	869	
117	Mod Purple	9071		2715		1033		1255				
118	Purple	5554	2430	*2905	1880	1122	1122	1122	5727	635	614	
119	Violet	5588	*2285	*3541	1631	*1033	1194	*1194	*5729	624	613	
120	Pale Purple	9088		2910		1032		1194				
121	Magenta	5592	2426	*2764	1710	*1235	1191	*1191	*5885	625	620	
122	Light Lilac	9016	*2588	*2650	1911	*1031	1121	*1121	*	133	810	
123	Lilac	9009	*2424	*2830	1831	*1080	1080	1080	*5827	623	612	
124	Siberian iris	9041						1031				
125	Fantasia Pink	9044				1120			4830			
126	Dream Pink	9040		2250					5185			
127	Exclusive Pink	9074		2160		1014						
128	Pink Splendor	9037						1224				
129	Wild Pink	5559			1921	1309		1515				
130	Amber Red	5591	2590	*1725	1942	1310	1119	*1119	*5300	212	333	
131	Raspberry Ice	9017		2506	1710	1188						
132	Aubergine	9046		2600	1172							
133	Bambino Blue	9079		3910	1827							
134	Blue Fringe	9054		4113	1694			1090				
135	Marine Aqua	5607		4010				1206				
136	Blue Wisteria	9052		4101	1895							
137	Angel Blue	9060				1295						
138	Mallard Blue	5821	2446		1890							
139	Peacock Blue	5810	*2515	4116	*1685	*1052	1206	*1206	*7030	057	415	
140	Dark Jade	9143		4643	1652	1252						
141	Paradise Green	9104	2549	4515		1290						
142	Perpetual Teal	9062			1762							
143	Venus Blue	9100		4033		1162						
144	Feather Blue	5522	2222	4250		1292			8700			
145	Mint Julep	5610						1045				

* Closest color match * Concordancia con el color más cercano * L'assortiment de couleurs le plus proche











*

No.	Color Name	R.A. Polyester	R.A. Rayon	Isacord Polyester	Madeira Polyneon	Madeira Rayon	Sulky Polyester	Sulky Rayon	Gütermann Dekor	Country	Embr.	
218	Day Lilly	9010		0824	1725			1025				
219	Star Gold	5708		0713		1172						
220	Golden Sunshine	5765		0811		1137		0567				
221	Brass	9109	2395	*0221	1791	*1192	1159	0502	*1625	404	328	
222	Orange	5694	2247	*1102	1951	*1137	1024	*1024	*1770	335	208	
223	Deep Gold	5512	2602	0904	*1772	*1172	1025	*1025	*1730	354	214	
224	Harvest Gold	5770	*2626	*0232	1971	*1024	1124	*1124	*1695	334	206	
225	Yellow Mist	5709	2394			1065		1238	1625			
226	Mustard	9050			1771							
227	Copper	5595		0922					1956			
228	Light Cantalope	5710			1946							
229	Grilled Orange	9072	2236			1078						
230	Orangeade	5767	2513	1301	1779							
231	Paprika	5536			1878	1146			3570			
232	Soft Pink	9159			1837							
233	Vermillion	9023	*2219	1701	1779	1307	1184	*1184	*4160	148	030	
234	Saffron	5629	2329	1703				1037				
235	Auburn	5772	2623					1263				
236	Terra Cotta	5634		1514		1039						
237	Dark Rust	5505	2205	1312		1179		1181				
238	Peach Mist	9157			1937							
239	Dark Melon	9068		1352		1152			5040			
240	Tawny	5556	2256		1882			1543	1790			
241	Soft Peach	9047		1362		1226						
242	Rust	5589		1332				0621				
243	Dark Apricot	9038	2330	1220								
244	Tangerine	5518		1114	1965		1078			336	209	
245	Pumpkin	5630			1952		1065			322	126	
246	Sunburst	5769	2469		1678			1078				
247	Gold Spice	5698						0562				
248	Honey	5547			1870	1155						
249	Almond	5779				1173						
250	Reddish Brown	5781			1753		1021	0568		264	337	
251	Clay Brown	5590	2290	0932	1621		1158	1158		224	339	
252	Russet Brown	5702			1726		1126			414	330	
253	Cream Brown	5761	2732		1866	1061	1061	1070	1195	331	010	
254	Creamy Yellow	5564			1861	1026	1135	1055		370	812	
255	Glow	5534	2234	0640		1270						
256	Pistachio	5550			1738							
257	Golden Tan	5870			1884				2610			
258	Ginger	5633						1159				
259	Temple Gold	9165			1772							
260	Tan	9130	2231	0842		1253		1126				
261	Suntan	9132		1141	1927							
262	Candy Tan	9094		0651		1055						
263	Beige	5598			1738		1127			012	843	
264	Rattan	5774	2493	1123		1126						
265	Dark Beige	5524		0934	1855	1056						
266	Antique Gold	5906		0822		1192						
267	Bronze	5815	2478			1144		1170				
268	Coffee	5777				1329						
269	Linen	5635					1082			025	307	
270	Seashell	5776	2298	1172	1682	1128						
271	Ecru	5532	2232			1149		1017				
272	Salmon Pink	5773			1816		1225			122	079	
273	Light Cocoa	5778		1154	1657				2670			
274	Dusty Peach	5638			1853			0619				
275	Light Brown	5789		0832	1729		1128			255	323	
276	Khaki	5636			1939		1055			242	348	
277	Coffee Bean	9156		1055	1945	1058		1057				
278	Brownstone	9042		1342	1758	1378						
279	Deep Brown	5551	2251		1658	1145		1186	2335			
280	Dark Brown	5637	2566		1859		1129			717	058	
281	Brown	5672						1129				
282	Happy Trail	9087	2488	1565		1057						
283	Dark Taupe	9128		0722		1054						
284	Warm Gray	9126		0861	1860		1218			706	399	
285	Deep Gray	9158	2541	1874		1131						
286	Metal	9111	2407	0111		1041		1041				
287	Black Chrome	5841	2411	1375	1795							
288	Charcoal	5865	2729		1640	1239		1220				
289	Medium Gray	5517	2585	0131		1118						

* Closest color match * Concordancia con el color más cercano * L'assortiment de couleurs le plus proche

Color Thread Conversion Chart
Tabla de conversión de hilos de color
Tableau de conversion des fils de couleur

*

No.	Color Name	R.A. Polyester	R.A. Rayon	Isacord Polyester	Madeira Polyneon	Madeira Rayon	Sulky Polyester	Sulky Rayon	Gütermann Dekor	Country	Embr.	
290	Cool Gray	9112		2674				1328				
291	Smoke Gray	9163		2576	1854			1179				
292	Pewter	9114			1840		1041			745	704	
293	Dark Gray	5565			1841		1220			747	707	
294	Gray	5782	2741	1972	1640		1219	1011		734	817	
295	Light Gray	5785	2733	0150				1327				
296	Chrome	5839						1325				
297	Silver	5640			1812	1087	1011			020	005	
298	Black	5596	2296	0020	1800	1000	1005	1005	9435	100	900	
299	Natural White	5642	2342			1003		1071				
300	White	5597	2403	0010	1801		1001	1002		000	001	

* Closest color match * Concordancia con el color más cercano * L'assortiment de couleurs le plus proche

Note: The conversion chart is based on Embroidery thread. The color shades may vary with the different brands listed on the chart. If unsure of a particular color(s), please sew test. Robison Anton (R.A.), Isacord, Madeira, Sulky and Gütermann are respectively registered trademarks. Actual colors may vary slightly from the chart.

Nota: La tabla de conversión está basada en hilo de bordar. Los tonos de color podrán variar con las diferentes marcas listadas en la tabla. Si tiene dudas sobre un color(es) particular, haga un cosido de prueba. "Robison Anton (R.A.)", "Isacord", "Madeira", "Sulky" y "Gütermann" son marcas registradas respectivamente. Los colores verdaderos podrán variar ligeramente con respecto a los de la tabla.

Remarque: Le tableau de conversion est basé sur un fil de broderie. Les nuances de couleur peuvent varier en fonction des marques énumérées dans le tableau. En cas de doute sur un coloris, faites un essai de couture. « Robison Anton (R.A.) », « Isacord », « Madeira », « Sulky » et « Gütermann » sont des marques déposées respectives. Les couleurs réelles risquent d'être légèrement différentes de celles du tableau.

Font Name Chart

Diagrama de nombre de las fuentes

Tableau des noms de polices

1		Exclusive Script
2		Block 01
3		Serif 01
4		Brussels Demi Outline
5		Tennessee ExtraBold
6		Brussels Light
7		Serif 02
8		Calgary MediumItalic
9		Maryland
10		Vermont
11		Dalliance Script
12		Sicilia Light Italic (Sicilia)
13		Luedickital
14		Toms Handwritten
15		Bergen
16		Tirol
17		Istanbul
18		San Diego

19		Los Angeles
20		Saipan
21		Gothic 01
22		Bayern Book
23		Florida Medium
24		Lillehammer
25		Dalliance Roman
26		Helsinki Nallow S*
27		Riesa S*
28		Germany S*
29		Script 01 SR*
30		Block 01*
31		Utah Bold Cyrillic
32		PC Tennessee Bold Cyrillic
33		Letter Gothic Bold

*Small font
 *Tipo de letra pequeña
 *Petite police

English
Spanish
French

882-T52



D02RSM-001