

b77



Quick Reference

bernette

SWISS DESIGN

# IMPORTANT SAFETY INSTRUCTIONS

Observe the following basic safety instructions when using your machine. Before using this machine, read instruction manual carefully.

## DANGER!

To reduce the risk of electrical shock:

- Never leave the machine unattended as long as it is plugged in.
- Always unplug the machine from the electrical outlet immediately after using.

Protection against LED radiation:

- Do not view the LED light directly with optical instruments (e.g. magnifier). The LED light corresponds with protection class 1M.
- When the LED light is damaged or defective, contact your bernette specialist dealer.

## WARNING

To reduce the risk of burns, fire, electric shock or injury to persons:

- To operate the machine always use the supplied power cable. USA and Canada only: Do not connect power plug NEMA 1-15 to circuits exceeding 150 volt-to-ground.
- Use this machine only for purposes as described in this manual.
- Only use the machine in dry rooms.
- Do not use the machine in a damp condition or in a damp environment.
- Do not use this machine as a toy. Close attention is necessary when this machine is used by or near children.
- The machine can be used by children older than 8 or by people with reduced physical, sensory or mental capabilities or if there is a lack of experience and knowledge how to operate the machine as long as they are supervised or have been given instruction concerning the responsible use of the appliance and are aware of the involved risks.
- Children are not allowed to play with this machine.
- Cleaning and maintenance work must not be carried out by children unless they are supervised.
- Never operate this machine if it has a damaged cord or plug, if it is not working properly, if it has been dropped or damaged, or dropped into water. Contact the nearest authorized bernette dealer to arrange further details.
- Only use accessory recommended by the manufacturer.
- Don't use this machine when the ventilation openings are blocked. Keep the ventilation openings and the foot control free from the accumulation of lint, dust and loose cloth.
- Never insert any objects into any openings of the machine.
- Do not place any objects on the foot control.
- Always use the machine with a foot control of this type FC-210.
- Do not operate the machine where aerosol products (sprays) or oxygen are being used.
- Keep fingers away from all moving parts. Special care is required around the needle.
- Neither pull nor push the fabric while sewing. This can cause needle breakage.
- When making any adjustments in the needle area – such as such as threading the needle, changing the needle, threading the hook or changing the presser foot – turn power switch to «0».
- Do not use bent needles.
- Always use the original bernette stitch plate. The wrong stitch plate can cause needle breakage.

- To disconnect, turn power switch to «0» and then remove the plug from the outlet. Do not unplug by pulling the cord, instead grasp the plug to pull it from the outlet.
- Always disconnect the power plug from the electrical outlet when the covers are removed or opened, when the machine is lubricated or during any other maintenance adjustments mentioned in the instruction manual.
- This machine is provided with double insulation (except USA, Canada and Japan). Use only identical replacement parts. See instructions for Servicing of double-insulated products.
- The sound pressure level is lower than 70 dB(A) under normal conditions.

## Important information

### Availability of the instruction manual

The instruction manual is supplied with the machine.

Keep the instruction manual safe at a suitable place near the machine to have it at hand in case that you need to look up something.

If you pass the machine to a third party, always include the instruction manual.

### Proper use

Your bernette machine is conceived and designed for private household use. It answers the purpose to quilt fabrics as it is described in this instruction manual. Any other use is not considered appropriate. bernette assumes no liability concerning consequences resulting from an inappropriate usage.

### Maintenance of double-insulated products

In a double-insulated product two systems of insulation are provided instead of grounding. No grounding means is provided on a doubleinsulated product, nor should a means for grounding be added to the product. Servicing a double-insulated product requires extreme care and knowledge of the system and should be done only by qualified service personnel. Replacement parts for a double-insulated product must be identical to the original parts in the product. A double-insulated product is marked with the words: "double insulation" or "double-insulated".



The symbol may also be marked on the product.

### Protection of the environment



BERNINA is committed to the protection of the environment. We strive to minimize the environmental impact of our products by continuously improving product design and our technology of manufacturing.

The machine is labeled with the symbol of the crossed-out wastebasket. This means that the machine must not be disposed of with the household waste when the machine is no longer needed. Improper disposal can result in dangerous substances getting into the groundwater and thus into our food chain, damaging our health.

The machine must be returned free of charge to a nearby collection point for waste electrical and electronic equipment or to a collection point for the reuse of the machine. Information on the collection points can be obtained from your local administration. When purchasing a new machine, the dealer is obliged to take back the old machine free of charge and dispose of it properly.

If the machine contains personal data, you are responsible for deleting the data yourself before returning the machine.

# Content

Connection and switching on .....	1
Winding the bobbin thread.....	1
Threading the bobbin thread .....	2
Threading the upper thread .....	2
Overview selection menu .....	4
Changing the presser foot .....	4

## Connection and switching on

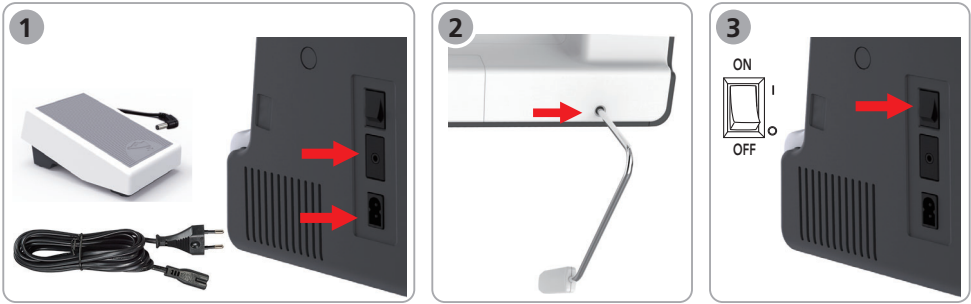

## Winding the bobbin thread

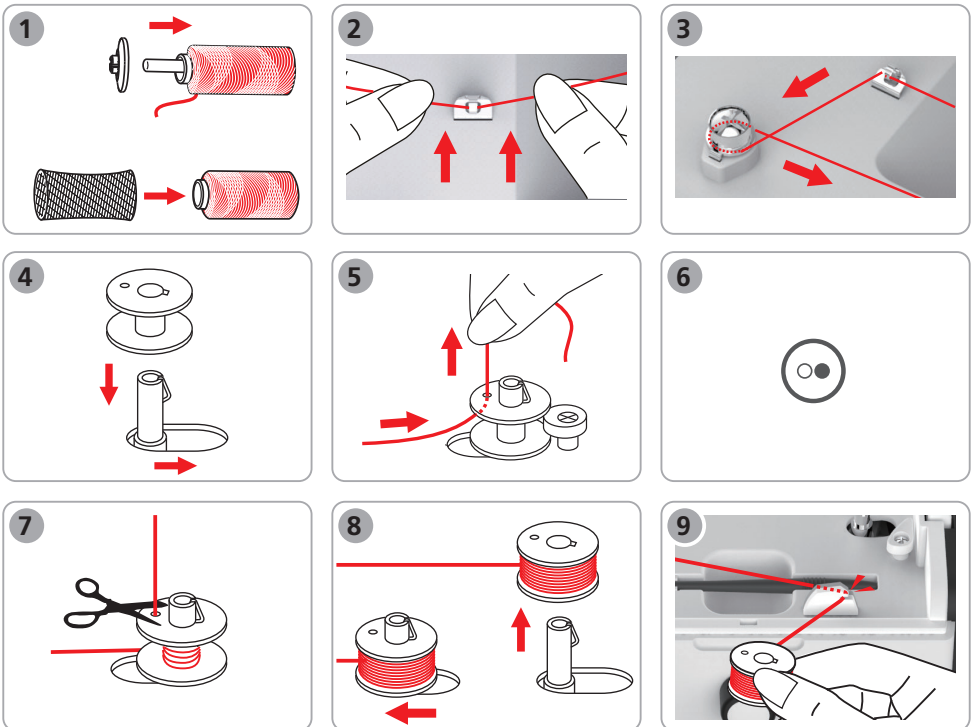
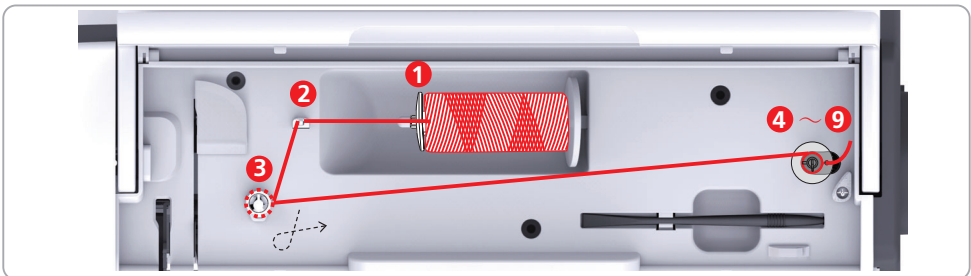

## Threading the bobbin thread

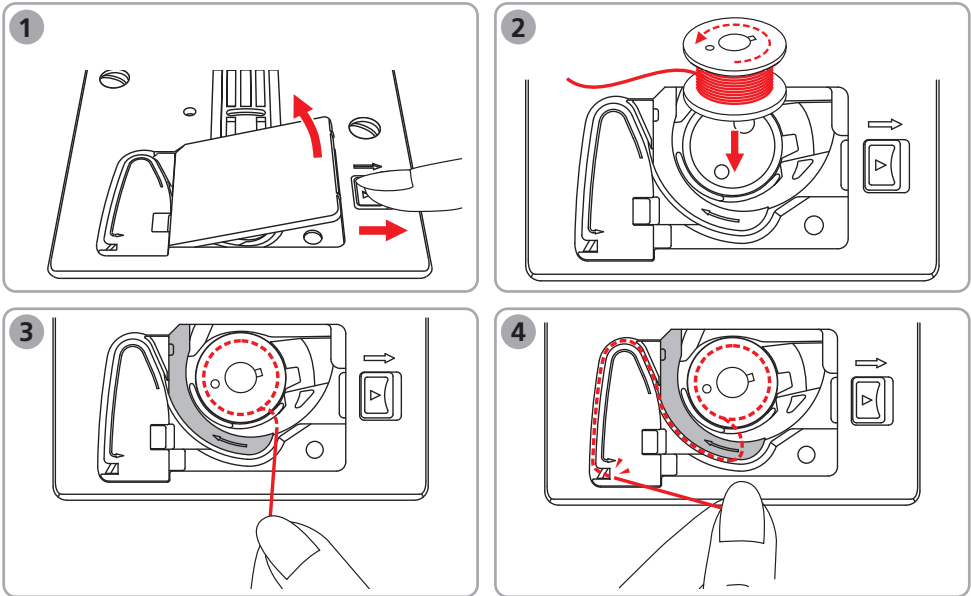

## Threading the upper thread

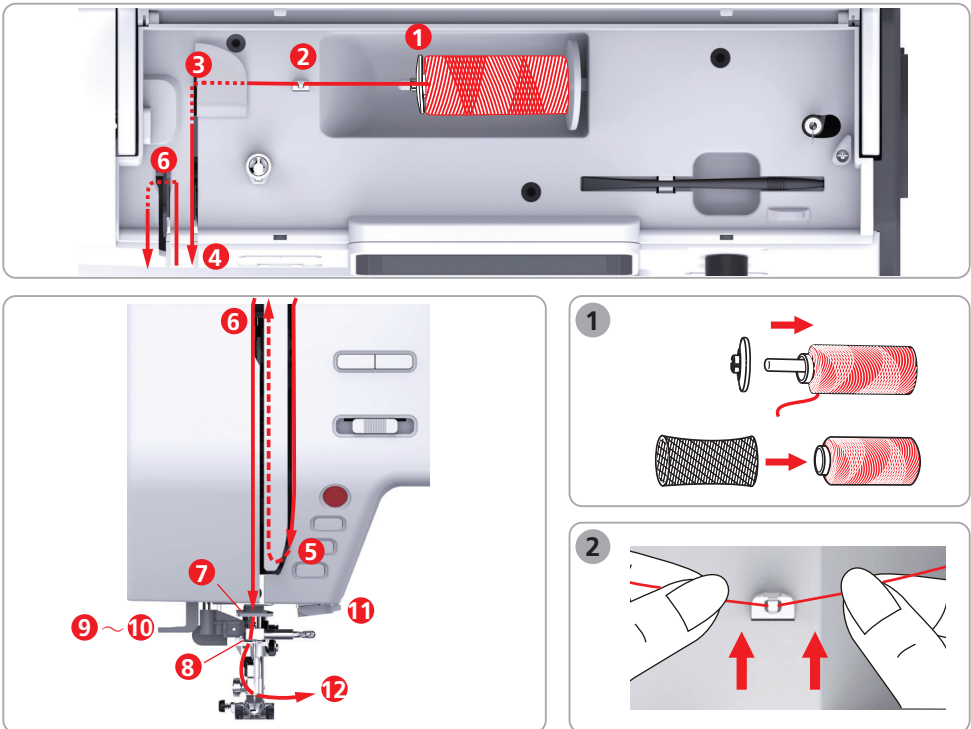

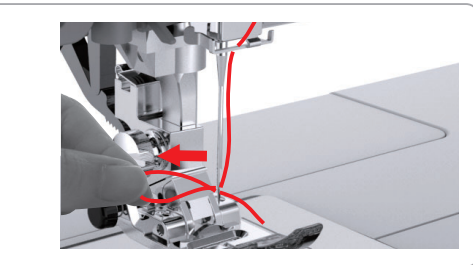
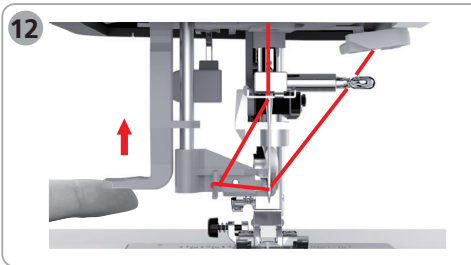
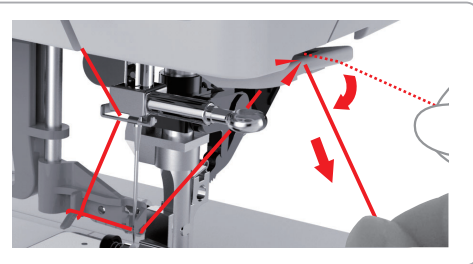
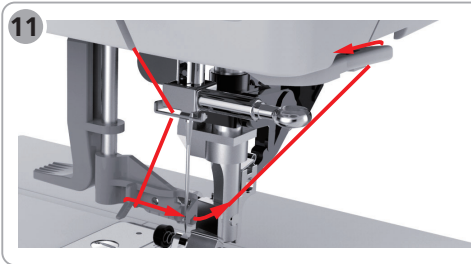
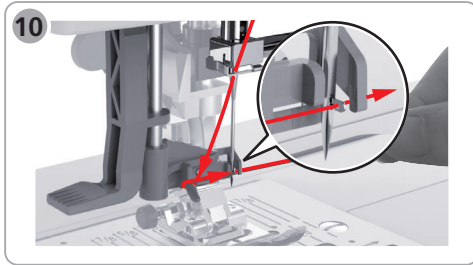
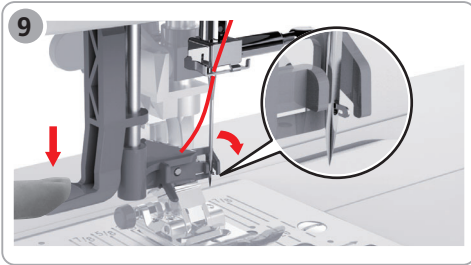
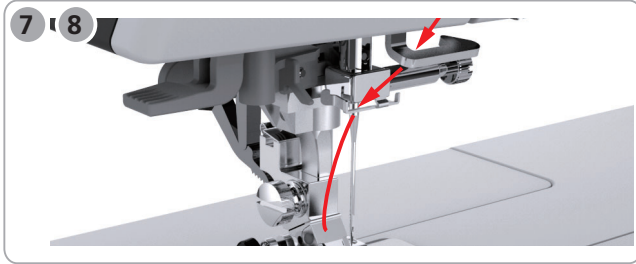
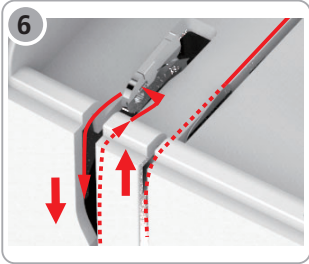
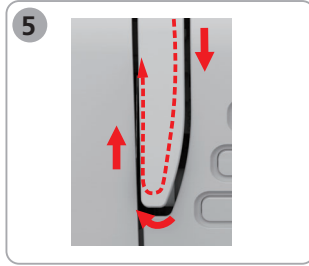
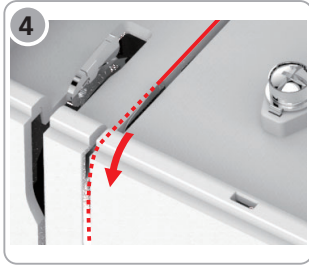
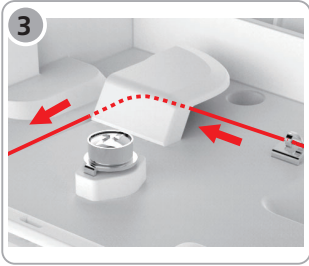

# Overview selection menu

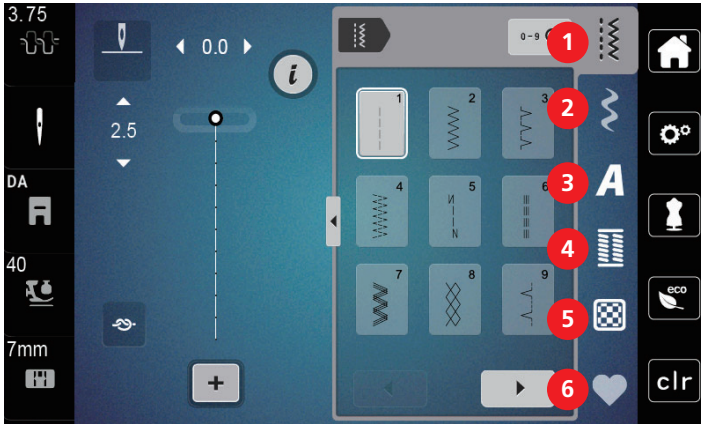

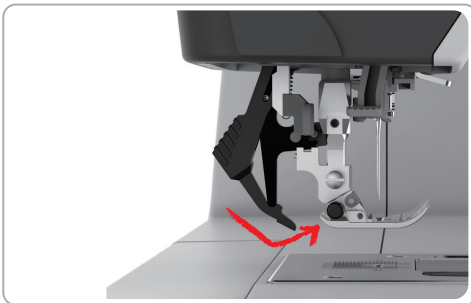
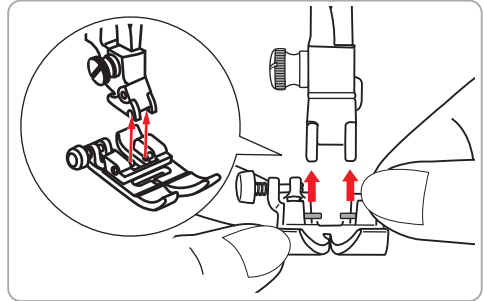
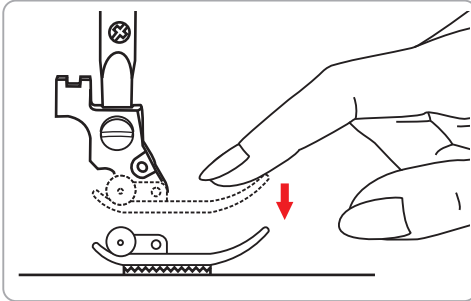

- 1 Practical stitches
- 2 Decorative stitches
- 3 Alphabets
- 4 Buttonholes
- 5 Quilt stitches
- 6 Personal memory

# Changing the presser foot









For complete instructions, you can link to  
the online user manual and how to videos  
[www.mybernette.com/b77](http://www.mybernette.com/b77) or scan  
the QR-Code with your smart phone.



[www.mybernette.com/b77](http://www.mybernette.com/b77)

5200077.00A.04 / 026CJB0125 | en 2018-09  
© BERNINA International AG  
Steckborn CH, [www.bernina.com](http://www.bernina.com)