



b70
DECO



bernette

SWISS DESIGN

Table of Contents

IMPORTANT SAFETY INSTRUCTIONS	4	Horizontal spool pin	23
Important information	6	Second spool pin	24
1 My bernette Embroidery	8	2.3 Attaching the Module	25
1.1 Overview Machine	8	2.4 Embroidery foot	26
Overview front controls	8	Attaching the embroidery foot	26
Overview front	10	Selecting the embroidery foot	27
Overview top	11	2.5 Needle	27
Overview back	11	Inserting the embroidery needle	27
Overview Embroidery module	12	2.6 Threading	28
1.2 Accessory	13	Threading preparation	28
Included accessories	13	Threading the upper thread	28
Overview presser feet	14	Winding the bobbin thread	31
1.3 Overview User Interface	14	Threading the bobbin thread	33
Overview functions/visual information	14	2.7 Selecting the embroidery motif	35
Overview System settings	15	2.8 Embroidery hoop	35
Overview Selection menu embroidery	15	Overview embroidery hoop selection	35
Overview Functions and Views	15	Selecting the embroidery hoop	36
1.4 Needle, Thread, Fabric	17	Tear-away stabilizers	36
Overview Needles	17	Cut-away stabilizers	36
Example for needle description	17	Using adhesive spray	36
Thread selection	18	Using spray starch	36
Needle/thread combination	18	Using iron-on interfacing	37
1.5 Important Embroidery information	19	Using paper-backed adhesive stabilizer	37
Upper thread	19	Using water-soluble stabilizer	37
Bobbin thread	19	Preparing the embroidery hoop	37
Choosing the embroidery motif	20	Attaching the hoop	39
Embroidery test	20	Overview Embroidery functions	40
Embroidering motifs by third-party providers	20	Locating the center of the embroidery motif	40
Underlay stitches	20	Center the needle to the embroidery hoop	40
The size of the embroidery motif	20	Embroidery arm return	41
Satin or Leaf stich	21	Grid on/off	41
Step stitch	21	3 Setup Program	42
Connecting stitches	21	3.1 Embroidery settings	42
2 Embroidering preparation	22	Adjusting the upper thread tension	42
2.1 Connection and Switching on	22	Adjusting the maximum embroidering speed	42
Connecting the machine	22	Calibrating the embroidery hoop	42
Use of the power cable (only USA/Canada)	22	Deactivating securing stitches	43
Switching the machine on	22	Adjusting the thread cut	43
Fixing the touchscreen pen	22	Adjusting the height of the embroidery presser foot	44
2.2 Spool pin	23	3.2 Selecting personal settings	44
		3.3 Monitoring functions	45

Table of Contents

Activating the upper thread indicator	45	5.8	Changing the colors of the embroidery motif	60
Activating the bobbin thread indicator	45		Overview changing the color	60
3.4	Sound on/off	45	Changing the colors	61
3.5	Machine settings	45	Changing the thread brand	61
	Adjusting the brightness of the display	45	5.9	Embroidering the embroidery motif
	Calibrating the display	46		Overview Embroidery menu
	Back to basic setting	46		Adding basting stitches
	Updating the machine Firmware	47		Moving the hoop
	Checking the firmware version	47		Embroidery sequence control when thread breaks
	Reviewing the total number of stitches	48		Cutting connecting stitches
	Selecting a language	48		Multi-colored embroidery motif on/off
4	System settings	49		Color indication
4.1	Calling up the tutorial	49	5.10	Administering embroidery motifs
4.2	Using eco mode	49		Administering embroidery motifs
4.3	Cancelling any alterations with «clr»	49		Saving embroidery motifs in the personal memory
5	Creative embroidering	50		Saving the embroidery motif on the USB stick
5.1	Overview embroidering	50		Overwriting the embroidery motif in the personal
	Selecting and changing the embroidery motif	50		memory
	Overview Editing embroidery motif	51		Overwriting the embroidery motif in the personal
	Moving the embroidery motif	51		memory
5.2	Selecting and changing the embroidery motif	52		Loading an embroidery motif from the personal
5.3	Checking the embroidery time and the embroidery			memory
	motif size	52		Loading an embroidery motif from the USB stick
5.4	Regulating the speed	52		Deleting an embroidery motif from the personal
5.5	Editing the embroidery motif	53		memory
	Overview Editing embroidery motif	53		Deleting an embroidery motif from the USB stick
	Scaling up the embroidery motif view	53	6	Embroidery
	Downsizing the embroidery motif	53	6.1	Embroidering via the button «Start/Stop»
	Moving the embroidery motif view	54	6.2	Increasing the embroidery speed
	Moving the embroidery motif in enlarged view	54	6.3	Adjusting the upper thread tension
	Moving the embroidery motif	54	7	BERNINA CutWork Tool
	Rotating motif	55	7.1	Changing the CutWork Tool
	Altering the embroidery motif size proportionally	55	7.2	Start to cut
	Mirroring embroidery motifs	55	8	Appendix
	Checking the size and the position of the embroidery		8.1	Maintenance and cleaning
	motif	56		Cleaning and maintenance intervals
	Deleting an embroidery motif	56		Cleaning the display
5.6	Creating lettering	57		Cleaning the hook
	Overview embroidery alphabets	57		Oiling the needle bar
	Creating words/sentences	57	8.2	Troubleshooting
	Editing words/sentences	58	8.3	Error messages
	Bending the text	59	8.4	Technical data
	Altering the stitch density	59	9	Overview stitch patterns
5.7	Combining embroidery motifs	60	9.1	Overview Embroidery motifs
	Combining embroidery motifs	60		Editing the embroidery motif
	Deleting a single embroidery motif	60		

Embellishment	79
Quilt motifs	82
Borders and Lace	83
Children	84
Flowers	86
Seasons	88
Asia	90
Sport/Hobby	90
Animals	93
Cutwork	95
Campaign	96
Index	97

IMPORTANT SAFETY INSTRUCTIONS

Please be aware of the following basic safety instructions when using your machine. Before using this machine, read instruction manual carefully.

DANGER!

To reduce the risk of electrical shock:

- Never leave the machine unattended as long as it is plugged in.
- Always unplug the machine from the electrical outlet immediately after using.

Protection against LED radiation:

- Do not view the LED light directly with optical instruments (e.g. magnifier). The LED light corresponds with protection class 1M.
- When the LED light is damaged or defective, contact your bernette specialist dealer.

WARNING

To reduce the risk of burns, fire, electric shock or injury to persons:

- To operate the machine always use the supplied power cable. USA and Canada only: Do not connect power plug NEMA 1-15 to circuits exceeding 150 volt-to-ground.
- This machine may only be used for the purpose described in this instruction manual.
- Only use the machine in dry rooms.
- Do not use the machine in a damp condition or in a damp environment.
- Do not use this machine as a toy. Increased caution is advised when the machine is used by or near children.
- This machine may be used by children eight years of age and older as well as persons with restricted physical, sensory or mental capacities or lack of experience and knowledge under supervision or having received instruction on the safe use of the machine and the resulting hazards.
- Children are not allowed to play with the machine.
- Cleaning and maintenance work must not be carried out by children unless they are supervised.
- Do not use this machine if the cable or plug is damaged, the machine is not functioning correctly, it is dropped or becomes damaged or falls in water. Return the machine to your local authorized bernette dealer for examination or repair.

- Only use accessories recommended by the manufacturer.
- Do not use this machine if the ventilation openings are blocked. Keep the ventilation openings free from the accumulation of lint, dust and loose cloth.
- Never insert any objects into any openings of the machine.
- Do not operate the machine where aerosol products (sprays) or oxygen are being used.
- Keep fingers away from all moving parts. Special care should be taken in the area of the needle.
- Turn the power switch to «0» when making any adjustments in the needle area, such as threading the needle, changing the needle, threading the hook or changing the presser foot.
- Do not use bent needles.
- Always use a original bernette stitch plate. The wrong stitch plate can cause needle breakage.
- To disconnect, turn power switch to "0" and then remove the plug from the outlet. Always pull the plug and not the cable.
- Always disconnect the power plug from the electrical outlet when the covers are removed or opened, when the machine is lubricated or during any other maintenance adjustments mentioned in the instruction manual.
- This machine is double-insulated (except for USA, Canada and Japan). Use only identical replacement parts. Take note of the instructions for the maintenance of double-insulated products.
- The sound pressure level under normal conditions is less than 70 dB (A).

Important information

Availability of the instruction manual

The short manual is part of the machine.

- Keep the short manual of the machine in a suitable place near the machine and have it ready for reference.
- A detailed instruction manual can be downloaded from www.mybernette.com.
- When passing on the machine to a third party, enclose the short manual of the machine.

Proper use

Your bernette machine is conceived and designed for private household use. It answers the purpose to embroider fabrics and other materials as it is described in this instruction manual. Any other use is not considered proper. bernette assumes no liability concerning consequences resulting from an inappropriate usage.

Equipment and scope of delivery

Example images are used in these operating instructions for the purposes of illustration. The machines shown in the images and the accessories shown therefore do not always match the actual items included with your machine. The supplied accessory can vary depending on the country of delivery. Accessories mentioned or shown, which are not included in the scope of delivery, can be purchased as optional accessories from a bernette specialized dealer. Further accessories can be found at www.mybernette.com.

For technical reasons and in order to improve the product, changes may be made to the equipment of the machine and the scope of delivery at any time and without prior notice.

Maintenance of double-insulated products

In a double-insulated product, two systems of insulation are provided instead of grounding. No grounding means is provided on a double-insulated product nor should a means for grounding be added to the product. Servicing a double-insulated product requires extreme care and knowledge of the system and should only be done by qualified service personnel. Only original spare parts should be used for service and repairs. A double-insulated product is marked with the words: «Double-Insulation »or «double-insulated».

 The symbol may also be marked on the product.

Environmental Protection

BERNINA is committed to the protection of the environment. We strive to minimize the environmental impact of our products by continuously improving product design and our technology of manufacturing.



The machine is labeled with the symbol of the crossed-out wastebin. This means that the machine should not be disposed of in household waste when it is no longer needed. Improper disposal can result in dangerous substances getting into the groundwater and thus into our food chain, damaging our health.

The machine must be returned free of charge to a nearby collection point for waste electrical and electronic equipment or to a collection point for the reuse of the machine. Information on the collection points can be obtained from your local administration. When purchasing a new machine, the dealer is obliged to take back the old machine free of charge and dispose of it properly.

If the machine contains personal data, you are responsible for deleting the data yourself before returning the machine.

Explanation of symbols



Designates a high-risk hazard which can lead to serious injuries or potentially even death if not avoided.



Designates a medium-risk hazard which can lead to serious injuries if not avoided.



Designates a low-risk hazard which can lead to minor or moderate injuries if not avoided.



Designates a hazard which can lead to material damage if not avoided.

1 My bernette Embroidery

1.1 Overview Machine







Overview front controls



- | | | | |
|---|-------------------------|----|--|
| 1 | Sewing light | 6 | Needle up/down |
| 2 | Thread cutter | 7 | Upper Multifunction knob |
| 3 | Presser foot up/down | 8 | Lower Multifunction knob |
| 4 | Start/Stop | 9 | Motif center |
| 5 | Checking the motif size | 10 | Center the needle to the embroidery hoop |

Operating components

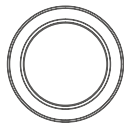
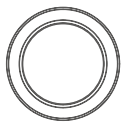
Number	Operating component	Name	Purpose
1		Sewing light	To switch the sewing light on or off, push the button «Sewing light».

Number	Operating component	Name	Purpose
2		Thread cutter	<ul style="list-style-type: none"> > To cut the upper thread and bobbin thread automatically, touch «Thread cutter».
3		Presser foot up/down	<ul style="list-style-type: none"> > To bring the presser foot into the hover position, push «Presser foot up/down». > To lift the presser foot, push «Presser foot up/down».
4		Start/Stop	<p>The button «Start/Stop» is used to change the presser foot position and to start the machine.</p> <ul style="list-style-type: none"> > To start the machine, keep the button «Start/Stop» pressed for 2 seconds. > To bring the presser foot into its highest position, press «Start/Stop» briefly. > To bring the presser foot into the hover position, press «Start/Stop» again.
5		Checking the motif size	<ul style="list-style-type: none"> > To position the embroidery hoop according to the needle position on the display, press the button «Check motif size».
6		Needle up/down	<ul style="list-style-type: none"> > To thread the bobbin thread, press «Needle up/down».
7		Upper Multifunction knob	Use the «Upper Multifunction knob» to change the setting values in the embroidery and setup program.
8		Lower Multifunction knob	Use the «Lower Multifunction knob» change the setting values in the embroidery and setup program.
9		Motif center	<ul style="list-style-type: none"> > to position the hoop so that the needle is placed exactly above the center of the embroidery motif, touch the icon «Center of the embroidery motif».
10		Center the needle to the embroidery hoop	<ul style="list-style-type: none"> > To facilitate the threading of the needle and to get enough free space from the needle to the embroidery frame, touch the icon «Center the embroidery frame to the needle».

Overview front



- | | | | |
|---|----------------------------------|----|----------------------|
| 1 | Connection for embroidery module | 7 | Thread cutter |
| 2 | Stitch plate cover | 8 | Slide speed control |
| 3 | Stitch plate | 9 | Thread take-up lever |
| 4 | Embroidery foot | 10 | Top cover |
| 5 | Sewing light | 11 | LCD Display |
| 6 | Needle threader | | |

Overview top

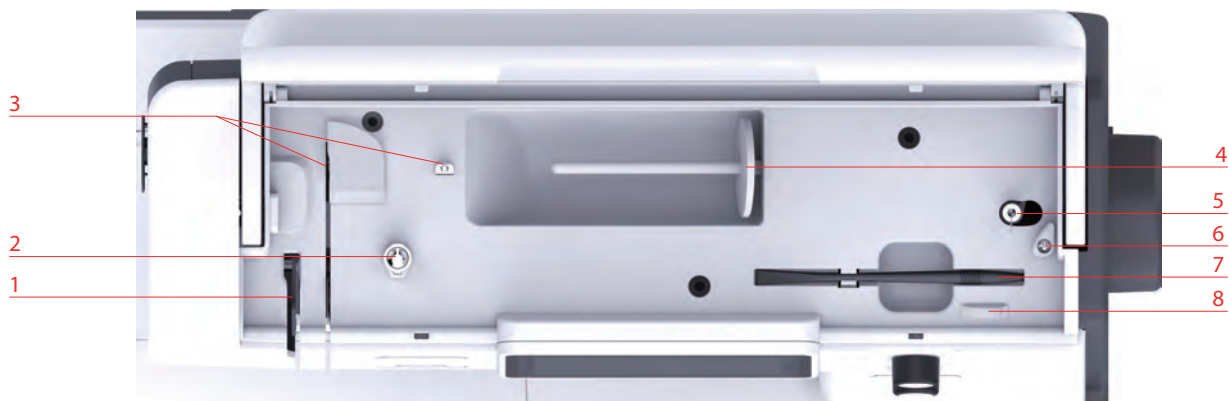

- | | | | |
|---|----------------------|---|--|
| 1 | Thread take-up lever | 5 | Winding unit and holder for second spool pin |
| 2 | Thread pretension | 6 | Stopper winding unit |
| 3 | Thread guide | 7 | Touchscreen pen |
| 4 | Spool pin | 8 | Thread cutter |

Overview back

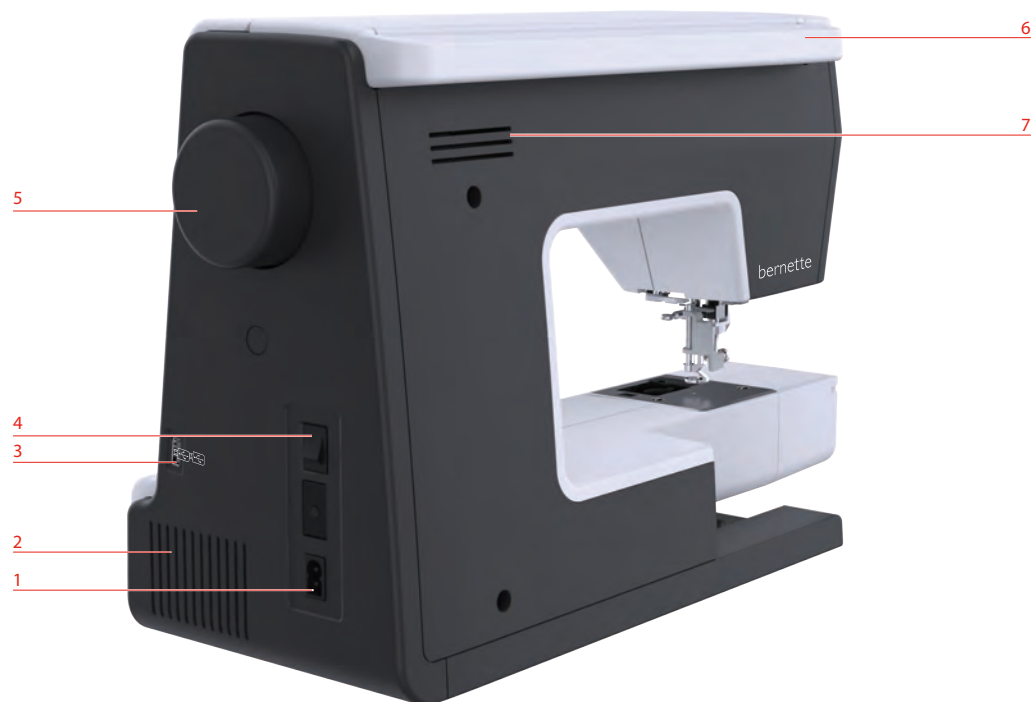

- | | | | |
|---|----------------------------|---|-----------------|
| 1 | Connection for power cable | 5 | Handwheel |
| 2 | Air vents | 6 | Carrying handle |
| 3 | USB port | 7 | Air vents |
| 4 | Power switch | | |

Overview Embroidery module

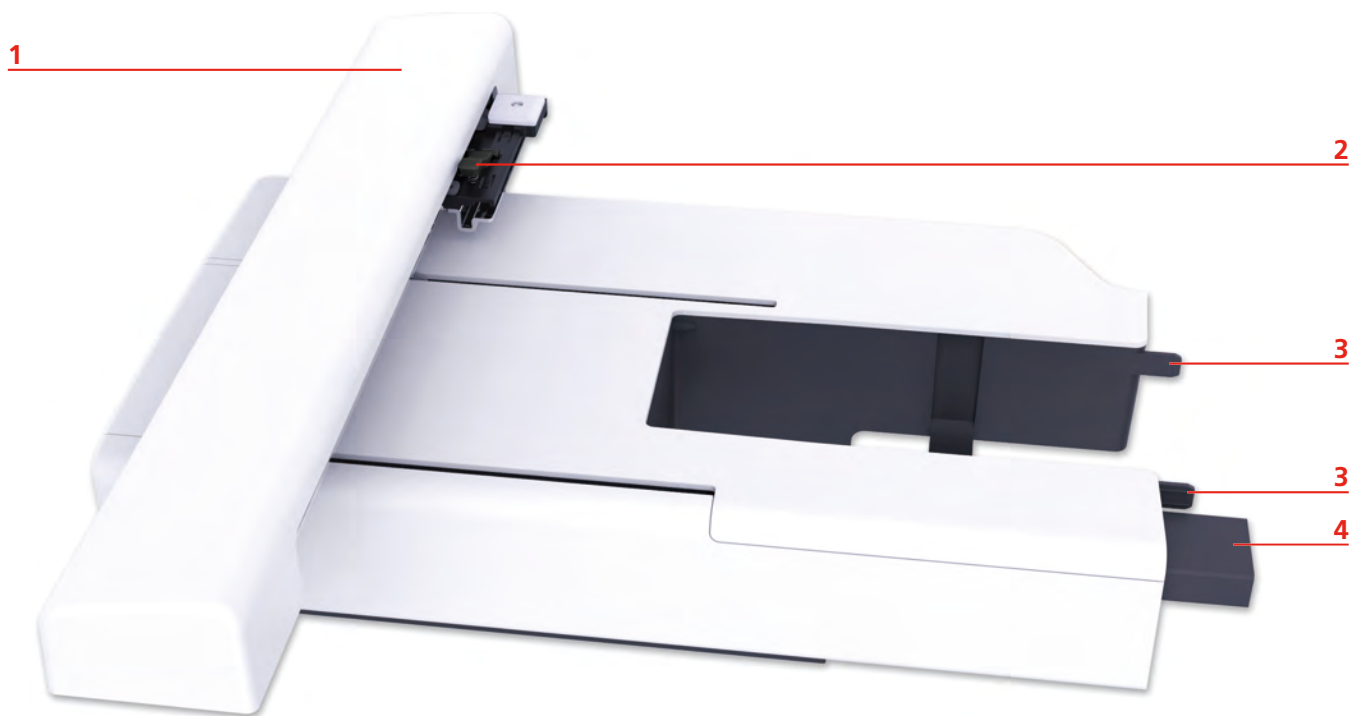

- | | | | |
|---|---|---|--------------------------------|
| 1 | Embroidery arm | 4 | Connection to the machine |
| 2 | Bracket for attaching the embroidery hoop | 5 | Embroidery unit release button |
| 3 | Guide rails for the machine | | |











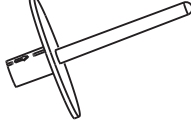

1.2 Accessory

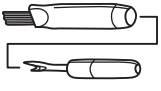
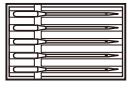
All rights reserved: For technical reasons and for the purpose of product improvements, changes concerning the features of the machine can be made at any time and without advance notice. The supplied accessory can vary depending on the country of delivery.

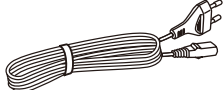
Included accessories

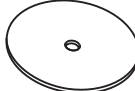
Visit www.mybernette.com/accessories for more accessory information.

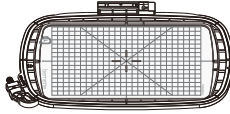
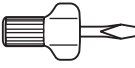
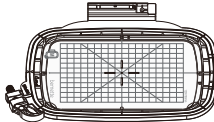
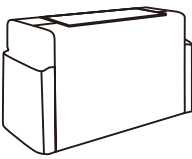
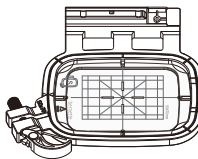

Illustration	Name	Illustration	Name
	Bobbin (3x)		Second spool pin
	Spool net		Touchscreen pen
	Brush/ Seam ripper		Selection of needles
	Spool disc large		Power cable
	Spool disc middle (1x)		Felt disc
	Spool disc small		Embroidery hoop large, 160 x 260 mm with embroidery template
	Screwdriver		Embroidery hoop medium, 120 x 180 mm with embroider template
	Dust cover		Embroidery hoop small, 50 x 70 mm with embroidery template
	Lubricator		

Overview presser feet

Illustration	Name	Purpose
	Hopper embroidery foot (JX)	To embroider
	Embroidery foot (JL)	To embroider

1.3 Overview User Interface

Overview functions/visual information

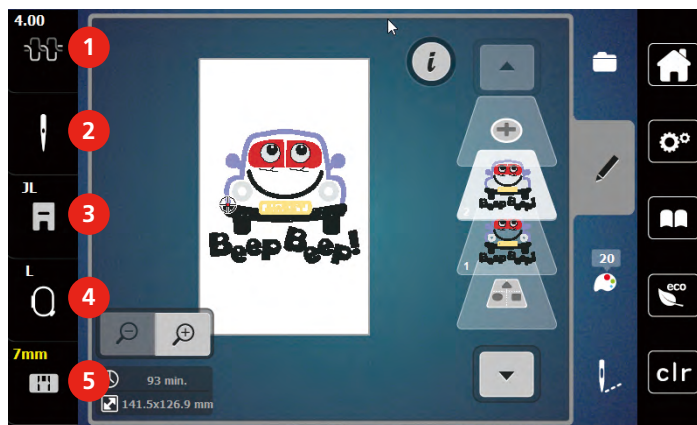

- | | | | |
|---|---|---|---|
| 1 | Upper thread tension | 4 | Embroidery hoop display/Embroidery hoop selection |
| 2 | Needle selection | 5 | Stitch plate display |
| 3 | Embroidery foot display/Embroidery foot selection | | |

Overview System settings



- | | | | |
|---|---------------|---|-------------------------|
| 1 | Home | 4 | eco mode |
| 2 | Setup Program | 5 | Back to default setting |
| 3 | Tutorial | | |



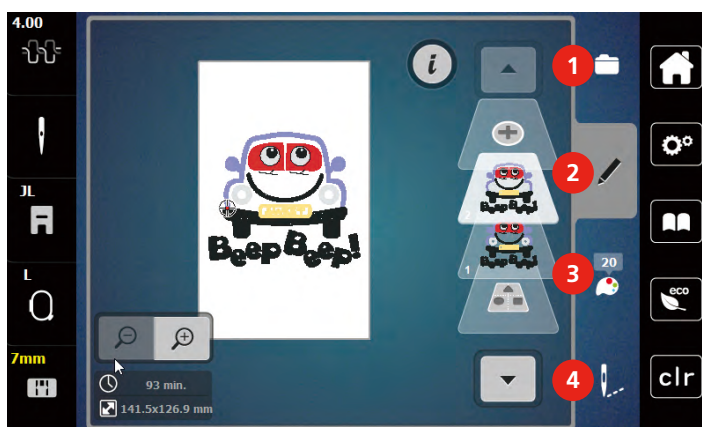





Overview Selection menu embroidery



- | | | | |
|---|-----------------------------|---|-------------------|
| 1 | Selection embroidery motifs | 3 | Color information |
| 2 | Editing embroidery motifs | 4 | Embroidery |

Overview Functions and Views

Illustration	Name	Purpose
	Close	The display is closed and the previously made adjustments are saved.
	Icons «-/+»	By touching the icons «-» and «+» the setting values are changed.
	Confirm	Confirms the previously adjusted alterations. The display is closed.

Illustration	Name	Purpose
	Cancel	The process is canceled. The display is closed and the previously made adjustments are not saved.
	Slide	By moving the slide the setting values are changed.
	Switch	Activates or deactivates functions.
	Process navigation	With the process navigation, you can return from any display to the previous the display.
	Machine	To load or save motifs on the machine.
	USB stick	To load or save embroidery motifs on the USB stick.
	USB storage space	The percentage of used USB storage (%) will be displayed in the green bar icon.
	Swipe function	By swiping the display using the touchscreen pen or the finger upwards or downwards, further functions can be displayed.
	Yellow-framed icon	Touch the yellow-framed icon to reset the alterations to default setting.

1.4 Needle, Thread, Fabric

In the course of time a needle wears out. Therefore, the needle should be replaced regularly. Only a perfect point results in a good stitching result. In general it can be said: the thinner the thread, the finer the needle. The illustrated needles are either standard or optional accessory, depending on the machine.

- Needle sizes 70, 75: for light-weight fabrics.
- Needle sizes 80, 90: for medium fabrics.
- Needle sizes 100: for heavy fabrics.

Overview Needles

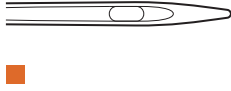
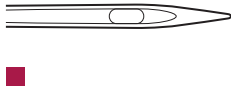
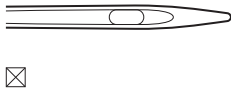
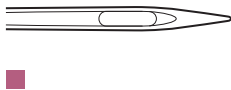
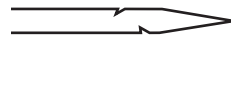
Illustration	Needle name	Needle description	Purpose
	Jersey/Embroidery needle 130/705 H SUK 60-100	Mid-sized ball point	For knitware, knitted good. For embroidering.
	Embroidery needle 130/705 H-E 75, 90	Small ball point, especially wide needle eye and wide thread groove	For embroidery on all natural and synthetic fabrics.
	Fine-material needle 130/705 H SES 70, 90	Small ball point	For fine knitware and knitted materials. For embroidery on fine, delicate fabrics.
	Metafil needle 130/705 H METAFIL 80	Long needle eye (2 mm) in all needle sizes	For sewing or embroidering with metallic threads.
	Felt needle PUNCH	Needle with barbed hook	For felt work.

Example for needle description

The 130/705 system, which is the most common for household machines, is explained by the following picture of a Jersey/Stretch needle.

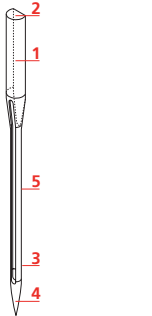
	<p>130/705 H-S/70</p> <p>130 = Shank length (1)</p> <p>705 = Flat shank (2)</p> <p>H = Needle scarf (3)</p> <p>S = Needle point (here medium ball point) (4)</p> <p>70 = Needle size 0.7 mm (5)</p>
---	---

Thread selection

For a perfect sewing result, thread and fabric quality play an important role.

We recommend purchasing quality threads to achieve good sewing results.

- Cotton threads have the advantage of being a natural fiber and therefore are especially suitable for sewing cotton fabrics.
- Mercerized cotton threads have a slight sheen that is not lost with washing.
- Polyester threads have a high tensile strength and is particularly colorfast.
- Polyester threads are more flexible and are recommended where a strong and elastic seam is required.
- Rayon threads are made of natural fibers and have a brilliant sheen.
- Rayon threads are suitable for decorative stitches and achieve a more beautiful effect.

Needle/thread combination

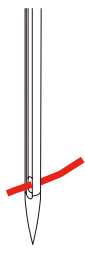
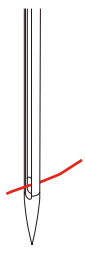
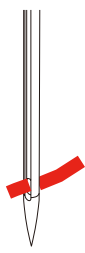
	<p>The needle/thread combination is correct, when the thread fits perfectly into the long groove and goes easily through the needle eye. The thread can be optimally sewn.</p>
	<p>The thread can break and cause skipped stitches if there is too much play in the long groove or eye of the needle.</p>
	<p>The thread can break and become jammed if it frays on the edges of the long groove and is not guided optimally through the eye of the needle.</p>

1.5 Important Embroidery information

Upper thread

A good quality thread (brand manufacturer) is essential for embroidery so that the embroidery is not affected negatively because of poor thread or thread breakage.

Embroidery is particularly effective if you use 40wt glossy rayon or polyester embroidery threads as upper threads. They are available in a wide range of colors for beautiful embroidery.

- Glossy polyester with a brilliant sheen is a hard wearing, colorfast thread and has a high tensile strength which is suitable for all types of embroidery.
- Rayon is a soft viscose fiber with a brilliant sheen and suitable for fine, delicate embroidery, or items that will not receive excessive wear and tear.
- Metallic thread is a light to medium-weight thread suitable for special effects in embroidery.
- When working with metallic threads, the automatic bobbin thread cutter should be deactivated. The other thread cutters shouldn't be used either because the knives are likely to wear off very quickly.
- When using metallic threads, the speed and the upper thread tension should be reduced.



Bobbin thread

In most cases black or white bobbin thread is used for embroidering. When both sides should have the same look, it is recommended to use the same color for bobbin and upper thread.

- Bobbin Fill is an especially soft and light polyester thread which is suited well to be used as bobbin thread. This special bobbin thread ensures a steady thread tension and an optimal intertwining of the upper and bobbin thread.
- Darning and embroidery threads are fine mercerized cotton threads which are suitable for embroidery on cotton.



Choosing the embroidery motif

Simple motifs with a low stitch count are suitable for embroidery on fine material. Densely embroidered motifs, e. g. embroidered motifs with multiple color and embroidery direction changes, are suitable for medium and heavy-weight material.

Embroidery test

For the embroidery test, always use the original material reinforced with the same stabilizer as will be used later. For the embroidery test it is recommended to use the same colors, threads and needles which are planned to be used for the embroidery project.

Embroidering motifs by third-party providers

bernette recommends loading embroidery designs of any file format onto the machine or onto a USB stick using the free program «ART-Link» or the «BERNINA Toolbox». «ART-Link» ensures that embroidery designs are read and embroidered correctly. «ART-Link» can be downloaded for free at www.bernina.com.

Underlay stitches

Underlay stitches are the foundation of a motif and are used to stabilize the base material and hold it in shape. They also prevent the covering stitches of the motif from sinking into the knit or the nap of the material.

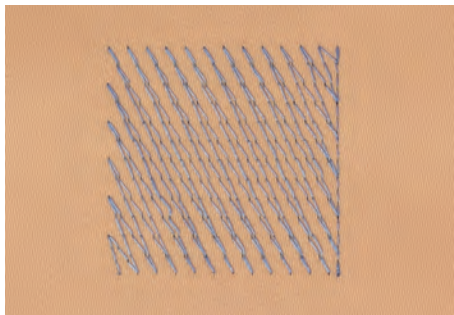

The size of the embroidery motif

Embroidery motifs can be enlarged or downsized on the embroidery machine or on the PC using the BERNINA Embroidery software (optional accessory). Enlargements or reductions up to 20% achieve the best results.

Satin or Leaf stitch

The needle moves left to right and vice versa. The result is a very dense, covering zig zag stitching to fill the shape. Satin stitching fills are ideal for narrow and small shapes. Satin stitching is, however, not suitable for larger areas, since wide stitches are too loose and do not cover the fabric properly. In addition there is the risk that with too long stitches the threads could catch on something which would damage the embroidery.

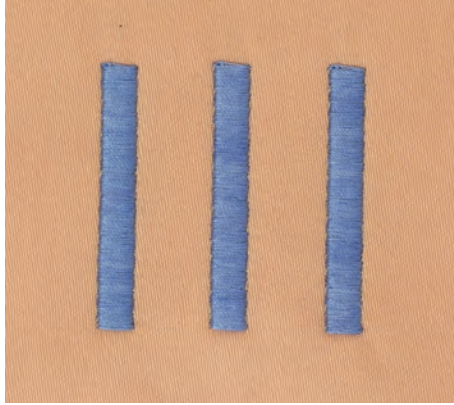

Step stitch

Many short, equally long stitches are embroidered in offset rows closely next to each other which results in a densely filled area.

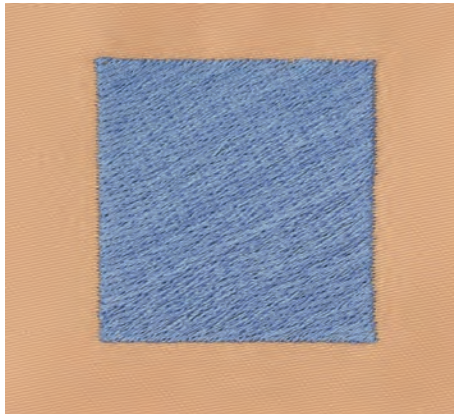

Connecting stitches

Long stitches which are used to get from one part of the motif to the next. Before and after the connecting stitch securing stitches are sewn. Connecting stitches are trimmed.

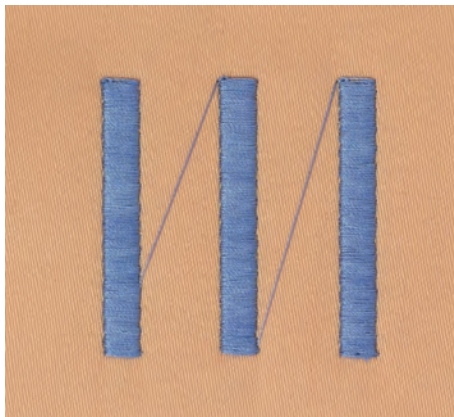

2 Embroidering preparation

2.1 Connection and Switching on

Connecting the machine

- > Insert the power cable into the power cord connection.



- > Insert the power cable into the power cord connection.

Use of the power cable (only USA/Canada)

The machine has a polarized plug (one contact is wider than the other). To reduce the risk of electric shock, the plug can only be plugged into the socket in one way. If the plug does not fit into the socket, turn the plug. If it still does not fit, contact an electrician to install an appropriate outlet. Do not modify the plug in any way.

Switching the machine on

- > Switch on the machine at the main switch to «I».



Fixing the touchscreen pen

- > Store the touchscreen pen on the top holder.



2.2 Spool pin

Horizontal spool pin

Placing the thread spool and the thread disc

Spool discs hold the thread spool in place for proper release of thread from the spool. The thread disc is only used with the horizontal spool holder.

- > Place the thread spool on the spool holder.
- > Position the appropriate spool disc on the spool holder so that there is no space between the spool disc and the thread spool.

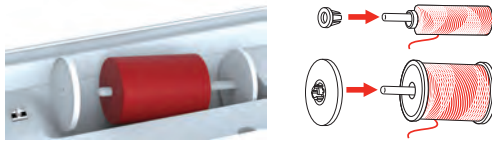

Using a spool net

The spool net provides an even unwinding of the thread from the thread spool and prevents the thread from knotting and breaking. The spool net is only used with the horizontal spool holder.

- > Pull the spool net over the thread spool.

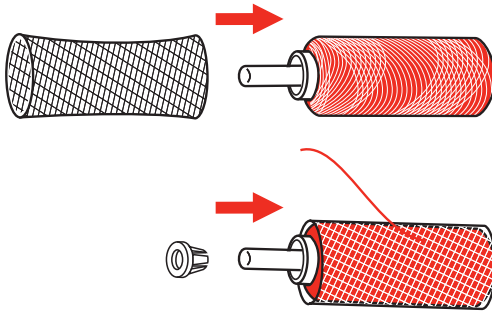

Second spool pin

Installing the second spool pin

- > Insert the second spool pin onto the end of the bobbin winding unit(1).
- > Align the notch (2) with the spring (3) on the bobbin winding unit.

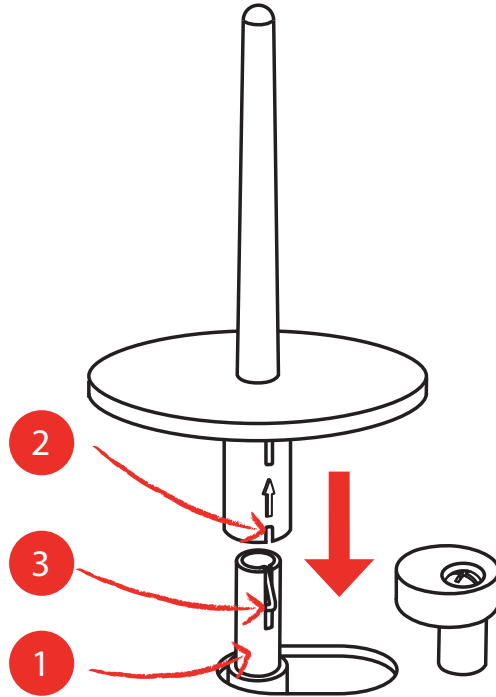

Inserting thread spool

The felt disc prevents the thread from getting hooked at the second spool pin.

- > Place the felt disc (1) on the second spool pin.
- > Place the thread spool on the second spool pin.

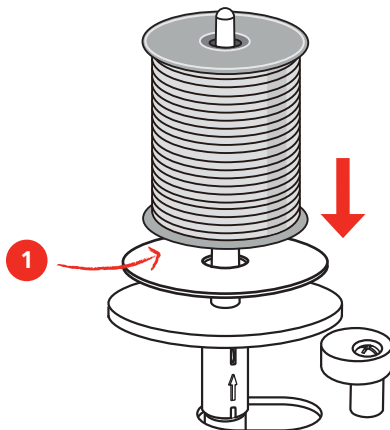

2.3 Attaching the Module

NOTICE

Transporting the embroidery module

Damage to the embroidery module connection and machine.

> Remove the embroidery module before transporting the machine.

- > Make sure that the module and the machine are placed on a stable, even surface.
- > Make sure that there is enough space around to allow the unimpeded movement of the embroidery arm.
- > Lift the embroidery module on the left.
- > Carefully push the module from left to right into the embroidery module connection (1) of the machine so that it engages.



- > Hold the embroidery module, press the release button and pull it out.



2.4 Embroidery foot

Attaching the embroidery foot

Mount the embroidery foot

- > Raise the needle.
- > Raise the presser foot.
- > Switch off the machine and disconnect it from the power supply.
- > Attach the embroidery foot (JL) from the back with the index finger to the presser foot bar and tighten the screw.

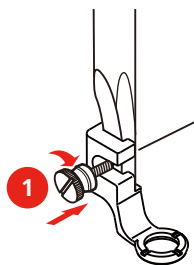

- > After starting the machine, select the embroidery foot in the «Presser foot sole display».

Mount the hopper embroidery foot

- > Raise the needle.
- > Raise the presser foot.
- > Switch off the machine and disconnect it from the power supply.
- > Attach the Hopper embroidery foot (JX) to the presser foot bar, making sure that the spring (3) is over the needle clamp screw (4).
- > Tighten the screw (1).

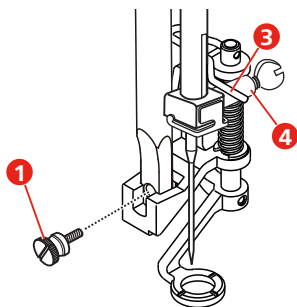

- > After starting the machine, select the embroidery foot in the «Presser foot sole display».

Selecting the embroidery foot

To ensure that the machine can set the correct standard height for the attached embroidery foot, the embroidery foot must be selected in the «Presser foot sole display».

- > Switch the machine on.
- > Touch the icon «Presser foot sole display».
 - Any presser foot soles are displayed.



- > Select the attached embroidery foot.
 - A description of the selected embroidery foot is displayed.
- > Touch the icon «Confirm».
 - The selected embroidery foot is displayed and the standard height is set.



2.5 Needle

Inserting the embroidery needle



Embroidery needles of the type 130/705 H-SUK provide a larger eye and are slightly rounded. This avoids thread abrasion when using Rayon- and cotton embroidery thread. Depending on the embroidery thread use a size No. 70-SUK to No. 90-SUK needle.

- > Raise the needle.
- > Switch off the machine and disconnect it from the power supply.
- > Remove the presser foot.
- > Loosen the needle clamp screw (1) using the screwdriver and remove the needle.
- > Hold the needle with the flat side (2) to the back.
- > Push the needle up to the stop (3).
- > Tighten the needle clamp (1) screw using the screwdriver.

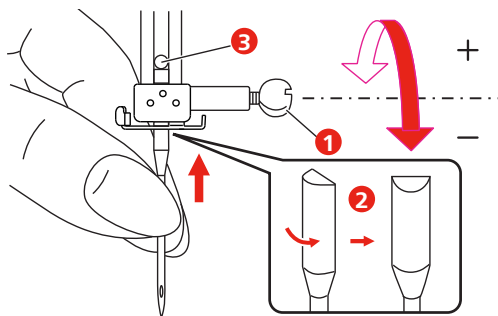

2.6 Threading

Threading preparation

- > Press the button «Presser foot up/down» to raise the presser foot.
- > Raise the presser foot.

Threading the upper thread

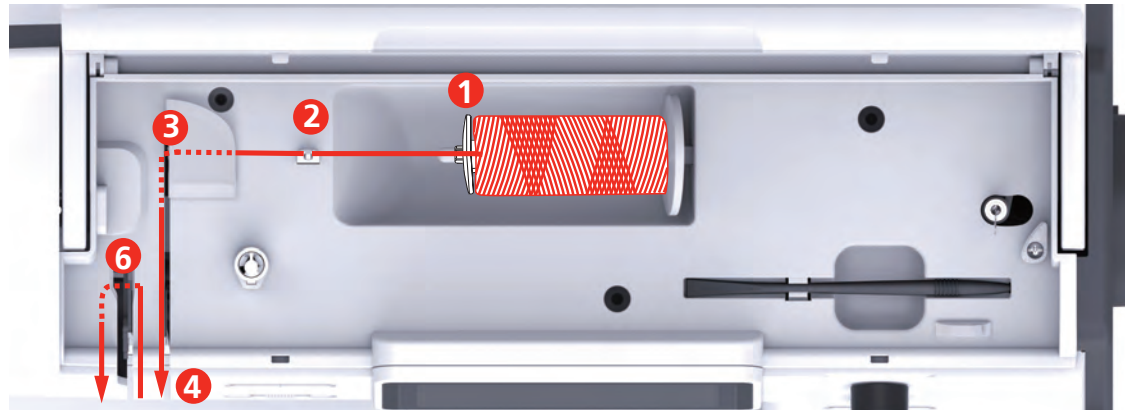

- | | | | |
|---|----------------------------|----|----------------|
| 1 | Spool disc | 7 | Guide |
| 2 | Thread guide | 8 | Guide |
| 3 | Thread guide | 9 | Threader lever |
| 4 | Thread tension discs | 10 | Wire hook |
| 5 | Thread take-up lever cover | 11 | Thread cutter |
| 6 | Thread take-up lever | 12 | Thread |

- > Place the thread spool on the spool pin so that the thread is unwound clockwise.
- > Attach the appropriate thread disc.
- > Feed the thread through the thread guide (2).

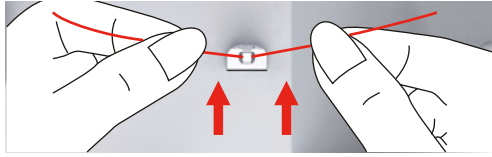

- > Feed the thread through the thread guide (3).



- > Place the end of the thread down along the duct.



- > Guide the thread downwards around the thread take-up lever cover.

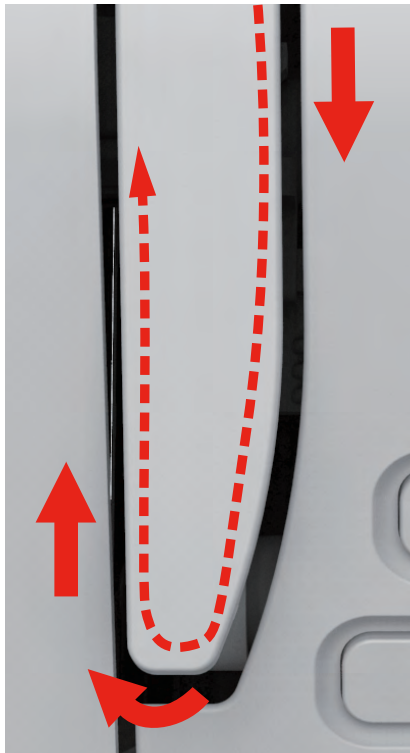

- > Guide the thread at the top from right to left through the thread take-up lever and then down again.

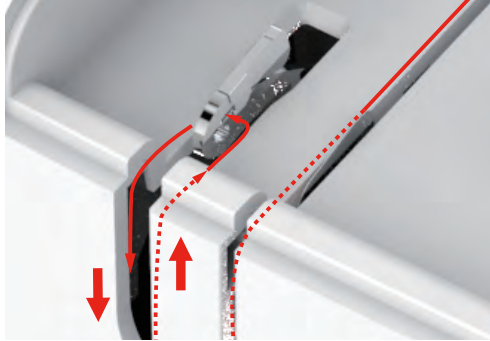

- > Pass the thread through the guides above the presser foot.
- > Lower the presser foot.

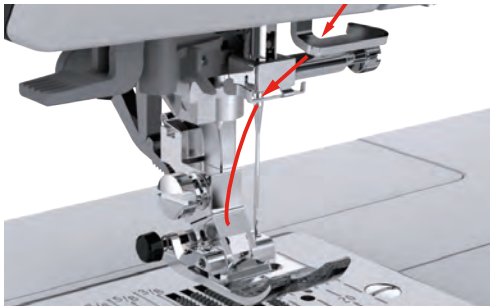

- > Press the threading lever down until it clicks into place.
 - The wire hook goes through the eye of the needle.
 - To prevent damage to the threader, the presser foot is lowered automatically.

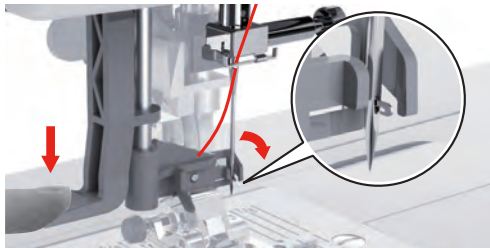

- > Feed the thread around the thread guide.
- > Bring the thread to the needle and below the wire hook.

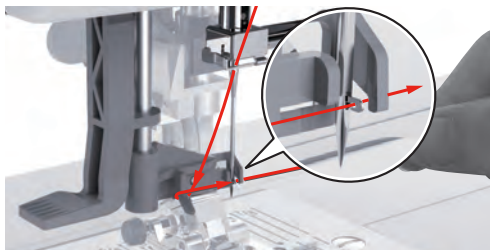

- > To cut off excess thread, take the thread end and pull it over the thread cutter. **Please note:** Use the right thread cutter only when threading.

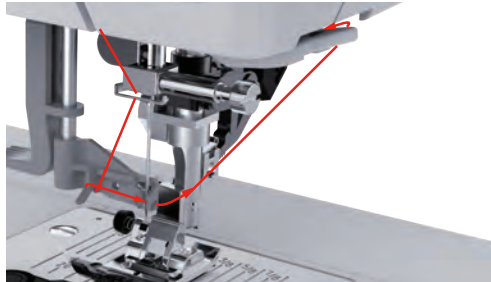
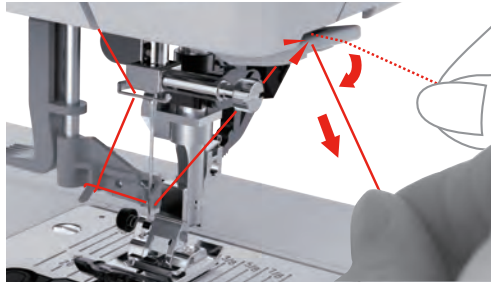

- > To thread the thread into the needle, raise the threading lever.
 - The wire hook retracts and guides the thread through the eye of the needle where it forms a loop.
- > Pull the thread completely through the eye of the needle.

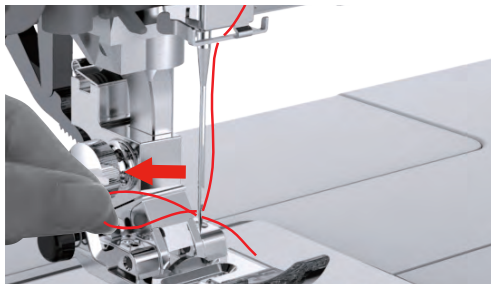

Winding the bobbin thread

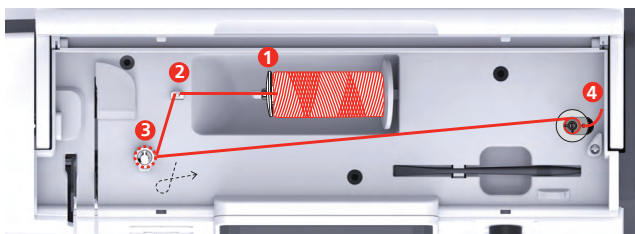

- | | | | |
|---|--------------|---|-------------------|
| 1 | Spool disc | 3 | Thread pretension |
| 2 | Thread guide | 4 | Spool pin |

- > Place the thread spool and the appropriate spool disc on the spool holder.
- > For smaller thread spools, use the small thread disc.

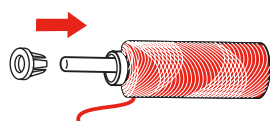

- > To prevent tangling or tearing of the thread, use the spool net.

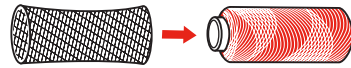

- > Feed the thread through the thread guide.

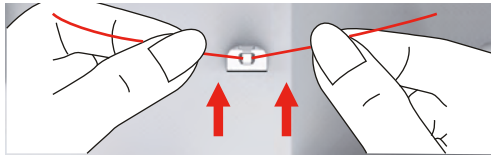

- > Wind the thread clockwise around the thread pre-tensions.

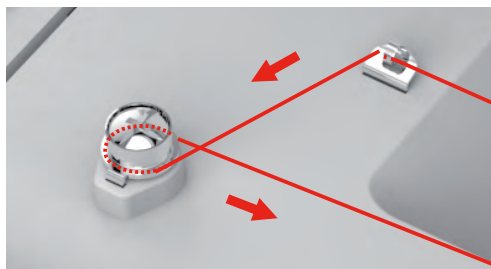

- > Pull the thread end through one of the inner holes of the bobbin and place the empty bobbin on the bobbin unit.

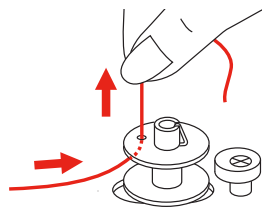

- > Push the bobbin to the right.

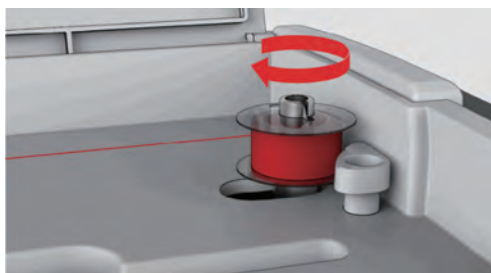

- The button «Start/Stop» flashes and the display for winding appears.



- > Hold the end of the thread with one hand.
- > To start the winding process for a few rotations and then stop, push the button «Start/Stop», so that the thread is held tight on the bobbin.

- > Cut off the thread end next to the inner hole.

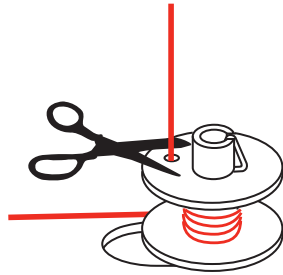

- > To continue the winding process, push the button «Start/Stop».
- > To stop the winding process, push the button «Start/Stop».
- > Remove the bobbin and cut the thread.

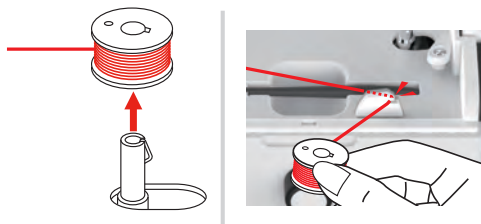

Threading the bobbin thread

Prerequisite:

- The needle is raised.
 - The presser foot is raised.
 - The machine is switched off.
- > Open the bobbin cover by pushing the release button to the right.

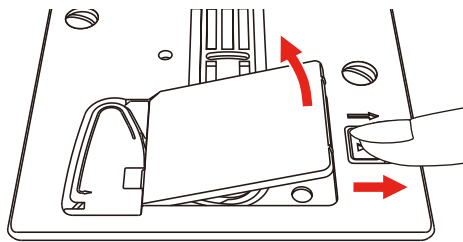

- > Insert the new spool so that the thread is wound in the counterclockwise direction.

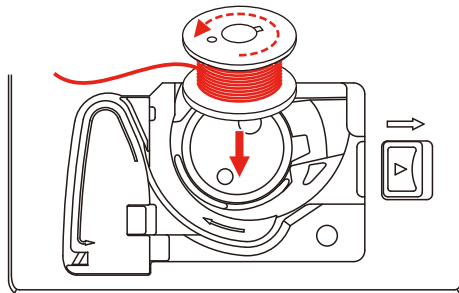

- > Pull the thread into the slit (1).

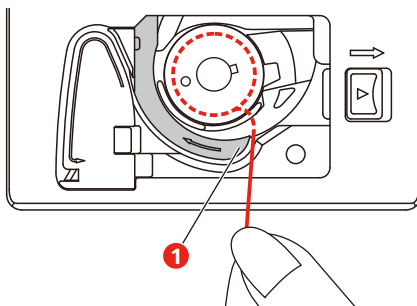

- > Press gently on the bobbin.
- > Follow the arrow markings to bring the thread into the bobbin thread guide.

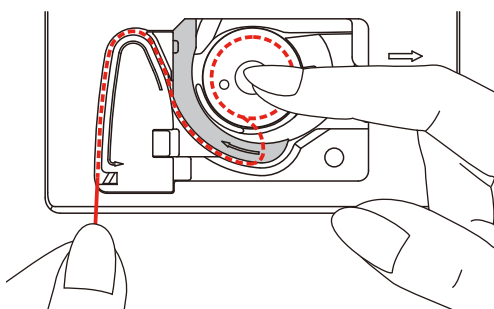

- > To cut off excess thread, take the thread end and pull it over the thread cutter (2).

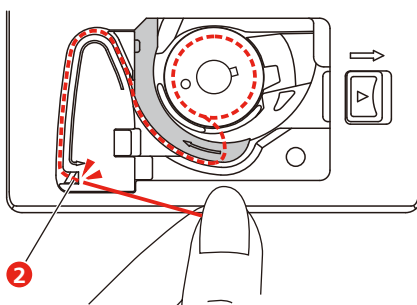

- > Close the bobbin cover.

2.7 Selecting the embroidery motif

All embroidery motifs can be embroidered directly or they can be altered using the various functions the embroidery machine provides. You can find all embroidery motifs at the end of the instruction manual. In addition to that, embroidery motifs can be downloaded from the personal memory or from the USB stick (optional accessory).



- > Touch the icon «Home».
- > Select an alphabet, an embroidery motif, a stitch pattern or a personal embroidery motif from one of the files.

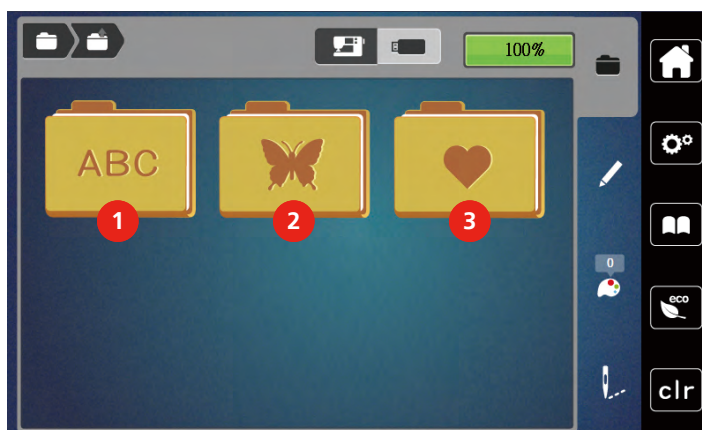

- | | | | |
|---|---------------------|---|---------------------------|
| 1 | Embroidery Alphabet | 3 | Personal Embroidery motif |
| 2 | Embroidery motif | | |

2.8 Embroidery hoop

Overview embroidery hoop selection

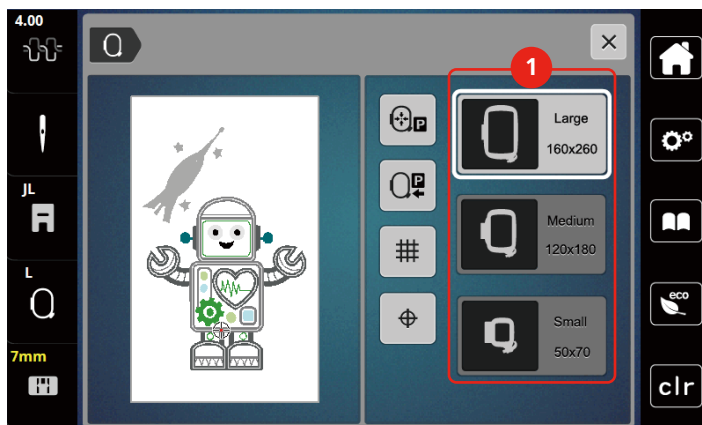

- | | |
|---|----------------|
| 1 | Hoop selection |
|---|----------------|

Selecting the embroidery hoop

The best embroidery result is achieved when the smallest possible embroidery hoop for the embroidery motif is selected.

The embroidery motif has a pre-set size which is displayed.

Prerequisite:



- The embroidery motif is selected.
- > Touch the icon «Embroidery hoop display/Embroidery hoop selection».
 - The presently attached embroidery hoop is displayed.
 - The machine selects the optimal embroidery hoop according to the size of the embroidery motif automatically.
 - If the preset embroidery hoop is not available, another desired embroidery hoop can be selected.
 - When an embroidery hoop is attached which does not correspond with the selected one, the attached hoop is considered active and the embroidery motif area is displayed accordingly.
- > Select the desired embroidery hoop.

Tear-away stabilizers

Using a stabilizer ensures more stability of the embroidery project. A tear-away stabilizer suits all woven and non-stretch materials. 1 – 2 layers can be used. Stabilizers are available in different weights. With larger embroidered areas the stabilizer will remain under the embroidery thread. The stabilizer is applied to the wrong side of the fabric with temporary adhesive spray. Carefully tear away excess stabilizer after embroidering.

Cut-away stabilizers

Using a stabilizer ensure more stability of the embroidery project. A cut-away stabilizer suits all elastic materials. 1 – 2 layers can be used. Stabilizers are available in different weights. With larger areas to be embroidered the stabilizer will remain under the embroidery thread. The stabilizer is applied to the wrong side of the fabric with temporary adhesive spray. Carefully cut away excess stabilizer after embroidering.

Using adhesive spray

The application of spray adhesive is recommended for stretch and smooth materials and knitware. It prevents the fabric from losing shape and slipping. Appliqués can be exactly positioned with spray adhesive. The spray adhesive shouldn't be used near the machine to avoid contamination.

- > Use the adhesive spray carefully at a distance 25 – 30 cm (9 – 12 inch) when spraying the stabilizer.
- > Adhere the sprayed stabilizer to the wrong side of the fabric carefully, smoothing material so there are no puckers.
- > Position smaller parts such as pocket flaps or collars on the stabilizer.
- > To avoid the possibility of getting hoop marks when working with napped materials or fleece, don't hoop the parts but spray the stabilizer and hoop it.
- > Adhere the fabric to be embroidered.
- > Remove any adhesive residue before starting the machine.

Using spray starch

Spray starch is ideal for additional stiffening fine, loosely woven materials. Always use an additional stabilizer on the wrong side of the material.

- > Spray the area to be embroidered.
- > Let it dry or press gently with a warm iron if necessary.

Using iron-on interfacing

Iron-on interfacings are available in a variety of weights. It is recommended to use an iron-on interfacing which is easily removable from the basic fabric. An Iron-on interfacing suits all materials that are easily distorted like stretch fabric such as tricot and jersey.

- > Iron-on interfacings are ironed to the wrong side of the material using a warm iron.

Using paper-backed adhesive stabilizer

Paper-backed adhesive stabilizers are intended to be used for fabrics such as jersey and silk as well as for embroidery projects which are not suited to be hooped in the embroidery hoop.

- > Place the stabilizer in the hoop, so that the paper side is up.
- > Use a pair of scissors to score the paper and remove paper in the hoop area.
- > Position the fabric to be embroidered on the stabilizer and press it on place.
- > Remove any adhesive residue before starting the machine.

Using water-soluble stabilizer



For lace embroidery it is recommended to hoop 1 – 3 layers of water-soluble stabilizer in the embroidery hoop. As the embroidery motif is not embroidered on the fabric, only the thread embroidered motif is left. The embroidery motifs should be combined with short stitches otherwise the individual motifs may fall out.

Water-soluble stabilizers are ideal for fine, sheer fabrics where other stabilizers may show through the embroidery stitches as well as for lace embroidery. The stabilizer dissolves in water. Water-soluble stabilizers are an ideal protection for looped pile fabrics preventing the loops from being damaged. It prevents threads from sinking into the material and keeps the fabric pile from poking through the embroidery.

- > Place the stabilizer on the underside of the material.
- > Use adhesive spray to adhere stabilizer if necessary.
- > For material with a pile, reinforce with additional, suitable stabilizer on the wrong side.
- > Place all the layers together into the embroidery hoop.
- > After dissolving, lay the motif down flat and let dry.

Preparing the embroidery hoop

The embroidery hoop consists of an outer and an inner hoop. There is an embroidery template for each hoop. The area to be embroidered is marked in 1 cm (0,39 in) squares. The center is marked with hole and cross lines. The required marks can be transferred to the material.

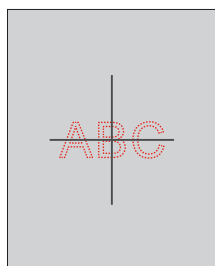

- > Loosen the screw (1) or open the quick release device (2) on the outer hoop.
 - If a new type of fabric is used, the pressure must be adjusted by turning the screw.

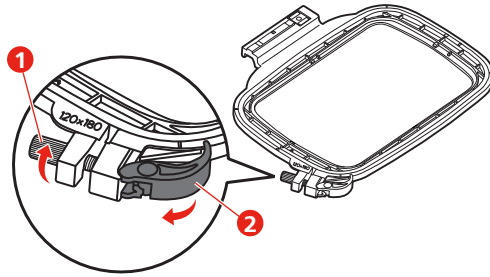

- > Remove the inner hoop.

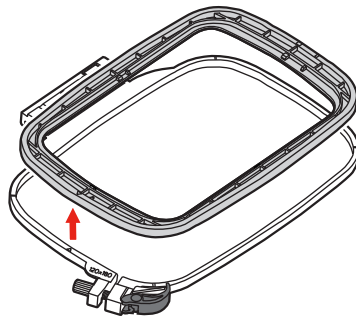

- > Place the template (1) in the inner hoop, so the bernette logo is at the front edge, and make sure the cut outs click into place.

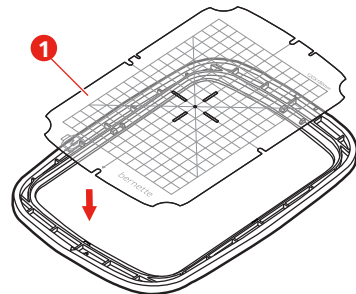

- > Place fabric under the inner frame so that it is at least 2 cm above the hoop.
- > Line up the marked center point on the center of the template.
- > Place the material and the inner hoop on the outer hoop so that the arrows of both hoops match.

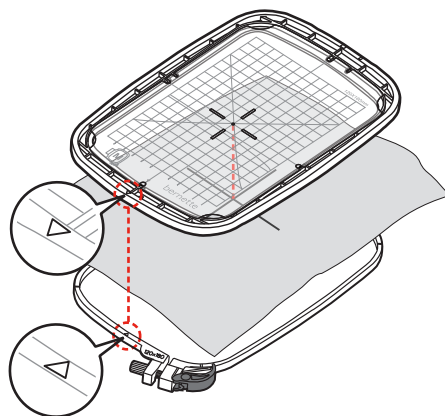

- > Fit the hoops into each other; ensure that the material does not move.
- > Hoop the fabric to be embroidered tightly.
- > Close the quick release device (2). If necessary, tighten screw (1).
- > The inner hoop should protrude about 1 mm on the underside, this prevents the hoop from sticking to the stitch plate.
- > The quick release device (2) is for changing the same type (thickness) fabric easily and quickly.
- > Remove the template (3) from the hoop.

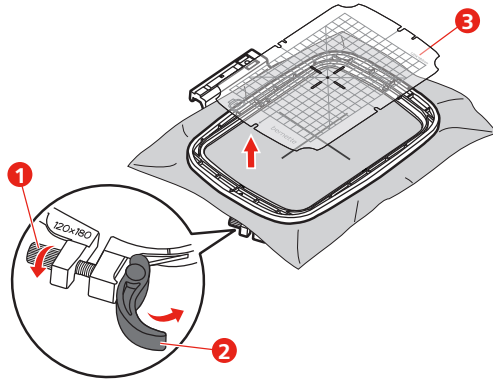

Attaching the hoop

- > Raise the needle.
- > Raise the embroidery foot.
- > Position the embroidery hoop under the embroidery foot.
- > Push the embroidery hoop into the embroidery module until it clicks into place.
 - The hoop is attached.

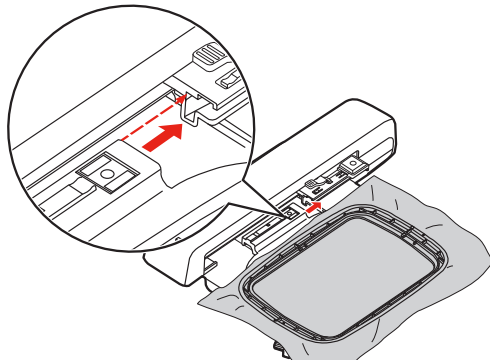

- > To remove the hoop, press the securing lever and pull the hoop backwards.

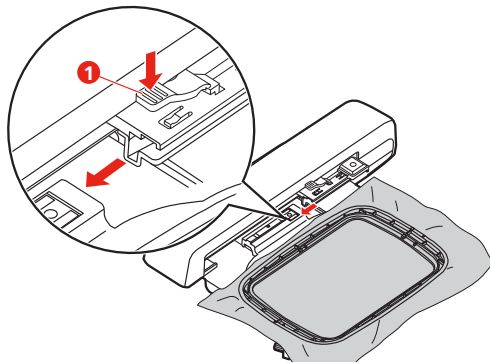

Overview Embroidery functions

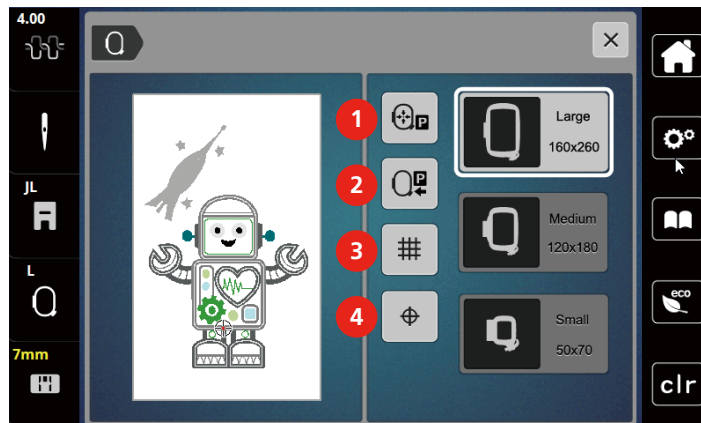

- | | | | |
|---|--|---|--------------|
| 1 | Center the needle to the embroidery hoop | 3 | Grid on/off |
| 2 | Embroidery arm return | 4 | Motif center |

Locating the center of the embroidery motif

The embroidery hoop is positioned so that the needle is exactly above the center of the embroidery motif or the motif begin.



- > Touch the icon «Embroidery hoop display/Embroidery hoop selection».



- > Touch the icon «Center of the embroidery motif» to position the hoop so that the needle is placed exactly over the center of the embroidery motif.
- > Touch the icon «Center of the embroidery motif» again to position the hoop so that the needle is placed exactly over the motif start.

Center the needle to the embroidery hoop

Relocating the embroidery hoop facilitates threading when the needle is close to the embroidery hoop.



- > Touch the icon «Embroidery hoop display/Embroidery hoop selection».



- > > Touch the icon «Center the needle to the embroidery hoop» to move the hoop to the center.
- > Thread the upper thread.



- > Push the button «Start/Stop» to move the hoop back to its previous position.

Embroidery arm return

The embroidery arm can be positioned to store the embroidery module.



- > Touch the icon «Embroidery hoop display/Embroidery hoop selection».
- > Remove the hoop.



- > Touch the icon «Embroidery arm return» the embroidery arm travels horizontally to the left to the park position.



- > Push the button «Start/Stop» to move the embroidery arm to the last position.

Grid on/off

When the center of the hoop and the grid are displayed, the embroidery motif can be positioned more exactly.



- > Touch the icon «Embroidery hoop display/Embroidery hoop selection».



- > Touch the icon «Grid on/off» to display the center of the hoop on the display.
- > Touch the icon «Grid on/off» again to display the grid.
- > Touch the icon «Grid on/off» again so that the center of the hoop and the grid disappear.

3 Setup Program

3.1 Embroidery settings

Adjusting the upper thread tension

Alterations of the upper thread tension in the Setup Program affect all embroidery motifs.



> Touch the icon «Setup Program».



> Touch the icon «Embroidery settings».



> Touch the icon «Alter the upper thread tension».

> Move the slide using the touchscreen pen/finger or touch the icons «+» or «-» to alter the upper thread tension.

Adjusting the maximum embroidering speed

By using this function, the maximum speed can be reduced.



> Touch the icon «Setup Program».



> Touch the icon «Embroidery settings».



> Touch the icon «Alter the maximum speed».

> Move the slide using the touchscreen pen/finger or touch the icons «+» or «-» to alter the maximum speed.

Calibrating the embroidery hoop

The calibration of the embroidery hoop is the coordination of the needle to the center of the embroidery hoop.

Prerequisite:

- The embroidery module is connected and the embroidery hoop with the appropriate embroidery template is attached.



> Touch the icon «Setup Program».



> Touch the icon «Embroidery settings».



> Touch the icon «Calibrate the embroidery hoop».

- The machine recognizes the size of the attached embroidery hoop automatically and moves to the center of the hoop.

- > Center the needle via the arrow icons on the display and confirm.

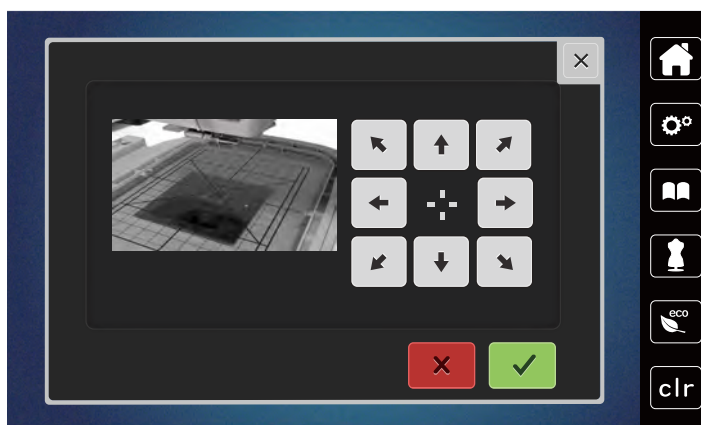

Deactivating securing stitches



- > «»Touch the icon «Setup Program».



- > Touch the icon «Embroidery settings».



- > Touch the icon «Securing stitches on/off».
- > Touch the switch in the lower left corner of the display to deactivate the securing stitches.
 - No securing stitches will be sewn and the bobbin thread needs to be brought up manually and held when embroidering is started.
- > Touch the switch again to activate the securing stitches.

Adjusting the thread cut



- > Touch the icon «Setup Program».



- > Touch the icon «Embroidery settings».



- > Touch the icon «Thread cut settings».



- > To deactivate the automatic thread cut before changing a thread, press the switch in the upper section of the display (1).
- > To activate the automatic thread cut before changing a thread, press the switch in the upper section of the display (1) again.
- > Touch the switch in the lower section of the display (2) to deactivate the automatic thread cut after starting embroidering.
 - The machine won't stop for a manual thread cut.
- > To activate the manual thread cut after embroidering, press the switch in the lower section of the display (2).
 - The machine will stop after about 7 stitches.

- > Cut the remaining thread with scissors.

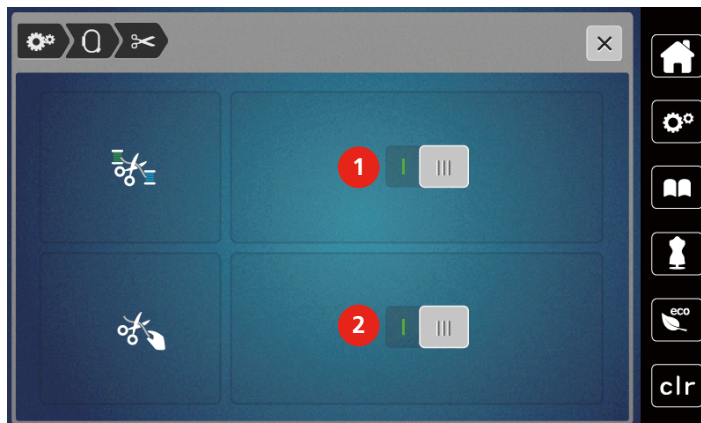

Adjusting the height of the embroidery presser foot



- > Touch the icon «Setup Program».



- > Touch the icon «Embroidery settings».



- > Touch the icon «Adjust the height of the embroidery presser foot».
- > Turn the «Upper Multifunction knob» or the «Lower Multifunction knob» or touch the icons «-» or «+» to adjust the distance between the stitch plate and the presser foot.

3.2 Selecting personal settings



- > Touch the icon «Setup Program».



- > Touch the icon «Personal settings».
- > Select the desired display color.



3.3 Monitoring functions

Activating the upper thread indicator



- > Touch the icon «Setup Program».



- > Touch the icon «Monitoring settings».



- > Touch the switch in the upper portion of the display to deactivate the upper thread indicator.
- > Touch the switch again to activate the upper thread indicator.

Activating the bobbin thread indicator



- > Touch the icon «Setup Program».



- > Touch the icon «Monitoring settings».



- > Touch the switch in the lower section of the display to deactivate the bobbin thread indicator.
- > Touch the switch again to activate the bobbin thread indicator.

3.4 Sound on/off



- > Touch the icon «Setup Program».



- > Touch the icon «Sound on/off» to deactivate any audio signals in general.
- > Touch the icon «Sound on/off» again to deactivate any audio signals in general.

3.5 Machine settings

Adjusting the brightness of the display

The brightness of the display can be adjusted corresponding to the personal preferences.



- > Touch the icon «Setup Program».



- > Touch the icon «Machine settings».



- > Touch the icon «Adjust the brightness».
- > Move the slide in the upper portion of the display using the touchscreen pen/finger or touch the icons «+» or «-» to alter the brightness of the display.

Calibrating the display

Please find further information on this topic in the chapter attachment below troubleshooting at the end of the instruction manual.



> Touch the icon «Setup Program».



> Touch the icon «Machine settings».



> Touch the icon «Calibrate the display».

> Touch the crosses in sequence using the touchscreen pen.

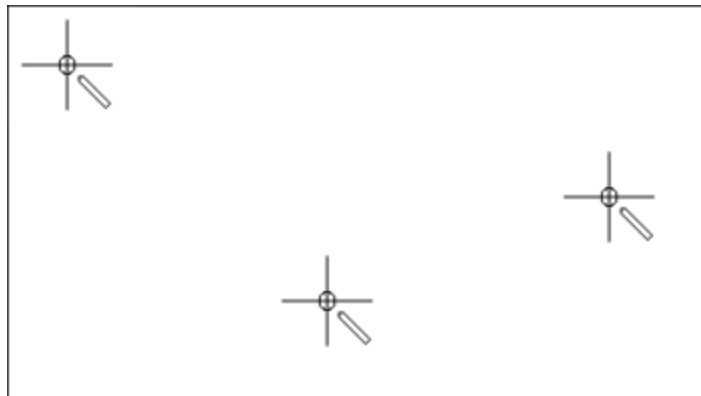

Back to basic setting

ATTENTION: Using this function will delete all individually made settings.



> Touch the icon «Setup Program».



> Touch the icon «Machine settings».



> Touch the icon «Default settings».



> Touch the icon «Default setting embroidery».



> Touch the icon «Confirm» and restart the machine to restore all default settings.

Updating the machine Firmware

The latest firmware of the machine and a detailed step-by-step instruction for updating processes can be downloaded at www.mybernette.com . Personal data and settings are automatically transferred during a firmware update.

NOTICE

USB stick (optional accessory) has been removed too early

Firmware has not been updated and the machine cannot be used.

> Remove the USB stick (Optional accessory) only after the saved data has been transferred successfully.

> Insert the BERNINA USB Stick (optional accessory), FAT32 formatted, providing the latest software into the port.



> Touch the icon «Setup Program».



> Touch the icon «Machine settings».



> Touch the icon «Firmware version».

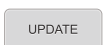

> Touch the icon «Update» to start the update of the firmware.

Checking the firmware version

The firmware version of the machine is displayed.



> Touch the icon «Setup Program».



> Touch the icon «Machine settings».



> Touch the icon «Firmware version».

Reviewing the total number of stitches

The total stitch count of the machine and the number of stitches since the last service performed by a bernette dealer are displayed.



4,000,000 stitches after a service, the symbol indicates that it is recommended to have the machine serviced by a bernette dealer.



> Touch the icon «Setup Program».



> Touch the icon «Machine settings».



> Touch the icon «Firmware version».

Selecting a language

The User Interface can be programmed in different languages according to the customer's wish.



> Touch the icon «Setup Program».



> Touch the icon «Machine settings».



> Touch the icon «Language selection».
> Select a language.

4 System settings

4.1 Calling up the tutorial

The tutorial provides information and explanations on different sections concerning embroidering.



- > Touch the icon «Tutorial».
- > Select the desired topic to get information.

4.2 Using eco mode

During a longer interruption of work the machine can be set into a power save mode. Nothing can be selected in the display and the machine cannot be started.



- > Touch the icon «eco» again.
 - The display goes to sleep. The power consumption is reduced and the sewing light is off.

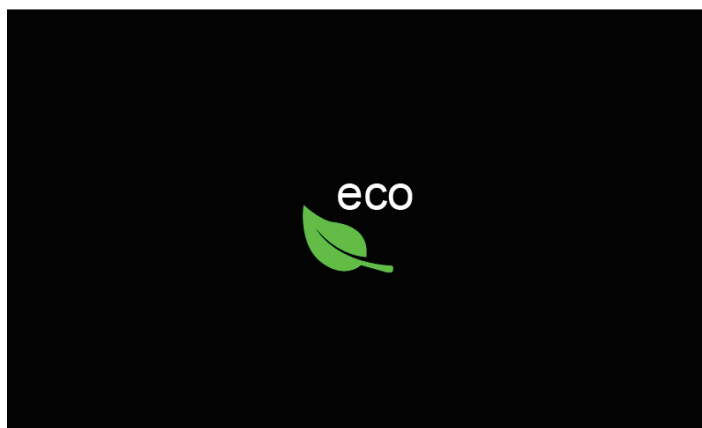

- > Quickly click the green icon «eco» on the screen.
 - The machine is ready for use.

4.3 Cancelling any alterations with «clr»

Any alterations to motifs can be reset to default setting. Exceptions are saved motifs which have been filed in the personal memory and monitoring functions.



- > Touch the icon «clr».

5 Creative embroidering

5.1 Overview embroidering

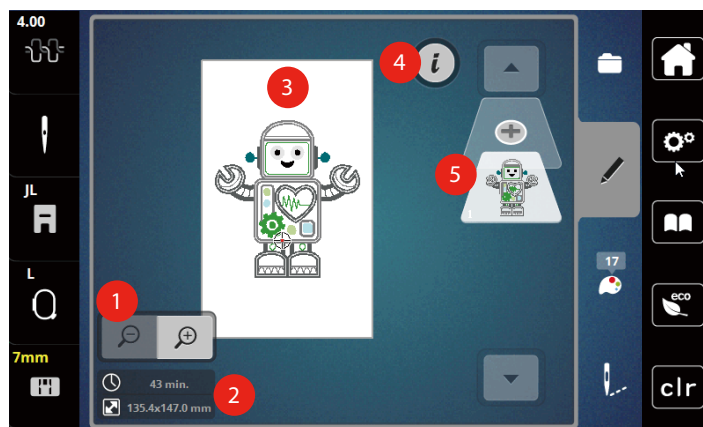

- 1 Scaling up, downsizing and moving the embroidery motif view
- 2 Embroidery time/Embroidery motif size in mm
- 3 Area to be embroidered
- 4 i-Dialog
- 5 Adding an embroidery motif layer

Selecting and changing the embroidery motif



- > Touch the icon «Selection».



- > Touch the icon «Upload embroidery motif».
- > Select a new embroidery motif.

Overview Editing embroidery motif

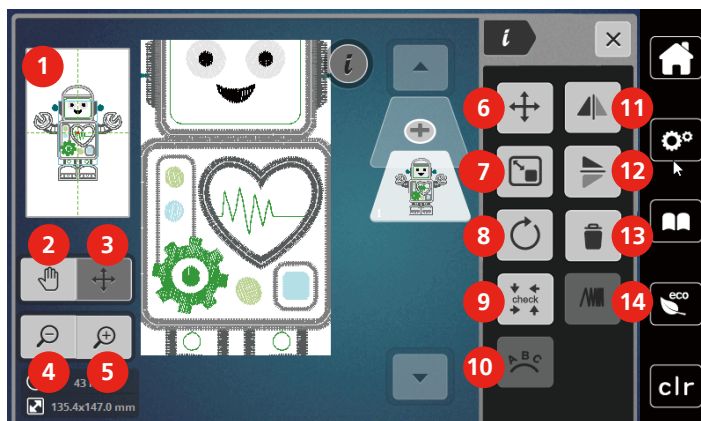

- | | | | |
|---|-----------------------------------|----|-----------------------------|
| 1 | Preview all | 8 | Rotating motif |
| 2 | Moving the view | 9 | Checking motif size |
| 3 | Moving the view of the motif | 10 | Bending the text |
| 4 | Zoom out | 11 | Mirror image left/right |
| 5 | Zoom in | 12 | Mirror image up/down |
| 6 | Moving the embroidery motif | 13 | Deleting |
| 7 | Altering the motif proportionally | 14 | Altering the stitch density |

Moving the embroidery motif

- > Select an embroidery motif.
- > Touch the icon «i»-Dialog.



- > Touch the icon «Move the motif».
- > Turn the Upper Multifunction knob to move the embroidery motif horizontally.
- > Turn the «Lower Multifunction knob» to move the embroidery motif vertically in 0.5-mm steps or touch the «+»/«-» icon or touch the embroidery motif, keep it pressed and move it as you like.
 - The relocation is indicated in the yellow-framed icons.

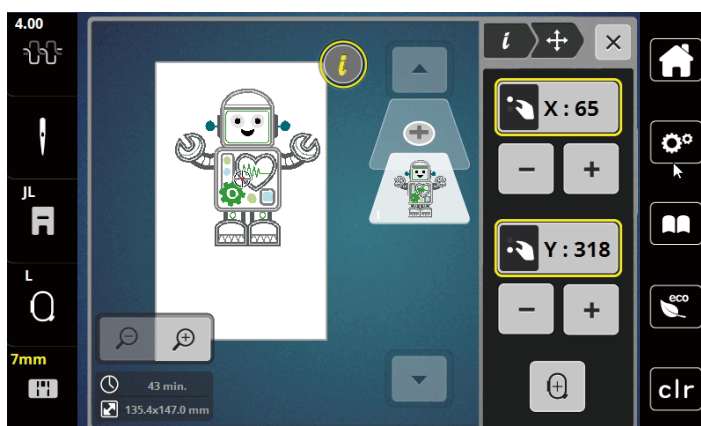

- > Touch the icon «Center of the embroidery motif».
 - The embroidery motif is repositioned in the center of the embroidery hoop.

5.2 Selecting and changing the embroidery motif



- > Touch the icon «Selection».



- > Touch the icon «Upload embroidery motif».
- > Select a new embroidery motif.

5.3 Checking the embroidery time and the embroidery motif size

In the selection menu «Editing» the estimated embroidery time in minutes as well as the width and height of the embroidery motif is indicated at lower left (1).

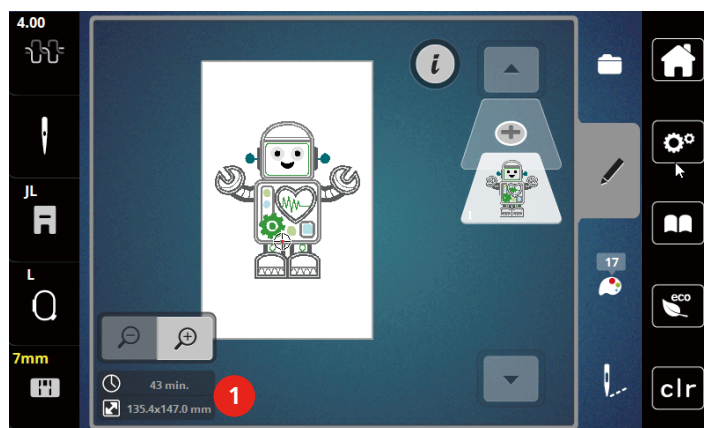

5.4 Regulating the speed

The sewing speed can be adjusted infinitely variable with the slide.

- > Move the slide to the left to reduce the sewing speed.
- > Move the slide to the right to increase the sewing speed.

5.5 Editing the embroidery motif

Overview Editing embroidery motif

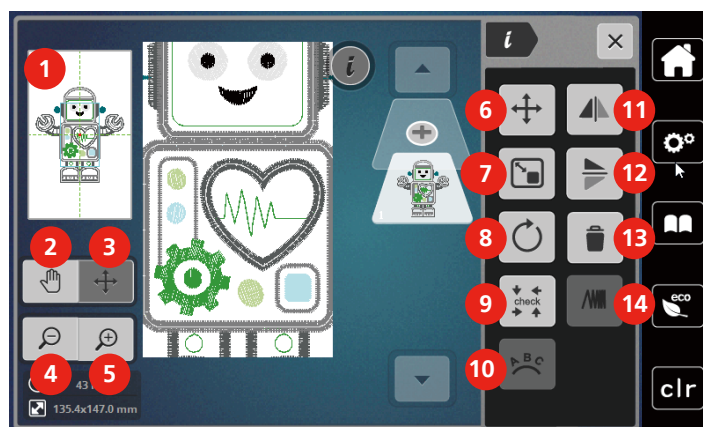

- | | | | |
|---|-----------------------------------|----|-----------------------------|
| 1 | Preview all | 8 | Rotating motif |
| 2 | Moving the view | 9 | Checking motif size |
| 3 | Moving the view of the motif | 10 | Bending the text |
| 4 | Zoom out | 11 | Mirror image left/right |
| 5 | Zoom in | 12 | Mirror image up/down |
| 6 | Moving the embroidery motif | 13 | Deleting |
| 7 | Altering the motif proportionally | 14 | Altering the stitch density |

Scaling up the embroidery motif view

The view of the embroidery motif can be scaled up. In addition to that, the view can be adjusted with or without changing the embroidery position.

- > Select an embroidery motif.
- > Touch the icon «Zoom in» to edit the view of the embroidery motif.



- > Touch the icon «Zoom in» 1 to 9 times to enlarge the view of the embroidery motif gradually.



- > Touch the icon «Zoom out» 1 to 9 times to get back to the Edit Mode.



Downsizing the embroidery motif

The view of the embroidery motif can be downsized. In addition to that, the view can be adjusted with or without changing the embroidery position.

- > Select an embroidery motif.
- > Touch the icon «Zoom in» to scale up the embroidery motif.



- > To downsize the enlarged embroidery motif view by each one step, touch the icon «Zoom out» 1 to 9x.



Moving the embroidery motif view

The view of the embroidery motif can be moved. In addition to that, the embroidery motif position won't be changed.



- > Select an embroidery motif.
- > Touch the icon «Zoom in» to edit the view of the embroidery motif.



- > Touch the icon «Move the view».
 - The icon turns dark gray.
- > Move the view of the embroidery motif using the touchscreen pen/finger.
 - Touch the icon «Zoom out» again to return to previous view. The embroidery position is not altered.



- > To return to the previous view, touch the icon «Zoom out» again .

Moving the embroidery motif in enlarged view

The view of the embroidery motif can be moved when the embroidery position is changed.



- > Select an embroidery motif.
- > To activate the icon «Relocating the motif», touch the icon «Zoom in».



- > Touch the icon «Move the motif».
 - The icon turns dark gray.
- > Move the embroidery motif using the touchscreen pen/finger.
 - The embroidery motif position is altered.



- > To return to the previous view, touch the icon «Zoom out» again .

Moving the embroidery motif



- > Select an embroidery motif.
- > Touch the icon «i»-Dialog.



- > Touch the icon «Move the motif».
- > Turn the Upper Multifunction knob to move the embroidery motif horizontally.
- > Turn the «Lower Multifunction knob» to move the embroidery motif vertically in 0.5-mm steps or touch the «+»/«-» icon or touch the embroidery motif, keep it pressed and move it as you like.
 - The relocation is indicated in the yellow-framed icons.

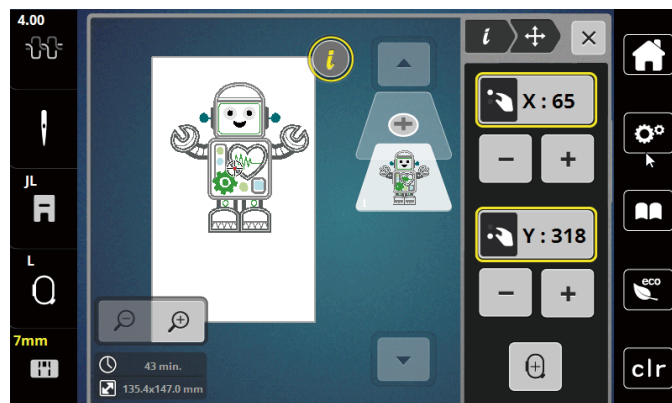



- > Touch the icon «Center of the embroidery motif».
- The embroidery motif is repositioned in the center of the embroidery hoop.

Rotating motif



- > Select an embroidery motif.
- > Touch the icon «i»-Dialog.



- > Touch the icon «Rotate the motif».
- > Turn the «Upper Multifunction knob» or the «Lower Multifunction knob» to the right or touch the «+» icon to rotate the embroidery motif clockwise.
- > Turn the «Upper Multifunction knob» or the «Lower Multifunction knob» to the left or touch the «-» icon to rotate the embroidery motif counter-clockwise.



- > Touch the icon «Rotate the motif +90°» to rotate the embroidery motif in 90°-steps.

Altering the embroidery motif size proportionally

The alteration is limited to +/- 20%.



- > Select an embroidery motif.
- > Touch the icon «i»-Dialog.



- > Touch the icon «Alter the embroidery motif proportionally».
- > To increase the size of the embroidery motif proportionally, turn the «Upper Multifunction knob» or the «Lower Multifunction knob» to the right or touch the icon ««+»».
- > To decrease the size of the embroidery motif proportionally, turn the «Upper Multifunction knob» or the «Lower Multifunction knob» to the left or touch the icon ««-»».

Mirroring embroidery motifs

Embroidery motifs can be mirror-imaged both vertically and horizontally.



- > Select an embroidery motif.
- > Touch the icon «i»-Dialog.



- > Touch the icon «Mirror image left/right» to mirror the embroidery motif vertically.



- > Touch the icon «Mirror image up/down» to mirror the embroidery motif horizontally.

Checking the size and the position of the embroidery motif

It can be checked whether or not the embroidery motif matches the designated position/location on the fabric.

- > Select an embroidery motif.
- > Touch the icon «i»-Dialog.



- > Touch the icon «Checking the size of the embroidery motif».
 - The embroidery hoop travels all the way until the needle is at the position as it is indicated in the display.
 - If the embroidery motif hasn't been positioned correctly yet, the position can be altered via the «Upper/Lower Multifunction knobs» and the complete embroidery positions can be checked again.

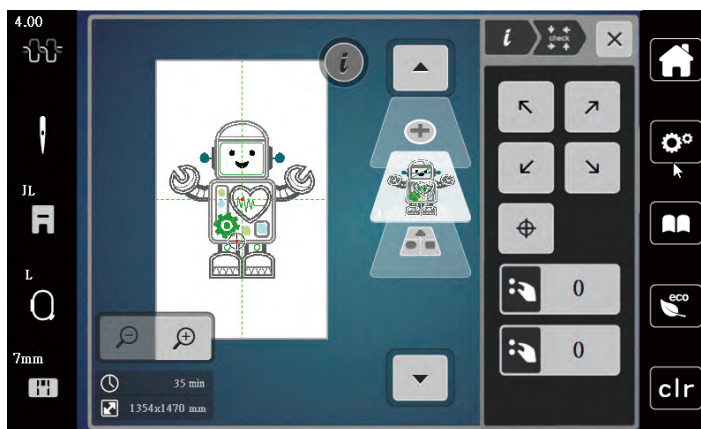

- > Touch the icon «Embroidery motif center» to bring the needle to the center of the embroidery motif.
- > Turn the «Upper Multifunction knob» to move the embroidery motif horizontally.
- > Turn the «Lower Multifunction knob» to move the embroidery motif vertically.

Deleting an embroidery motif

The active embroidery motif is deleted.

- > Select an embroidery motif.
- > Touch the icon «i»-Dialog.



- > Touch the icon «Delete».



- > Touch the icon «Confirm» to delete the embroidery motif.

5.6 Creating lettering

Overview embroidery alphabets

Embroidery motif	Name
ABC	Swiss Block
A B C	Swiss Block vertical
ABC	Childs Play
A B C	Childs Play vertical
ABC	Victoria
ABC	Anniversary
أ ب ت	Arabic
А Б В	Cyrillic
א ב ג	Hebrew

Creating words/sentences

Lettering can be positioned within the hoop as you like. When the embroidery motif is positioned outside the area to be embroidered, the hoop is outlined in red on the display. With the hoop selection it can be checked whether or not the embroidery motif can be embroidered in another hoop. When the lettering does not fit in any hoop, two single words can be combined and positioned below each other as the following example will show.



- > Select the file «Alphabets».
- > Select the font.
- > Enter the text «Made to».
- > Touch the icon (1) (standard setting) to use upper case letters.
- > Touch the icon (2) to use lower case letters.
- > Touch the icon (3) to use numbers and mathematic characters.

- > Touch the icon (4) to use special characters.

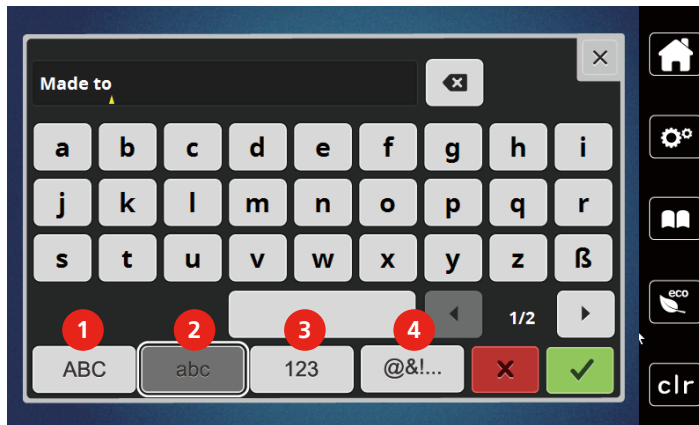

- > Touch the icon «DEL» to delete single letters of the entered text.



- > Touch the icon «Confirm» to accept the text.



- > Touch the icon «Embroidery hoop display/Embroidery hoop selection».
- > Select the hoop.
- > Touch the icon «Embroidery hoop display/Embroidery hoop selection» again to go back to the Edit Mode.

Editing words/sentences



- > Touch the icon «i»-Dialog.



- > Touch the icon «Rotate the motif».



- > Touch the icon «Rotate the motif +90°» to rotate the text by 90°.
- > Touch the icon «i» (1).



- > Touch the icon «Move the motif».
- > Turn the «Upper Multifunction knob» or touch the «+»/«-» icon to move the embroidery motif horizontally.
- > Turn the Lower Multifunction knob or touch the «+»/«-» icon to move the embroidery motif vertically.

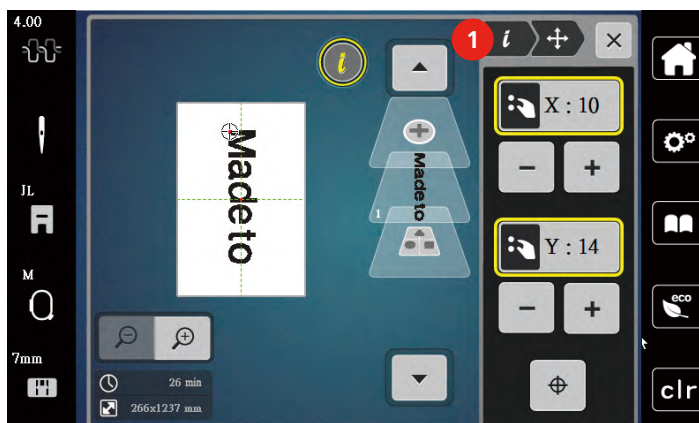



- > Touch the icon «Add motif».
- > Enter and also rotate the text «create».



- > Touch the icon «Embroidery hoop display/Embroidery hoop selection».



- > Touch the icon «Grid on/off» to position the text lines more exactly.

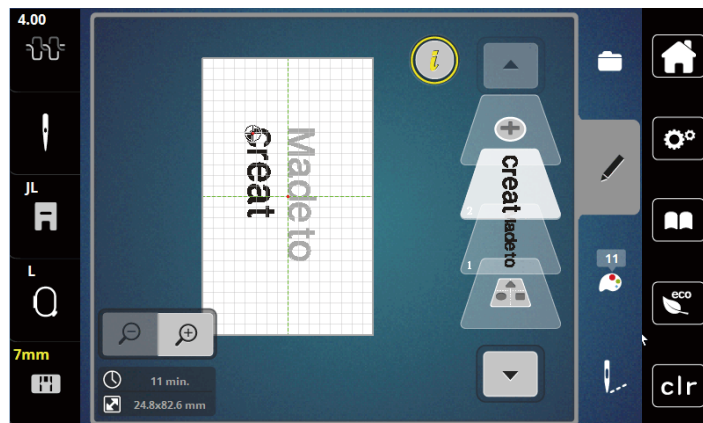

Bending the text

Texts can be arranged and designed arc-shaped. This function is only applicable to alphabets.

- > Select an alphabet embroidery motif.
- > Touch the icon «i»-Dialog.



- > Touch the icon «Bend text».
- > To alter the distance between the characters in millimeter-steps, turn the «Upper Multifunction knob» or touch the icons «+»/«-».
- > To bend the lettering upwards or downwards, turn the «Lower Multifunction knob» to the left or right or touch the icons «+»/«-».

Altering the stitch density

- > Select an embroidery motif. This function is only applicable to alphabets.
- > Select an alphabet embroidery motif.
- > Touch the icon «i»-Dialog.



- > Touch the icon «Altering the stitch density».
- > Touch the percentage icon to adjust the desired stitch density.

5.7 Combining embroidery motifs

Combining embroidery motifs



- > Select an embroidery motif.
- > Touch the icon «Add an embroidery motif» (1).
- > Select another embroidery motif.
- > Touch the icon «Select the combination» (2) to select whole embroidery motifs.
 - The size of the combination cannot be adjusted.

Deleting a single embroidery motif



- > Select the embroidery motif which is to be deleted.
- > Touch the icon «i-Dialog».



- > Touch the icon «Delete».



- > Touch the icon «Confirm».

5.8 Changing the colors of the embroidery motif

Overview changing the color

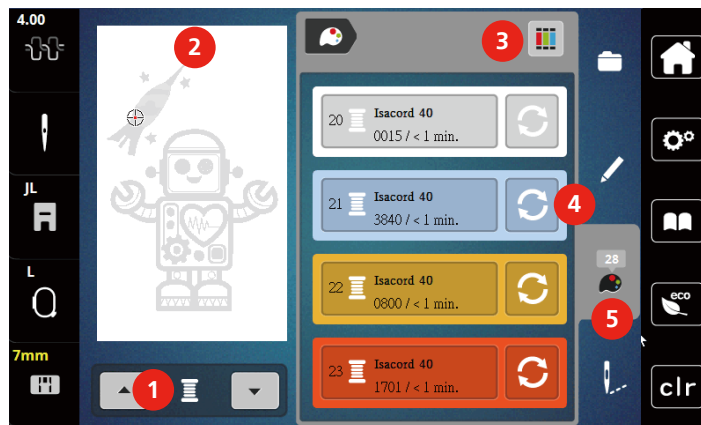

- | | | | |
|---|---------------------------------|---|-------------------|
| 1 | Colors of the embroidery motifs | 4 | Altering color |
| 2 | Preview for selected color | 5 | Color information |
| 3 | Allocating thread brand | | |

Changing the colors



- > Select an embroidery motif.
- > Touch the icon «Color information».



- > Touch the icon «Altering color» next to the color which is to be changed.
- > Changing Colors by searching the theme brand.
 - Touch the icon «Scrolling» (6) in the top right portion of the display to display other thread brands.
- > Touch the icon «Color selection by number» (7) to select the color by entering the color number.
- > Touch the icon «Scrolling» (8) in the lower right portion of the display to display other colors.
- > Select the desired color.

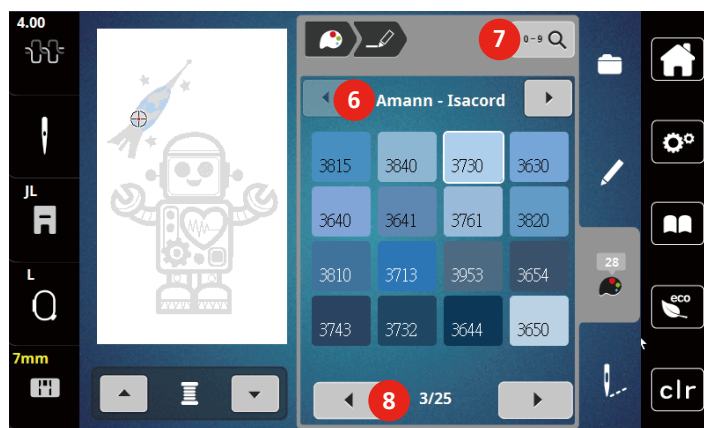

Changing the thread brand



- > Select an embroidery motif.
- > Touch the icon «Color information».



- > Touch the icon «Allocate thread brand».



- > Touch the icon «Scrolling» (1) to have further thread brands displayed.



- > Select a thread brand and touch the icon «Confirm».
- Any thread colors of the selected embroidery motif will be matched with the selected thread brand.

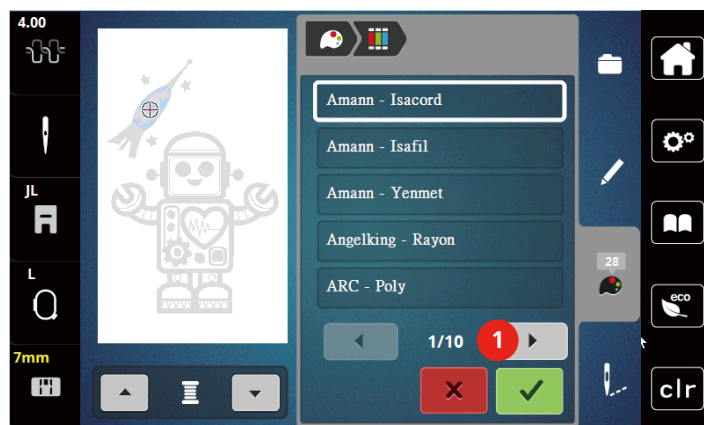

5.9 Embroidering the embroidery motif

Overview Embroidery menu



- | | | | |
|---|-----------------------------|---|---------------------------------------|
| 1 | Basting | 4 | Cutting connecting stitches |
| 2 | Moving the hoop | 5 | Multi-colored embroidery motif on/off |
| 3 | Embroidery sequence control | 6 | Color indication |

Adding basting stitches

The basting stitches can be embroidered along the embroidery motif. As a result, the fabric and the stabilizer are better fixed together.



- > Select an embroidery motif.
- > Touch the icon «Embroidering».



- > Touch the icon «Basting» to embroider the basting stitches along the embroidery motif.
- > Touch the icon «Basting» again to deactivate the basting stitches.

Moving the hoop

If the embroidery project is so big that repeated rehooping is necessary, the embroidered motif can be moved again.



- > Select an embroidery motif.
- > Touch the icon «Embroidering».



- > Touch the icon «Move the hoop».
- > Turn the «Upper Multifunction knob» to move the hoop horizontally.
- > Turn the «Lower Multifunction knob» to move the hoop vertically.

Embroidery sequence control when thread breaks

If the thread breaks, the needle can be repositioned in the embroidery motif using the Embroidery sequence control function.



- > Select an embroidery motif.
- > Touch the icon «Embroidering».



- > Touch the icon «Embroidery sequence control if thread breaks».
 - A compact view of the embroidery motif appears on the left side of the display. On the right side the embroidery motif is shown in enlarged view.

– Repositioning via the compact view

- > Select the desired position in the overall view (1) (2) with the touchscreen pen/finger.

– Repositioning via the stitch bar

- > Select the bar in the display (3) (4) with the touchscreen pen/finger.

– Repositioning via the multifunction knobs

- > To move the embroidery hoop stitch by stitch, turn the «Upper Multifunction knob».
- > To move the embroidery hoop in large steps, turn the «Lower Multifunction knob».

– Repositioning via the magnifier

- > To select the desired stitch via the entry, touch the «Magnifier» (6).

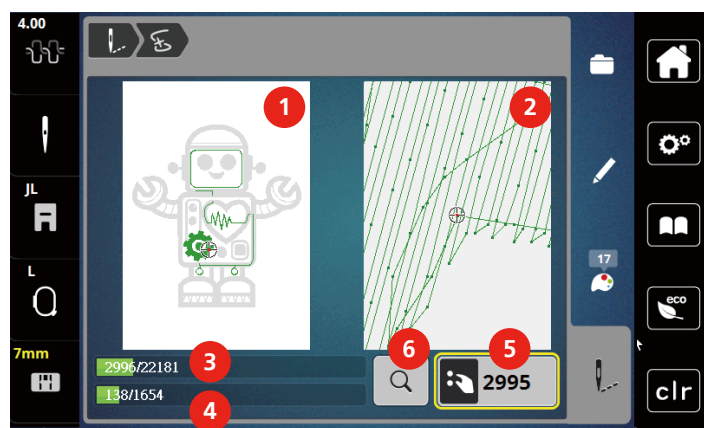

- The number in the yellow-framed icon (5) indicates the number of stitches of the embroidery process

- > Set the needle position back so that the new start is made a few stitches before the thread has broken.

Cutting connecting stitches

The function is activated by default and the connecting stitches are cut automatically. When the function is deactivated, the connecting stitches between the embroidery motifs must be cut manually.



- > Select an embroidery motif.
- > Touch the icon «Embroidering».



- > Touch the yellow-framed icon «Cut the connecting stitches» to deactivate the function.
- > Touch the icon «Cut the connecting stitches» again to activate the function.

Multi-colored embroidery motif on/off

Multi-colored embroidery motifs can also be embroidered in one color.

- > Select an embroidery motif.
- > Touch the icon «Embroidering».



- > Touch the icon «Multi-colored embroidery motif on/off».
 - The embroidery motif is embroidered in one color.

Color indication

Every color of the embroidery motif can be selected individually. The hoop moves to the first stitch of the current color. The currently active color can be embroidered individually or in another sequence.

- > Select an embroidery motif.
- > Touch the icon «Embroidering».



- > Touch the icon «Scroll down» to select the next color of the embroidery motif.



- > Touch the icon «Scroll up» to select the previous color of the embroidery motif.

5.10 Administering embroidery motifs

Administering embroidery motifs

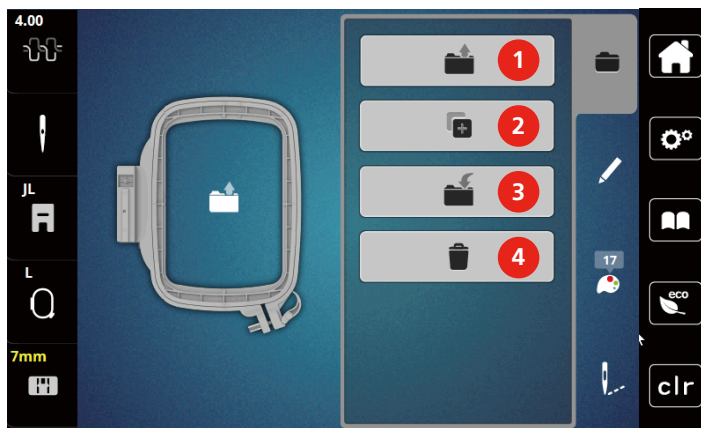

- | | | | |
|---|------------------------------|---|-----------------------------|
| 1 | Loading the embroidery motif | 3 | Saving the embroidery motif |
| 2 | Adding an embroidery motif | 4 | Deleting |

Saving embroidery motifs in the personal memory

In the filing system «Personal memory» any stitch patterns, also those which have been individually edited, can be saved.

- > Select an embroidery motif.
- > Edit the embroidery motif.
- > Touch the icon «Selection».



- > Touch the icon «Save the motif».
 - The embroidery motif to be saved is outlined in yellow.
 - The icon «Embroidery machine» is activated.



- > Touch the icon «Confirm».

Saving the embroidery motif on the USB stick

- > Select an embroidery motif.
- > Edit the embroidery motif.
- > Touch the icon «i»-Dialog.



- > Touch the icon «Save the motif».
 - The embroidery motif to be saved is outlined in yellow.
- > Insert the USB stick into the USB port of the machine.



- > Touch the icon «USB stick».



- > Touch the icon «Confirm».

Overwriting the embroidery motif in the personal memory

- > Select an embroidery motif.
- > Edit the embroidery motif.
- > Touch the icon «Selection».



- > Touch the icon «Save the motif».
 - The embroidery motif to be saved is outlined in yellow.
 - Touch the icon «Embroidery machine» is activated.



- > Select the embroidery motif which is to be overwritten.







- > Touch the icon «Confirm».





Overwriting the embroidery motif in the personal memory

- > Select an embroidery motif.
- > Edit the embroidery motif.
- > Touch the icon «i»-Dialog.







-  > Touch the icon «Save the motif».
 - The embroidery motif to be saved is outlined in yellow.
-  > Insert the USB stick into the USB port of the machine.
-  > Touch the icon «USB stick».
-  > Select the embroidery motif which is to be overwritten.
-  > Touch the icon «Confirm».

Loading an embroidery motif from the personal memory



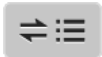

-  > Touch the icon «Selection».
-  > Touch the icon «Upload embroidery motif».
-  > Select the file «Personal embroidery motifs».
-  > Select an embroidery motif.

Loading an embroidery motif from the USB stick







-  > Touch the icon «i»-Dialog.
-  > Insert the USB stick into the USB port of the machine.
-  > Touch the icon «USB stick».
-  > Select a personal embroidery motif.
-  > By clicking on the icon «Display embroidery motif name/embroidery motif image» in the attachment, you can switch between the embroidery motif name and the embroidery motif image. This is only possible when loading a motif from the USB stick.

Deleting an embroidery motif from the personal memory

The embroidery motifs which are saved in the personal memory can be deleted individually.

-  > Touch the icon «i»-Dialog.
-  > Touch the icon «Delete».
-  – Touch the icon «Embroidery machine» is activated.
-  > Select the embroidery motif which is to be deleted.
-  > Touch the icon «Confirm».

Deleting an embroidery motif from the USB stick

-  > Touch the icon «i»-Dialog.
-  > Touch the icon «Delete».
-  > Insert the USB stick into the USB port of the machine.
-  > Touch the icon «USB stick».
-  > Select the embroidery motif which is to be deleted.
-  > Touch the icon «Confirm».

6 Embroidery

6.1 Embroidering via the button «Start/Stop»

In case of a power cut the embroidery process is interrupted. After the restart the machine goes to the position which was embroidered last.



- > Push the button «Start/Stop» to start the embroidery machine.
 - All parts of the motif being in the current color are embroidered.
 - The embroidery machine stops automatically at the end.
 - Both threads are cut automatically.
 - The embroidery machine switches to the next color automatically.



- > Change the upper thread.
- > Push the button «Start/Stop» to embroider the new color.
 - After having completed the embroidery motif, the machine stops automatically and the threads are cut automatically.
- > Touch the icon «Confirm» to finish the embroidery motif.

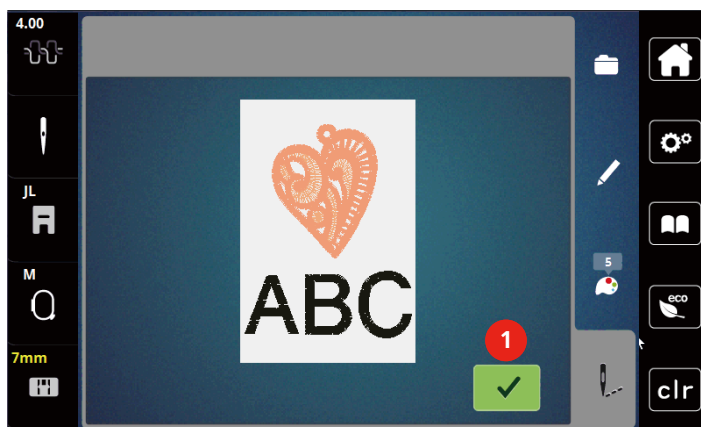

6.2 Increasing the embroidery speed

To ensure the best embroidery quality, the speed when embroidering is reduced depending on the embroidery position. Choose between the two options to either embroider at optimal or maximum speed. Standard = optimal speed. It has to be considered that the quality of the embroidered embroidery motif at maximum speed cannot be ensured.

By switching the machine off and on, the optimal embroidery speed is activated.

Prerequisite:

- The embroidery motif is selected.
- > Touch the icon «Embroidery speed».
 - The maximum speed is activated.
- > Touch the icon «Embroidery speed» again.
 - The optimal speed is activated.



6.3 Adjusting the upper thread tension

Basic settings are applied automatically when an embroidery motif or program is selected.

When using different types of embroidery threads, the optimal tension may vary. Therefore it may be necessary to adjust the upper thread tension according to the embroidery project as well as the desired embroidery motif individually.

The higher the upper thread tension, the tighter the upper thread which means that the bobbin thread is pulled up to the top of the fabric. When the upper thread tension is low, the upper thread is less tightened which means that the bobbin thread is pulled up less.

Alteration of the upper thread tension affect the currently embroidery motif. Permanent alterations of the upper thread tension can be made in the Setup Program.



- > Touch the icon «Upper thread tension».
- > Move the slider in the display using the touchscreen pen/finger to increase or reduce the upper thread tension.

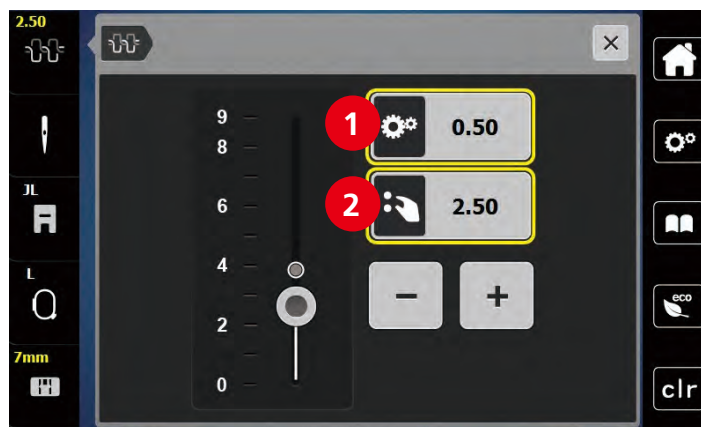

- 1 Permanent alteration of thread tension
- 2 Thread tension of the current embroidery motif

7 BERNINA CutWork Tool

7.1 Changing the CutWork Tool



The CutWork Tool is available optionally. It is not included in the standard delivery of this machine.

The CutWork Tool is a very sharp accessory. Special care is required when working with this tool and keep fingers away from the sharp knife. You can find more information in the CutWork book, which is packaged with the CutWork tool.

In CutWork mode, the upper thread, bobbin thread and thread cut sensor are deactivated.

Prerequisite:

- The stitch plate CutWork/Straight is attached.
- > Remove the presser foot.
- > Remove the needle.
- > Insert the CutWork Tool with the flat side to the back as far up as it will go (1). Tighten the fixing screw (2).

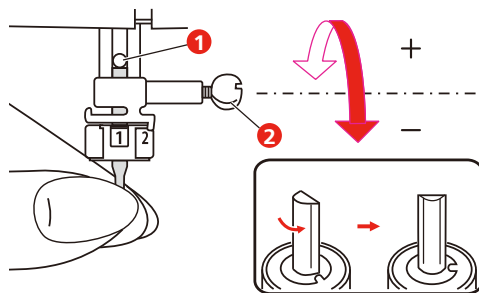

- > Attach the embroidery foot.
- > Select the attached embroidery foot in the embroidery foot selection.

- > Rotate the CutWork tool according to the information on the color display (3).

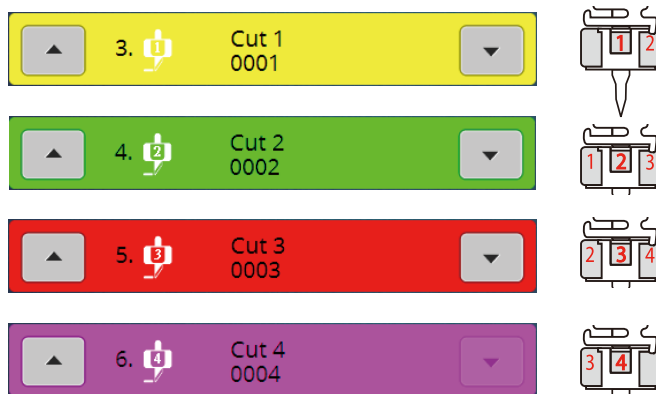

7.2 Start to cut

- > Push the button «Start/Stop» and start to cut.
 - When it is completed, the machine stops automatically and return to Embroidery menu display.
- > Turn the CutWork Tool knife according to the cutting position on the display of Color indication (3).
- > Repeat the same actions.
- > When the cutting is completed, the machine stops automatically and shows the embroidery finished screen on the display.



8 Appendix

8.1 Maintenance and cleaning

Cleaning and maintenance intervals

To ensure the functionality and sewing quality of the machine, the machine must be cleaned and maintained regularly. The intervals for cleaning and maintenance of the machine depend on various factors, such as the fabrics and threads used.

As an advice to clean the machine, a message appears after 500,000 stitches.

As an advice to have the machine maintained, a message appears when 4,000,000 stitches have been sewn after a service.

Cleaning the display

- > Clean the display in the switched off status with a soft slightly damp microfiber cloth.

Cleaning the hook



CAUTION

Electronically driven components

Risk of injury near the needle and the hook.

- > Raise the presser foot.
- > Switch the machine off and disconnect it from the power supply system.

- > Remove the needle and the presser foot.
- > Remove the stitch plate.
- > Clean the bobbin case with a brush.

Please note: The markings of the bobbin case and the stitch plate must be aligned identically.

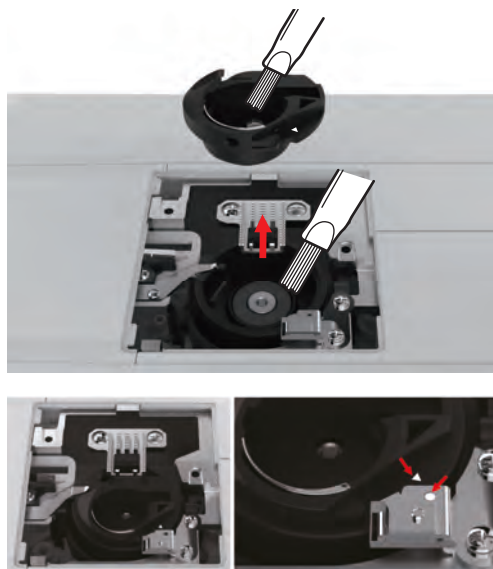

Oiling the needle bar

The needle bar may not move smoothly without lubrication. If the machine is used frequently, the needle bar should be oiled every 6 months to prevent blocking.



Electronically driven components

Risk of injury near the needle bar.

- > Switch off the machine and disconnect it from the power supply.

- > Remove the protective cap (1) and the screw (2).

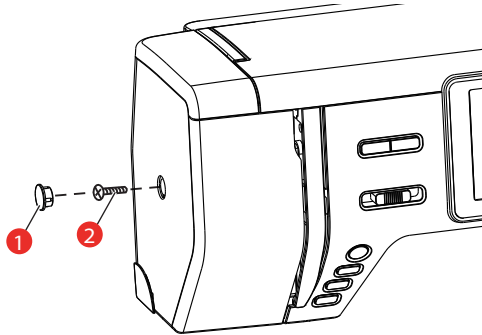

- > Remove headframe cover (3).
 - After removing the headframe cover, pay attention to the moving parts.

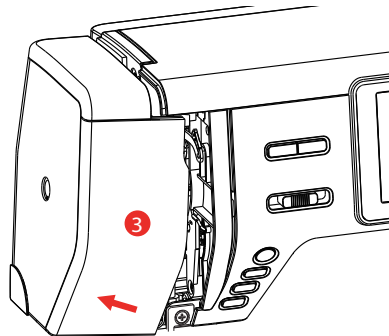

- > Apply a drop of oil to the movement mechanism of the needle bar, including the connecting rod/needle bar, needle bar holder and needle bar holder (apply oil to the points marked with an arrow).

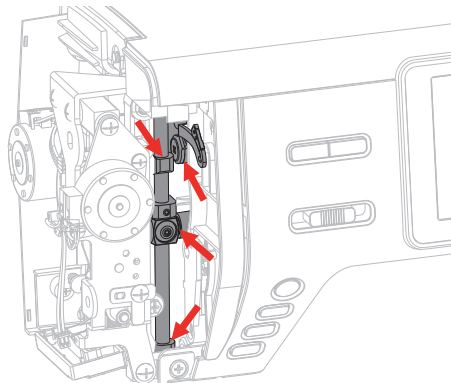

- > Remove the presser foot.
- > Turn the handwheel a few times and remove excess oil with a cloth.
- > Attach the headframe cover again.



8.2 Troubleshooting



Fault	Cause	Repair
Uneven stitch formation	Upper thread too tight or too loose.	> Adjust the upper thread tension.
	Needle blunt or bent.	> Replace the needle, make sure that a new BERNINA quality needle is used.
	Poor quality needle.	> Use a new BERNINA quality needle.
	Poor quality thread.	> Use quality thread.
	Incorrect needle/thread combination.	> Match the needle with the thread size.
	Incorrectly threaded.	> Rethread.
	Dust or thread remnants under the tension spring of the bobbin case.	> Clean the hook.
Skipped stitches	Incorrect needle.	> Use the needle system 130/705H.
	Needle blunt or bent.	> Replace the needle.
	Poor quality needle.	> Use a new BERNINA quality needle.
	The needle is incorrectly inserted.	> Insert the needle with the flat side to the back as far up as it will go into the needle holder and tighten the screw.
	Incorrect needle point.	> Match the needle point to the texture of the material.
Upper thread breaks	Incorrect needle/thread combination.	> Match the needle with the thread size.
	Upper thread is too tight.	> Reduce the upper thread tension.
	Incorrectly threaded.	> Rethread.
	Poor quality thread.	> Use quality thread.
	The stitch plate or the hook tip is damaged.	> Contact a specialized bernette dealer to have the damages repaired. > Replace the stitch plate.



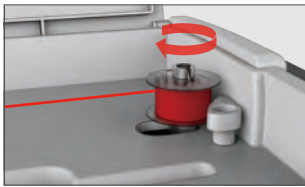
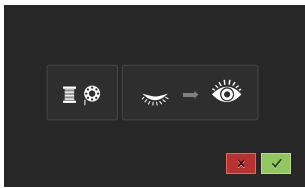

Fault	Cause	Repair
Lower thread breaks	The bobbin is not inserted correctly.	> Remove and reinsert the bobbin and pull on the thread. – The thread should run easily.
	Bobbin is wound incorrectly.	> Check bobbin and thread correctly.
	The stitch hole in the stitch plate damaged.	> Contact a specialized bernette dealer to have the damages repaired. > Replace the stitch plate.
	Needle blunt or bent.	> Replace the needle.
Needle breaks	The needle is incorrectly inserted.	> Insert the needle with the flat side to the back as far up as it will go into the needle holder and tighten the screw.
	Knotted thread.	> Use quality thread.
Display is inactive	Incorrect calibrating data.	> Switch the machine off. > Switch the machine on and at the same time push button «Center embroidery hoop to the needle/Center embroidery motif» and keep it pressed. > Recalibrate the display.
	eco mode activated.	> Touch the icon «eco».
Speed too low	Unfavorable room temperature.	> Place the machine in a warm room one hour before use.
	Settings in the Setup Program.	> Adjust the embroidery speed in the Setup Program. > Adjust the slide.
The machine doesn't start	Unfavorable room temperature.	> Place the machine in a warm room one hour before use. > Connect the machine and switch it on.
	The machine is damaged.	> Contact a specialized bernette dealer.
The light of the button «Start-/Stop» doesn't light up	Light is defect.	> Contact a specialized bernette dealer.
Neither the sewing light nor the light on the free arm lights up	Settings in the Setup Program.	> Activate it in the Setup Program.
	The sewing light is defect.	> Contact a specialized bernette dealer.
Upper thread indicator doesn't react	Settings in the Setup Program.	> Activate it in the Setup Program.
	The upper thread indicator is defect.	> Contact a specialized bernette dealer.
Bobbin thread indicator doesn't react	Settings in the Setup Program.	> Activate it in the Setup Program.
	The bobbin thread indicator is defect.	> Contact a specialized bernette dealer.

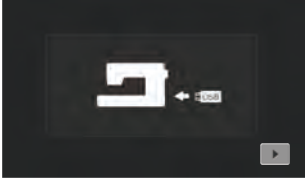
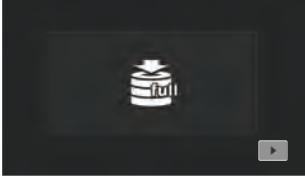
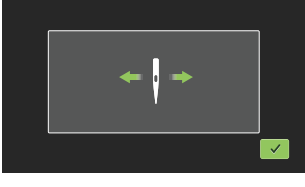
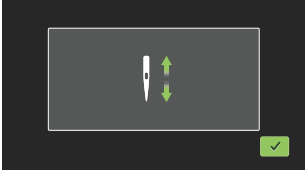

Fault	Cause	Repair
Error during software update	The update process is blocked and the hourglass on the display is inactive.	<ul style="list-style-type: none"> > Remove the USB stick. > Switch the machine off. > Rename the firmware file from «.fw» to «.auto». > Insert the USB stick. > Switch the machine on. <ul style="list-style-type: none"> – The update starts automatically.

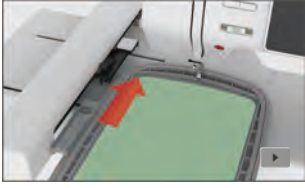
8.3 Error messages

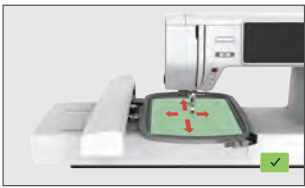
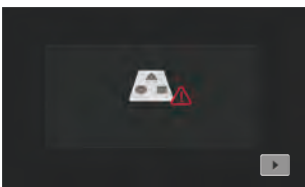
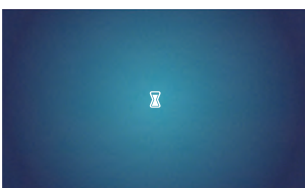
Message on the display	Cause	Repair
	The embroidery module must be removed.	<ul style="list-style-type: none"> > Hold the embroidery module, press the release button and pull the module out.
	The embroidery module must be connected.	<ul style="list-style-type: none"> > Push the embroidery module carefully from left to right into the embroidery module connection of the machine.
	The winding unit is activated.	<ul style="list-style-type: none"> > Deactivate the winding unit.
	The thread indicator is deactivated.	<ul style="list-style-type: none"> > To activate both thread indicators, touch the icon «Confirm». > To keep the thread indicators deactivated, touch the icon «Cancel».
 	The main motor isn't running.	<ul style="list-style-type: none"> > Turn the handwheel clockwise until the needle is at its top position. > Remove the stitch plate. > Remove the thread remnants. > Clean the hook. > Remove the hook and make sure that no broken needle tips stick to the magnetic back of the hook.

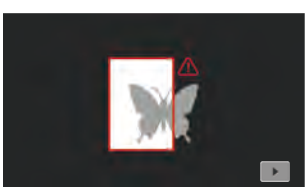
Message on the display	Cause	Repair
	The upper thread is used up.	<ul style="list-style-type: none"> > Insert a new thread spool. > Rethread.
	The upper thread has broken.	<ul style="list-style-type: none"> > Rethread.
	The bobbin thread is used up.	<ul style="list-style-type: none"> > Remove the empty bobbin, wind it again and reinsert it.
	The threader lever is not raised.	<ul style="list-style-type: none"> > Raise the threader lever.
	The USB stick is not connected	<ul style="list-style-type: none"> > Insert the USB stick (optional accessory) into the port.
	Not enough free memory available on the USB stick (optional accessory).	<ul style="list-style-type: none"> > Delete data on the USB stick (optional accessory). > Overwrite data on the USB stick.
	The needle moves sideways.	When the stitch plate is exchanged, this illustration appears because the needle is likely to move.
	The needle moves upwards.	<ul style="list-style-type: none"> > Check whether there are any external objects near the stitch plate. > To raise the needle, touch the icon «Confirm».

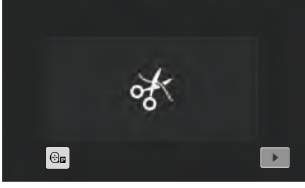
Message on the display	Cause	Repair
	The hoop is not attached.	> Attach the hoop.
	The hoop is attached.	> Remove the embroidery hoop.
	The embroidery hoop is calibrated.	> Touch the icon «Confirm».
	The maximum number of stitches of 120,000 is reached.	> Select another embroidery motif with fewer stitches.
	Files are being loaded.	> Wait for processing process.
	Firmware update failed.	> Check the update file on the USB stick. > Touch the icon «Cancel» and try starting the update again.
	The embroidery motif is partially outside the embroidery hoop and/or is too large for the hoop.	> Reduce the size of the embroidery motif. > Reposition the embroidery motif. > Attach a larger hoop.

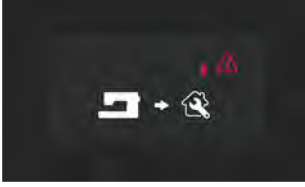
Message on the display	Cause	Repair
	This message appears when the thread cutter is adjusted after embroidery starts.	> Cut the thread manually.
	500,000 stitches have been sewn with the machine since the last cleaning advice.	> Clean the machine. > To be reminded of the cleaning after switching on the machine, touch the icon «Cancel».
	The machine has reached a stitch count of 4,000,000 since the last maintenance by a bernette dealer.	> Contact your specialized bernette dealer to have the machine maintained. > To be reminded of the maintenance after switching on the machine, touch the icon «Cancel».

8.4 Technical data

Designation	Value	Unit
Sewing light (LED)	300, 2	mA, Watt
Maximum speed	Embroidery mode: 850	Stitches per minute
Measures (B x T x H)	509 x 199,8 x 314,3	mm
Weight	10	kg
Energy consumption	100	W
Input voltage	100 – 240	V
Protection class (Electrical engineering)	Protection class II	





9 Overview stitch patterns

9.1 Overview Embroidery motifs









Editing the embroidery motif

















Let your creativity run free. A vast selection of embroidery motifs is at your disposal.













If one of the following pictograms is placed under the embroidery motif number, you will find further information at www.mybernette.com/pictograms.

	Detached point		Appliqué
	Fringe embroidery		CutWork Design (motif)





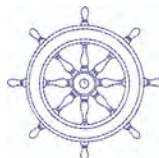









Embellishment

No.	Embroidery motif Colors	Width x Height in mm	No.	Embroidery motif Colors	Width x Height in mm
1 (002_bell)		50,4 103,0	2 (019_swiss)		150,4 129,4
3 (Edelweiss)		102,9 58,5	4 (12383-18)		90,6 171,2
5 (12490-03)		118 113,4	6 (12490-04)		146,4 122,4
7 (12490-05_ sized)		118 97,8	8 (12535-03_ 1_sized)		155 116

No.	Embroidery motif Colors	Width x Height in mm	No.	Embroidery motif Colors	Width x Height in mm
9 (12490-5_sized)		49 100	10 (12587-57)		57,6 20,3
11 (12587-58)		52,8 116,2	12 (12587-59)		33 94,8
13 (12587-60)		126,2 126	14 (12606-33) 		43 70
15 (12611-27) 		136,9 137,3	16 (12611-28) 		140 140
17 (12670-03)		121 144,6	18 (12669-03)		109,4 194,6
19 (19999-002_check_S)		125 136,4	20 (21013-29)		152 40,2
21 (21013-30)		75,8 75,8	22 (21021-04)		123 150,2

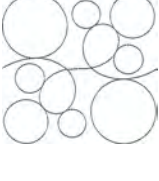





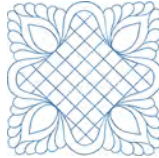







No.	Embroidery motif Colors	Width x Height in mm	No.	Embroidery motif Colors	Width x Height in mm
23 (21021-05)		118,8 155,6	24 (21027-01_ S)		123 122,2
25 (21027-14)		120,8 120,8	26 (32078-02) 		123,4 172,9
27 (BE790308_ bernette) 		155,2 178,2	28 (FB148_48)		101 89,6
29 (FB158_48)		39,6 53,2	30 (NA597)		56,6 52,8
31 (NA614)		102 101,4	32 (NA617)		96,6 96,6
33 (NB843_48)		87,6 121,2			





Quilt motifs

No.	Embroidery motif Colors	Width x Height in mm	No.	Embroidery motif Colors	Width x Height in mm
1 (12380-04)		83 89,8	2 (12380-22)		110,6 60,8
3 (12380-43)		123,6 123,6	4 (12383-09) 		113,0 77,2
5 (12607-20)		122,4 122,4	6 (BD298_L_b ernette)		155 154,6
7 (BD502_48)		61,4 60,8	8 (BD513_48)		63,4 63,4
9 (BD796_48)		47,2 172,7	10 (BD800_48)		126,1 122,3
11 (BD837_48)		123,6 123,6	12 (NB934_48)		132,4 164,8
13 (Quilt 02)		101,8 101,6	14 (Quilt 09)		139,6 139,6







No.	Embroidery motif Colors	Width x Height in mm	No.	Embroidery motif Colors	Width x Height in mm
15 (Quilt 10)		139,6 139,6	16 (Quilt 11)		139,6 139,6

















Borders and Lace

No.	Embroidery motif Colors	Width x Height in mm	No.	Embroidery motif Colors	Width x Height in mm
1 (12398-29) 		26,4 153	2 (12410-08) 		80,6 168,2
3 (12594-03) 		36,4 152	4 (12659-01) 		45,2 57,8
5 (BC015105)		118,4 123	6 (BC01506)		103 131,8
7 (BD567_48)		108 108,2	8 (BE790504)		121,4 121,4
9 (BE790702)		73 190,5	10 (BE790704)		72,5 217,7















No.	Embroidery motif Colors	Width x Height in mm	No.	Embroidery motif Colors	Width x Height in mm
11 (BE790705)		42,3 169,3	12 (FQ736_48)		7,9 253,2
13 (NY)		67 151,6	14 (NX952)		65,6 98,6
15 (NX238)		71,1 97,9			













Children

No.	Embroidery motif Colors	Width x Height in mm	No.	Embroidery motif Colors	Width x Height in mm
1 (12401-17)		98,8 55,2	2 (12590-03) 		135,5 147
3 (BE790306)		132,2 151,4	4 (BE790307) 		141,5 126,9

No.	Embroidery motif Colors	Width x Height in mm	No.	Embroidery motif Colors	Width x Height in mm
5 (BE790313) 		99 102,4	6 (CM193_48) 		106,6 127,4
7 (CM368_48)		70,2 140	8 (CM376_48) 		100,4 97,6
9 (NA667)		83,8 83,8	10 (NB302-48)		68,2 80,6
11 (CK229)		88,8 98	12 (CM428_48) 		78,2 106,4
13 (MS974)		94,2 98,6	14 (NZ612)		96 99,6
15 (NZ613)		103 84,1	16 (NZ611)		99,6 81,2











Flowers

















No.	Embroidery motif Colors	Width x Height in mm	No.	Embroidery motif Colors	Width x Height in mm
1 (12392-01) 		112,6 157,4	2 (12392-13)		112,6 203,4
3 (21008-24)		97,6 121,6	4 (BE790406)		120,0 180,8
5 (21012-04) 		123,2 124	6 (80001-23)		85 101,6
7 (BE790304_ sized)		115,2 59,6	8 (BE790401_ bernette)		155,1 220,9
9 (BE790402_ sized)		135,6 259	10 (BE790404_ bernette)		157 180,2
11 (F1135)		88,6 87,1	12 (F1136)		84,7 89,2

No.	Embroidery motif Colors	Width x Height in mm	No.	Embroidery motif Colors	Width x Height in mm
13 (FQ527_48)		90,4 141,4	14 (FQ562_48)		90,4 156,4
15 (FQ808_48)		123,8 142,4	16 (FQ810_48)		23,6 206,4
17 (NA146)		63,2 69,3	18 (NB039_48)		97 127
19 (Rose_S)		63,9 129,2	20 (Sunflower)		91 88,2
21 (FP005)		80,8 95,2	22 (FM856)		76,2 68,2
23 (FQ681_48)		107 138,8	24 (FP238_S)		61,2 65,4

No.	Embroidery motif Colors	Width x Height in mm	No.	Embroidery motif Colors	Width x Height in mm
25 (FQ239_48)		62,6 90,4			





Seasons

No.	Embroidery motif Colors	Width x Height in mm	No.	Embroidery motif Colors	Width x Height in mm
1 (12384-02)		132,8 203,4	2 (12384-11)		84,4 189,8
3 (12400-03)		123,4 161,3	4 (12400-11)		74,2 211,9
5 (12427-01)		133,8 167,6	6 (12427-11)		81,6 126,2
7 (12443-03)		120,4 161,4	8 (12443-11)		73,4 193,1
9 (BE790301_ sized)		116,2 81,4	10 (BE790303)		69,6 70,2







No.	Embroidery motif Colors	Width x Height in mm	No.	Embroidery motif Colors	Width x Height in mm
11 (NA006)		72,4 91,8	12 (HG747_48) 		124 147,4
13 (12421-03)		45,8 48,4	14 (12421-11)		39,9 43,6
15 (12421-37)		67,4 61	16 (FQ749_48)		77,6 94,8
17 (HE252) 		88,1 144,9	18 (HE255) 		133,2 127,2
19 (HE563)		63,2 129,4	20 (HE919_48)		89,2 69,2
21 (HG053_48)		122 121,8	22 (HG795_48)		89,2 164,4
23 (HD382)		66 97,4	24 (HD246)		80,8 99





















No.	Embroidery motif Colors	Width x Height in mm	No.	Embroidery motif Colors	Width x Height in mm
25 (HE179)		89 95,2			















Asia

No.	Embroidery motif Colors	Width x Height in mm	No.	Embroidery motif Colors	Width x Height in mm
1 (FB276_48_ sized)		115,1 103,2	2 (FB283_48)		102,4 109,4
3 (FQ194_48)		120,2 118,4	4 (NB124_48 _sized 100%)		155 118,6

















Sport/Hobby















No.	Embroidery motif Colors	Width x Height in mm	No.	Embroidery motif Colors	Width x Height in mm
1 (12465-33)		80 79,8	2 (NX688)		92,2 85,6
3 (12611-08) 		80 119,7	4 (12611-21) 		71,7 155,8







No.	Embroidery motif Colors	Width x Height in mm	No.	Embroidery motif Colors	Width x Height in mm
5 (12611-22) 		71,7 155,8	6 (12611-23) 		71,7 155,8
7 (12677-01_ sized) 		117,2 115,2	8 (12677-02) 		116,4 115
9 (12677-03_ sized) 		117 82,4	10 (80085-25) 		134,8 166,2
11 (BE790601_ S)		80,3 80,2	12 (BE790602)		80,2 75,6
13 (BE790603)		80,4 74,8	14 (BE790604)		79,8 80,4
15 (BE790604)		79,6 79,6	16 (BE790606_ S)		100,2 86
17 (BE790607)		79,8 74,4	18 (BE790608)		80,4 80

No.	Embroidery motif Colors	Width x Height in mm	No.	Embroidery motif Colors	Width x Height in mm
19 (SP980)		63,3 63,6	20 (SP989)		101,6 82,4
21 (CK510)		76,2 60	22 (CK522)		70,8 53,2
23 (CK970)		84,8 81,6	24 (LT749)		99,2 38,4
25 (LT920)		89,1 55,6	26 (CM442_48)		46,4 47
27 (LT870)		97,6 57	28 (NB759)		98,8 61,6
29 (RC675_S)		101,6 79,6	30 (RC765_48)		100,4 99
31 (SR067)		87,6 96,8	32 (SR589)		95,2 66,6











Animals

No.	Embroidery motif Colors	Width x Height in mm	No.	Embroidery motif Colors	Width x Height in mm
1 (BE790302)		68,4 66,4	2 (12672-02)		138 133,4
3 (CM022_4 8)		89,2 97	4 (CM142_4 8)		56,6 66,8
5 (CM211_4 8)		80,6 70,6	6 (CM213_4 8)		58,2 102
7 (CM220_4 8) 		71,4 71,8	8 (CM226_4 8) 		63,2 63
9 (CM286_4 8)		97,8 82,4	10 (CM362_4 8_sized) 		115,1 107,8
11 (CM384_4 8)		77,4 80,6	12 (CM465_4 8_sized)		48,2 33
13 (DEC104)		10,4 13	14 (FQ617_48)		118 198,2



No.	Embroidery motif Colors	Width x Height in mm	No.	Embroidery motif Colors	Width x Height in mm
15 (FQ624_48)		64,5 144,2	16 (FQ945_48 _S)		93,8 95
17 (LJ699)		93,2 98	18 (WM785)		84,6 103,4
19 (WP201_4 8)		76,2 92	20 (WP325_4 8)		77,8 94
21 (WP217_4 8)		93,8 78,2	22 (WP224_4 8)		100,4 111
23 (WP415_4 8)		132,4 148,4	24 (WP421_4 8)		95,8 137,6
25 (WS610_4 8_sized)		120 104,4	26 (CM442H D26748)		65,2 51,4
27 (WM784)		106 114,4	28 (BE790305) 		118,2 145,6

No.	Embroidery motif Colors	Width x Height in mm	No.	Embroidery motif Colors	Width x Height in mm
29 (BE790309) 		87,5 149,8	30 (BE790311) 		114,1 152,5
31 (BE790312) 		122 133			

Cutwork

No.	Embroidery motif Colors	Width x Height in mm	No.	Embroidery motif Colors	Width x Height in mm
1 (CM594_4 8) 		96 75,6	2 (CM594_4 8_CWA01) 		90,8 110,0
3 (CM594_4 8_CWA02) 		43,6 50,2	4 (FS344_48)		94,4 101
5 (FS345_48)		92,6 104,9	6 (FS345_48 _CWA) 		80,6 72,2

Campaign

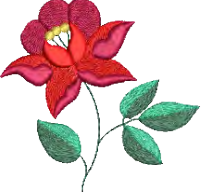
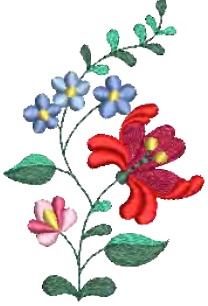
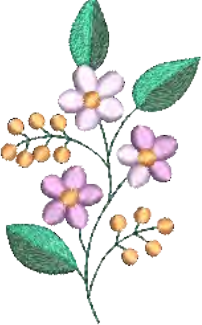
No.	Embroidery motif Colors	Width x Height in mm	No.	Embroidery motif Colors	Width x Height in mm
1 (Campaign _3_elen- ts)		118,9 216,7	2 (Campaign _1_elen- t)		75,3 69,3
3 (FB060)		75,7 72,9	4 (FB062)		60 91
5 (FB069)		53,1 87,4			

Index

A

Activating the bobbin thread indicator	45
Activating the upper thread indicator.....	45
Adjusting the brightness of the display.....	45
Altering the stitch density	59
Attaching the hoop.....	39

B

Back to default settings.....	46
-------------------------------	----

C

Calibrating the display	46
Calibrating the hoop.....	42
Calling up the tutorial.....	49
Checking the firmware version.....	47
Cleaning the hook	71
Combining embroidery motifs.....	60
Connecting the embroidery module.....	25

D

Deactivating securing stitches	43
--------------------------------------	----

E

Embroidery module.....	12
Embroidery test.....	20
Environmental Protection.....	6
Error messages.....	75
Explanation of symbols	7

F

Fitting the embroidery needle	27
-------------------------------------	----

I

Inserting thread spool	24
------------------------------	----

M

Maintenance and cleaning	71
--------------------------------	----

N

Needle, Thread, Fabric	17
Needle/thread combination.....	18

O

Overview of embroidery motifs	79
-------------------------------------	----

P

Positioning the spool disc.....	23
---------------------------------	----

R

Regulating the speed	52
----------------------------	----

S

Safety Instructions.....	4
Selecting a language.....	48
Selecting an embroidery motif	35
Setting the display color.....	44
Sound on/off	45

T

Technical data.....	78
Threading preparation	28
Threading the bobbin thread	33
Threading the upper thread	28
Troubleshooting.....	73

U

Updating the machine Firmware	47
Using a spool net	23
Using eco mode.....	49

W

Winding the bobbin thread.....	31
--------------------------------	----



www.mybernette.com/b70DECO

© BERNINA International AG
Steckborn CH, www.bernina.com