



BERNINA 790 PLUS

LOOKING FOR A NEW SEWING PROJECT?

You can find what you want in "inspiration", our sewing magazine. Thanks to great sewing patterns and detailed sewing instructions, every project succeeds right away.

Inspiration magazine
is available in German, English,
French and Dutch



* Not available in all countries.

Edition notice

Graphics

www.sculpt.ch

Text, Setting and Layout

BERNINA International AG

Photos

Patrice Heilmann, Winterthur

Order number

0359645.20A.04

2018-11 EN

Copyright

2018 BERNINA International AG

All rights reserved: For technical reasons and for the purpose of product improvements, changes concerning the features of the machine can be made at any time and without advance notice. The supplied accessory can vary depending on the country of delivery.



Table of Contents

IMPORTANT SAFETY INSTRUCTIONS	16
Important information	18
1 My BERNINA	19
1.1 Introduction.....	19
1.2 BERNINA Quality control.....	19
1.3 Welcome to the world of BERNINA.....	19
1.4 Explanation of symbols.....	20
1.5 Overview Machine.....	21
Overview front controls.....	21
Overview front.....	22
Overview sideways.....	23
Overview back.....	24
1.6 Supplied accessories.....	24
Overview accessories machine.....	24
Use of the power cable (only USA/Canada).....	27
Overview presser feet.....	27
Accessory box.....	29
1.7 Overview User Interface.....	30
Overview functions/visual information.....	30
Overview System settings.....	30
Overview selection menu sewing.....	31
Overview Icons.....	31
1.8 Needle, Thread, Fabric.....	32
Overview Needles.....	32
Example for needle description.....	34
Thread selection.....	34
Needle/thread combination.....	35
2 Sewing preparation	36
2.1 Accessory box.....	36
Accessory box free standing.....	36
Storing accessory.....	36
2.2 Connection and Switching on.....	37
Connecting the foot control.....	37
Connecting the machine.....	37
Attaching the knee lifter of the Free Hand System.....	38
Fixing the touchscreen pen.....	38
Switching the machine on.....	38
2.3 Foot control.....	39
Regulating the speed via the foot control.....	39
Raising/Lowering the needle.....	39
Programming the foot control individually.....	39
2.4 Spool pin.....	40
Swiveling spool pin.....	40
Horizontal spool pin.....	40



2.5	Free arm	41
2.6	Feed dog.....	42
	Adjusting the feed dog	42
2.7	Slide-on table.....	43
	Using the slide-on table	43
	Attaching the seam guide.....	43
2.8	Presser foot.....	44
	Adjusting the presser foot position via the knee lifter of the Free Hand System	44
	Adjusting the presser foot position via the button «Presser foot up/down»	44
	Changing the presser foot	44
	Selecting the presser foot in the user interface.....	44
	Adjusting the presser foot pressure.....	45
2.9	Instruction for adjusting the feed dog	45
2.10	Needle and stitch plate.....	46
	Changing the needle	46
	Selecting the needle in the User Interface	46
	Selecting needle type and needle size	46
	Adjusting the needle position up/down	47
	Adjusting the needle position left/right	47
	Needle stop up/down (permanent)	47
	Changing the stitch plate	48
	Selecting the stitch plate in the User Interface.....	48
2.11	Threading	49
	Threading the upper thread	49
	Threading the double needle.....	51
	Threading the triple needle.....	52
	Winding the bobbin thread	53
	Threading the bobbin thread.....	54
	Indicating fill level of bobbin thread.....	56
3	Setup Program	57
3.1	Sewing settings.....	57
	Adjusting the upper thread tension	57
	Adjusting the maximum sewing speed.....	57
	Programming the securing stitches	57
	Adjusting the hovering height of the presser foot.....	57
	Programming the button «Pattern end»	58
	Programming the button «Thread cutter»	59
	Adjusting the presser foot position with needle stop down.....	59
	Programming the button «Quick reverse»	60
	Programming the button «Securing»	60
	Programming the foot control	61



5.3	Regulating the speed	80
5.4	Adjusting the upper thread tension	80
5.5	Editing stitch patterns	81
	Changing the stitch width	81
	Changing the stitch length	81
	Correcting the balance	82
	Programming pattern repeat	82
	Programming long stitch	82
	Mirror image of stitch patterns	83
	Editing stitch pattern length	83
	Programming the stitch counter function.....	83
	Quick reverse.....	84
	Permanent Quick reverse	84
	Backstepping.....	84
	Changing the sewing direction	84
5.6	Combining stitch patterns	85
	Overview Combi mode	85
	Overview Combi mode extended.....	85
	Creating Stitch pattern combinations.....	86
	Saving a stitch pattern combination	86
	Loading a stitch pattern combination.....	86
	Overwriting a stitch pattern combination.....	86
	Deleting a stitch pattern combination	87
	Editing the view of the stitch pattern combination.....	87
	Editing a single stitch pattern.....	87
	Deleting a single stitch pattern	88
	Relocating a single stitch pattern	88
	Adding a single stitch pattern	89
	Aligning the stitch length and width.....	89
	Mirroring a stitch pattern combination	90
	Stitch pattern combination Subdivider 1	90
	Stitch pattern combination Subdivider 2	91
	Securing a stitch pattern combination.....	91
	Relocating several stitch patterns.....	91
	Programming pattern repeat	92
	Changing the sewing direction of a stitch pattern.....	92
	Changing the sewing direction of a stitch pattern combination	92
5.7	Administering stitch patterns.....	92
	Saving settings of stitch patterns	92
	Calling up the previously sewn stitch patterns.....	93
	Saving stitch patterns in personal memory	93
	Overwriting stitch patterns from the personal memory	93
	Loading stitch patterns from the personal memory	93
	Deleting stitch patterns from the personal memory.....	94
	Saving stitch patterns on the BERNINA USB stick.....	94
	Uploading a stitch pattern from the BERNINA USB stick	94
	Deleting stitch patterns from the BERNINA USB stick	95



5.8	Stitch Designer.....	95
	Overview Stitch Designer.....	95
	Creating your own stitch pattern.....	96
	Editing the view.....	96
	Inserting points.....	97
	Relocating the points.....	97
	Duplicating points.....	97
	Deleting points.....	98
	Activating the triple stitch.....	98
	Mirror image of stitch patterns.....	99
	Reversing the stitch sequence.....	99
	Designing a stitch pattern from scratch.....	99
	Determining the stitch pattern width.....	100
5.9	Securing.....	100
	Securing a seam with the button «Securing».....	100
	Securing with the button «Pattern end».....	100
5.10	Height Compensation of uneven layers.....	100
5.11	Sewing Corners.....	101
6	Practical stitches.....	102
6.1	Overview Practical stitches.....	102
6.2	Sewing straight stitch.....	104
6.3	Securing with the automatic Securing Program.....	105
6.4	Sewing in the zipper.....	105
6.5	Sewing both sides of the zipper from bottom to top.....	106
6.6	Sewing Triple straight stitch.....	107
6.7	Sewing Triple zig zag.....	108
6.8	Manual darning.....	108
6.9	Automatic darning.....	110
6.10	Reinforced darning, automatic.....	111
6.11	Reinforced Darning Program.....	112
6.12	Finishing edges.....	112
6.13	Sewing Double overlock.....	113
6.14	Narrow edgestitching.....	113
6.15	Wide edgestitching.....	114
6.16	Edgestitching using the seam guide.....	114
6.17	Sewing hem edges.....	114
6.18	Sewing blind hems.....	115
6.19	Sewing visible hems.....	116
6.20	Sewing flat joining seams.....	117
6.21	Sewing basting stitches.....	117
7	Decorative stitches.....	118
7.1	Overview Decorative Stitches.....	118
7.2	Bobbin-Play.....	119



7.3	Altering the stitch density.....	120
7.4	Tapering	121
	Overview Tapering.....	121
	Altering points of a stitch pattern	121
	Sewing tapering	122
	Sewing tapering automatically.....	123
7.5	Sewing cross stitches.....	123
7.6	Pintucks	124
	Pintucks.....	124
	Overview pintucks	124
	Inserting the cord	125
	Sewing Pintucks	125
8	Alphabets and Monograms	126
8.1	Overview Alphabets	126
8.2	Creating lettering.....	127
8.3	Altering font size.....	127
8.4	Altering size of monogram.....	128
9	Buttonholes.....	129
9.1	Overview Buttonholes	129
9.2	Making use of the height compensation tool	130
9.3	Using the compensation plate	131
9.4	Marking buttonholes.....	131
9.5	Cord	132
	Using cord with the Buttonhole foot with slide No. 3A	132
	Using cord with the Buttonhole foot No. 3C (optional accessory).....	133
9.6	Sewing a test sample	134
9.7	Determining the buttonhole slit width	134
9.8	Determining the buttonhole length	135
9.9	Determining the buttonhole length with Buttonhole foot No. 3C (optional accessory)	135
9.10	Sewing a buttonhole automatically	136
9.11	Programming the Heirloom buttonhole	137
9.12	Sewing the manual 7-step buttonhole.....	137
9.13	Sewing the manual 5-step buttonhole.....	138
9.14	Cutting the buttonhole open with the seam ripper.....	139
9.15	Cutting open buttonholes with the buttonhole cutter (optional accessory)	139
9.16	Sewing on buttons.....	139
9.17	Sewing eyelets	140
10	Quilting	141
10.1	Overview Quilt Stitches	141
10.2	Quilting, Securing Program	142
10.3	Sewing handlook quilt stitches.....	142



13.4	Needle and stitch plate.....	158
	Inserting the embroidery needle	158
	Selecting the embroidery needle in the User Interface.....	159
	Selecting needle type and needle size	159
	Attaching the stitch plate	160
	Selecting the stitch plate in the User Interface.....	160
	Thread-up command.....	161
13.5	Embroidery hoop	161
	Overview embroidery hoop selection	161
	Selecting the embroidery hoop	161
	Tear-away stabilizers.....	162
	Cut-away stabilizers.....	162
	Using adhesive spray	162
	Using spray starch	162
	Using iron-on interfacing	162
	Using paper-backed adhesive stabilizer	162
	Using water-soluble stabilizer	163
	Preparing the embroidery hoop	163
	Attaching the hoop	164
	Overview Embroidery functions	165
	Center the needle to the embroidery hoop	165
	Moving the hoop to the back	165
	Moving the module for the sewing mode	165
	Grid on/off	166
	Locating the center of the embroidery motif.....	166
	Virtual positioning of the embroidery hoop.....	166
14	Setup Program	167
14.1	Adjusting the embroidery settings in the Setup Program	167
15	Creative embroidering	168
15.1	Overview embroidering	168
15.2	Selecting and changing the embroidery motif	168
15.3	Checking the embroidery time and the embroidery motif size	168
15.4	Regulating the speed	168



15.5	Editing the embroidery motif.....	169
	Overview Editing embroidery motif.....	169
	Scaling up the embroidery motif view.....	169
	Downsizing the embroidery motif view.....	169
	Moving the embroidery motif view.....	170
	Moving the embroidery motif in enlarged view.....	170
	Moving the embroidery motif.....	170
	Rotating motif.....	171
	Altering the embroidery motif size proportionally.....	171
	Altering the embroidery motif size disproportionately.....	171
	Mirroring embroidery motifs.....	172
	Bending the text.....	172
	Changing the stitch type.....	173
	Altering the stitch density.....	173
	Checking the size and the position of the embroidery motif.....	173
	Endless embroidery.....	174
	Duplicating the embroidery motif.....	176
	Deleting an embroidery motif.....	176
	Changing the sequence within an embroidery motif combination.....	176
	Undoing entries.....	177
	Grouping embroidery motifs.....	177
15.6	Pinpoint placement.....	178
	Positioning of grid points.....	178
	Free point positioning.....	179
15.7	Combining embroidery motifs.....	180
	Combining embroidery motifs.....	180
	Deleting a single embroidery motif.....	180
	Duplicating the embroidery motif.....	181
	Duplicating a combination.....	181
15.8	Creating lettering.....	182
	Overview embroidery alphabets.....	182
	Creating words/sentences.....	183
	Editing words/sentences.....	184
15.9	Changing the colors of the embroidery motif.....	185
	Overview changing the color.....	185
	Changing the colors.....	185
	Altering the colors via the color wheel.....	186
	Changing the thread brand.....	186
15.10	Embroidering the embroidery motif.....	187
	Overview Embroidery menu.....	187
	Adding basting stitches.....	187
	Moving the hoop.....	188
	Embroidery sequence control when thread breaks.....	188
	Cutting connecting stitches.....	188
	Reducing color changes.....	188
	Multi-colored embroidery motif on/off.....	189
	Endless Embroidery.....	189
	Color indication.....	190
15.11	Free arm embroidering.....	190



15.12	Administering embroidery motifs	191
	Administering embroidery motifs.....	191
	Saving embroidery motifs in the personal memory.....	191
	Saving the embroidery motif on the BERNINA USB stick.....	192
	Overwriting the embroidery motif in the personal memory.....	192
	Overwriting the embroidery motif on the BERNINA USB stick.....	192
	Importing stitch patterns	193
	Loading an embroidery motif from the personal memory.....	193
	Loading an embroidery motif from the BERNINA USB stick	193
	Deleting an embroidery motif from the personal memory	194
	Deleting an embroidery motif from the BERNINA USB stick.....	194
16	Embroidery.....	195
16.1	Embroidering via the button «Start/Stop»	195
16.2	Increasing the embroidery speed	195
16.3	Adjusting the upper thread tension	195
16.4	Embroidering via the foot control.....	196
17	Attachment	197
17.1	Maintenance and cleaning.....	197
	Cleaning the display	197
	Cleaning the feed dog.....	197
	Cleaning the hook.....	197
	Lubricating the hook	198
17.2	Troubleshooting.....	200
17.3	Error messages.....	203
17.4	Storage and disposal	207
	Storing the machine	207
	Dispose of the machine	207
17.5	Technical data.....	208
18	Overview stitch patterns	209
18.1	Overview Stitch patterns	209
	Practical stitches	209
	Buttonholes.....	209
	Decorative stitches.....	209



IMPORTANT SAFETY INSTRUCTIONS

Please be aware of the following basic safety instructions when using your machine. Before using this machine, read instruction manual carefully.

DANGER!

To reduce the risk of electrical shock:

- Never leave the machine unattended as long as it is plugged in.
- Always unplug the machine from the electrical outlet immediately after using.

Protection against LED radiation:

- Do not view the LED light directly with optical instruments (e.g. magnifier). The LED light corresponds with protection class 1M.
- When the LED light is damaged or defective, contact your BERNINA specialist dealer.

WARNING

To reduce the risk of burns, fire, electric shock or injury to persons:

- To operate the machine always use the supplied power cable. USA and Canada only: Do not connect power plug NEMA 1-15 to circuits exceeding 150 volt-to-ground.
- Use this machine only for purposes as described in this manual.
- Only use the machine in dry rooms.
- Do not use the machine in a damp condition or in a damp environment.
- Do not use this machine as a toy. Close attention is necessary when this machine is used by or near children.
- The machine can be used by children older than 8 or by people with reduced physical, sensory or mental capabilities or if there is a lack of experience and knowledge how to operate the machine as long as they are supervised or have been given instruction concerning the responsible use of the appliance and are aware of the involved risks.
- Children are not allowed to play with this machine.
- Cleaning and maintenance work must not be carried out by children unless they are supervised.
- Never operate this machine if it has a damaged cord or plug, if it is not working properly, if it has been dropped or damaged, or dropped into water. Contact the nearest authorized BERNINA dealer to arrange further details.



Important information

Availability of the instruction manual

The instruction manual is supplied with the machine.

- Keep the instruction manual safe at a suitable place near the machine to have it at hand in case that you need to look up something.
- If you pass the machine to a third party, always include the instruction manual.

Appropriate use

Your BERNINA machine is conceived and designed for private household use. It answers the purpose to quilt fabrics as it is described in this instruction manual. Any other use is not considered appropriate. BERNINA assumes no liability concerning consequences resulting from an inappropriate usage.

Servicing of double-insulated products

In a double-insulated product two systems of insulation are provided instead of grounding. No grounding means is provided on a double-insulated product, nor should a means for grounding be added to the product. Servicing a double-insulated product requires extreme care and knowledge of the system and should be done only by qualified service personnel. Replacement parts for a double-insulated product must be identical to the original parts in the product. A double-insulated product is marked with the words: «Double insulation» or «double-insulated».

 The symbol may also be marked on the product.

Environmental Protection

BERNINA is committed to the protection of the environment. We strive to minimize the environmental impact of our products by continuously improving product design and our technology of manufacturing.



The machine is labeled with the symbol of the crossed-out wastebin. This means that the machine must not be disposed of with the household waste when the machine is no longer needed. Improper disposal can result in dangerous substances getting into the groundwater and thus into our food chain, damaging our health.

The machine must be returned free of charge to a nearby collection point for waste electrical and electronic equipment or to a collection point for the reuse of the machine. Information on the collection points can be obtained from your local administration. When purchasing a new machine, the dealer is obliged to take back the old machine free of charge and dispose of it properly.

If the machine contains personal data, you are responsible for deleting the data yourself before returning the machine.

1 My BERNINA

1.1 Introduction

With your BERNINA 790 PLUS you can sew, embroider and quilt. Delicate silk or satin fabrics as well as heavy-weight linen, fleece and denim can be sewn without any problems with this machine. Numerous practical as well as decorative stitches, buttonholes and embroidery motifs are at your disposal.

Additional to this instruction manual, subsequently listed help programs are provided which will give you useful advice and support at any time how to operate your BERNINA 790 PLUS.

The **Tutorial** gives information and explanations, covering various aspects of sewing, embroidering and the different stitches.

The **Creative Consultant** informs you about decision support for sewing projects. After entering the kind of fabric and the desired sewing project, suggestions concerning the suitable needle or the appropriate presser foot are displayed.

The **Embroidery Consultant** informs you about decision support for embroidery projects. After entering the kind of fabric and the desired embroidery project, suggestions concerning the suitable needle or the appropriate embroidery foot are displayed.

The **Help Program** contains information about individual stitch patterns, functions and applications in the display.

Further information

In addition to this instruction manual of your BERNINA 790 PLUS further information products are enclosed.

The latest version of your instruction manual as well as additional information in connection with the machine and accessories can be found on our website <http://www.bernina.com>

1.2 BERNINA Quality control

All BERNINA machines are assembled with utmost care and are subjected to an extensive functionality test. The integrated stitch counter therefore indicates that the machine has already sewn stitches, which were performed exclusively for test purposes and quality control. The subsequent thorough cleaning does not exclude the possibility that thread remnants may still be found in the machine.

1.3 Welcome to the world of BERNINA

«Made to create», is BERNINA's slogan. Not only our machines do support you to implement your ideas. On top of that, our below mentioned opportunities also offer various inspirations and instructions for your future projects as well as the option to exchange ideas with other sewing and embroidering enthusiasts. We wish you lots of pleasure doing that.

BERNINA YouTube Channel

On YouTube we offer a wide range of how-to videos and support concerning the most important functions of our machines. Detailed explanations are also provided as for the various presser feet, so that your projects will succeed completely.

<http://www.youtube.com/BerninaInternational>

Provided in the languages English and German.

inspiration – the sewing magazine

Are you looking for ideas, sewing patterns and instructions for great projects? In that case the BERNINA magazine «inspiration» is exactly what you need. «inspiration» offers extraordinary sewing and embroidery ideas four times a year. From seasonal fashion trends to trendy accessories and practical tips to decorate your home in an original way.

<http://www.bernina.com/inspiration>

The magazine is available in the languages English, German, Dutch and French. Not available in all countries.

BERNINA Blog

Fancy instructions, free sewing patterns and embroidery motifs as well as many new ideas: all this you can find in the weekly blog by BERNINA. Our experts give valuable tips and explain step by step how you can achieve the desired result. In the community you can upload your own projects and exchange experiences and ideas with other sewing and embroidering enthusiasts.

<http://www.bernina.com/blog>

Provided in the languages English, German and Dutch.

BERNINA Social Media

Follow us on the social networking to learn more about events, thrilling projects as well as tips and tricks all about sewing and embroidering. We will keep you informed and we are looking forward to presenting you the one or the other highlight from the world of BERNINA.

<http://www.bernina.com/social-media>

1.4 Explanation of symbols



Labels a danger with a high risk which can lead to death or severe injury unless it is avoided.



Labels a danger with a medium risk which can lead to death or severe injury unless it is avoided.



Designates a hazard with low risk that can cause minor or moderate injury if not avoided.



Designates a hazard that can cause property damage if not avoided.



Tips given by BERNINA **sewing experts** can be found next to this symbol.

By means of illustration, sample pictures are used in this instruction manual. The machines and accessories shown in the pictures do not necessarily correspond to the actual items delivered with your machine.



1.5 Overview Machine

Overview front controls



- | | | | |
|---|----------------------|----|----------------------------|
| 1 | Quick reverse | 7 | Pattern begin |
| 2 | Thread cutter | 8 | Needle up/down |
| 3 | Presser foot up/down | 9 | Upper Multifunctional knob |
| 4 | Start/Stop | 10 | Lower Multifunctional knob |
| 5 | Pattern end | 11 | Needle left/right |
| 6 | Securing | | |

Overview front



- | | | | |
|---|---|----|---------------------------------|
| 1 | Connection for embroidery module | 7 | Slide speed control |
| 2 | Bobbin cover | 8 | Thread take-up lever cover |
| 3 | Connection for accessory (optional accessory) | 9 | Thread take-up lever |
| 4 | Presser foot | 10 | Fixing screw |
| 5 | Needle threader | 11 | Connection for slide-on table |
| 6 | Sewing light | 12 | Connection for Free Hand System |

Overview sideways



- | | | | |
|---|--|----|-----------------------------------|
| 1 | Connection for foot control | 7 | Power switch |
| 2 | PC-connection | 8 | Connection for power cable |
| 3 | Spool holder | 9 | Magnet holder for touchscreen pen |
| 4 | Bobbin winding unit with thread cutter | 10 | Air vents |
| 5 | Swiveling spool holder | 11 | USB port |
| 6 | Handwheel | 12 | Feed dog up/down |

Overview back



- | | | | |
|---|---|----|-------------------|
| 1 | Connection for the slide-on table | 9 | Thread pretension |
| 2 | Connection for darning hoop | 10 | Thread guide |
| 3 | BSR connection | 11 | Fixing screw |
| 4 | Connection for accessory (optional accessory) | 12 | BERNINA Dual Feed |
| 5 | Air vents | 13 | Thread cutter |
| 6 | Thread guide | 14 | Feed dog |
| 7 | Bobbin winding unit | 15 | Stitch plate |
| 8 | Carrying handle | | |

1.6 Supplied accessories

Overview accessories machine

All rights reserved: For technical reasons and for the purpose of product improvements, changes concerning the features of the machine can be made at any time and without advance notice. The supplied accessory can vary depending on the country of delivery.

Please visit www.bernina.com for more accessory information.





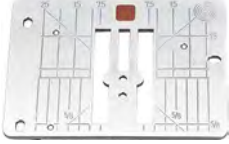















Illustration	Name	Purpose
	Soft Cover with pocket	To protect the machine from dust and contamination.
	Accessory box	To store the supplied accessories as well as the optional accessories.
	Free Hand System (FHS)	To raise and lower the presser foot.
	Slide-on table	To increase the sewing surface.
	Seam guide for slide-on table	To support wide topstitching of edges.
	CutWork/Straight stitch plate	To sew straight stitches and for CutWork.
	Spool disc	To support the regular unwinding of the thread from the spool. 3 different sizes for thread spools in different sizes.
	Bobbin 4 pieces, 1 of them in the machine	To wind the bobbin thread.
	Foam pad 2 pieces	To prevent the thread from slipping under the spool holder, tangling and breaking.

Illustration	Name	Purpose
	Touchscreen pen	For precise operation of the touch display.
	Seam ripper	To undo seams and to cut buttonholes open.
	Height compensating tool	To level an angled position of the presser foot sole when sliding over thick seams.
	Selection of needles	For any common applications.
	Seam guide, right	To align regular seam distances.
	Screwdriver Torx, gray	To change the needle.
	Screwdriver red (slot)	To loosen and tighten slotted screws.
	Angular Torx wrench Torx	To open the headframe.
	Brush	to clean the feed dog and the hook race area.
	Oil pen	To fill up the oil depots.
	Power cable	To connect the machine with the power supply system.
	Foot control	To start and stop the machine. To control the sewing speed.

Use of the power cable (only USA/Canada)

The machine has a polarized plug (one blade wider than the other). To reduce the risk of electrical shock, this plug is intended to fit in a polarized outlet only one way. If the plug does not fit fully in the outlet, reverse the plug. If it still does not fit, contact a qualified electrician to install the proper outlet. Do not modify the plug in any way!

Overview presser feet

Supplied standard presser feet









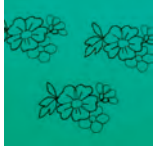

Illustration	Number	Name	Purpose	Example
	# 1C	Reverse pattern foot	To sew various practical and decorative stitches. To sew forward and in reverse.	
	# 1D	Reverse pattern foot	To sew various practical and decorative stitches with Dual Feed. To sew forward and in reverse.	
	# 2A	Overlock foot	To finish edges in stretch material.	
	# 3A	Automatic Buttonhole foot with slide	To sew buttonholes automatically.	
	# 4D	Zipper foot	To sew in zippers with Dual Feed.	
	# 5	Blindstitch foot	To sew blindstitch hems.	

Illustration	Number	Name	Purpose	Example
	# 8D	Jeans foot	To sew with Dual Feed. To sew denim.	
	# 20C	Open embroidery foot	To sew appliqués and decorative patterns.	
	# 40C	Sideways motion foot	To sew sideways motion patterns.	
	# 42	BERNINA Stitch Regulator (BSR)	Free-motion quilting with regular stitch length.	

Accessory box

All rights reserved: For technical reasons and for the purpose of product improvements, changes concerning the features of the machine can be made at any time and without advance notice. The supplied accessory can vary depending on the country of delivery.

The illustrated accessory (kind and quantity) serves as an example and doesn't have to correspond with the supplied accessory.

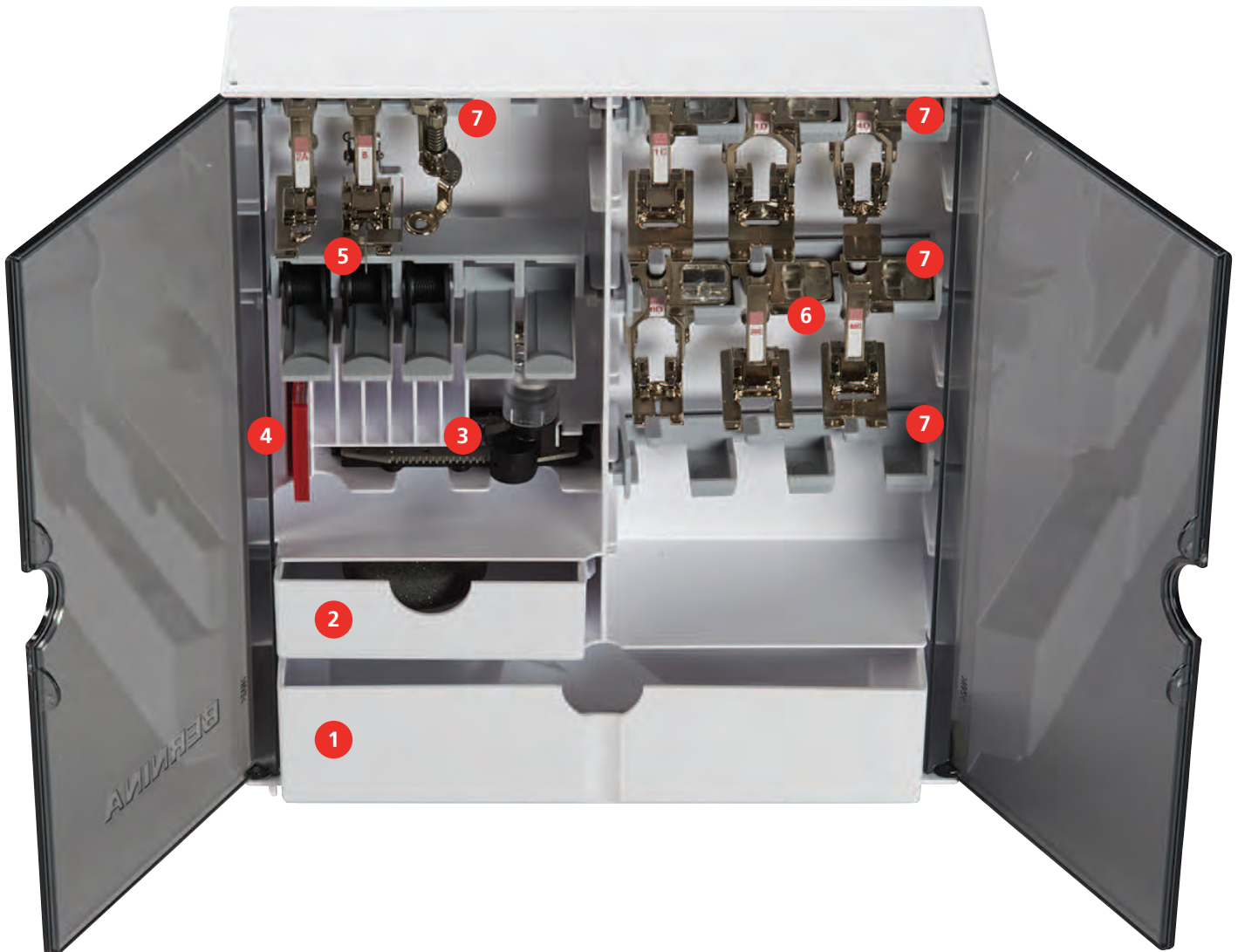

- | | | | |
|---|--------------------------------------|---|---|
| 1 | Big drawer | 5 | Spool holder |
| 2 | Small drawer | 6 | Presser feet |
| 3 | Automatic Buttonhole foot with slide | 7 | Presser foot holders for 5.5 mm and 9.0 mm feet |
| 4 | Selection of needles | | |

1.7 Overview User Interface

Overview functions/visual information



- | | | | |
|---|---|---|--------------------------------|
| 1 | Upper thread tension | 5 | Stitch plate selection |
| 2 | Needle selection | 6 | Feed dog up/down |
| 3 | Presser foot indicator/Presser foot selection | 7 | Filling level of bobbin thread |
| 4 | Presser foot pressure | | |

Overview System settings



- | | | | |
|---|---------------------|---|-------------------------|
| 1 | Home | 5 | Help |
| 2 | Setup Program | 6 | eco mode |
| 3 | Tutorial | 7 | Back to default setting |
| 4 | Creative Consultant | | |



Overview selection menu sewing



- | | | | |
|---|---------------------|---|-----------------|
| 1 | Practical stitches | 5 | Quilt stitches |
| 2 | Decorative stitches | 6 | Personal Memory |
| 3 | Alphabets | 7 | History |
| 4 | Buttonholes | | |

Overview Icons

Icon	Name	Purpose
	i-Dialog	Touching the icon «i»-Dialog provides various functions to edit motifs.
	Close	The display is closed and the previously made adjustments are saved.
	Icons «-/+»	By touching the icons «-» and «+» the setting values are changed.
	Yellow frame around the icon	A yellow-framed icon indicates that a setting or a value in this function has been changed. By touching the yellow-framed icon, the default setting can be restored.
	Confirm	Confirms the previously adjusted alterations. The display is closed.
	Cancel	The process is canceled. The display is closed and the previously made adjustments are not saved.

Icon	Name	Purpose
	Slide	By moving the slide the setting values are changed.
	Switch	Activates or deactivates functions.
	Process navigation	With the process navigation scrolling back in the display is possible.
	Swipe function	By swiping the display using the touchscreen pen or the finger upwards or downwards, further functions can be displayed.

1.8 Needle, Thread, Fabric

In the course of time a needle wears out. Therefore it should be replaced regularly. Only a perfect point results in a good stitching result. In general it can be said: the thinner the thread, the finer the needle. The illustrated needles are either standard or optional accessory, depending on the machine.

- Needle sizes 70, 75: for thin fabrics.
- Needle sizes 80, 90: for medium fabrics.
- Needle sizes 100, 110 and 120: for heavy fabrics.

Overview Needles

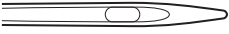









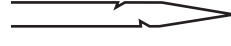

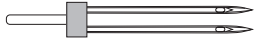



Illustration	Needle name	Needle description	Purpose
 ☒	Universal needle 130/705 H 60-120	Slightly rounded point	For nearly all natural and synthetic fabrics (woven and knitted).
 ■	Stretch needle 130/705 H-S 75, 90	Mid-sized ball point, special eye shape and needle scarf	For jersey, tricot, knit and stretch fabrics.
 ■	Jersey/Embroidery needle 130/705 H SUK 60-100	Mid-sized ball point	For knitware, knitted good. For embroidering.
 ■	Jeans needle 130/705 H-J 80-110	Point, narrow point, reinforced shaft	For heavy-weight fabrics such as jeans or canvas.
 ■	Leather needle 130/705 H LR 90, 100	With cutting point (LR = special point to sew leather)	For all types of leather, synthetic leather, plastic, sheeting.
 ■	Microtex needle 130/705 H-M 60-110	Especially sharp, narrow point	For micro fiber fabrics and silk.

Illustration	Needle name	Needle description	Purpose
 ■	Quilting needle 130/705 H-Q 75, 90	Slightly rounded fine point	For straight and topstitching.
 ■	Embroidery needle 130/705 H-E 75, 90	Small ball point, especially wide needle eye and wide thread groove	For embroidery on all natural and synthetic fabrics.
 ☒	Fine-material needle 130/705 H SES 70, 90	Small ball point	For fine knitware and knitted materials. For embroidery on fine, delicate fabrics.
 ■	Metafil needle 130/705 H METAFIL 80	Long needle eye (2 mm) in all needle sizes	For sewing or embroidering with metallic threads.
 ■	Cordonnet needle (to patch embroidery) 130/705 H-N 70-100	Long needle eye (2 mm) in all needle sizes	Topstitching with thick thread.
	Felt needle PUNCH	Needle with barbed hook	For felt work.
 ☒	Hemstitch needle 130/705 H WING 100-120	Wing-like widened needle shaft (wing)	To sew blind stitches.
 ☒	Universal double needle 130/705 H ZWI 70-100	Needle distance: 1.0/1.6/2.0/2.5/3.0/4.0/6.0/8.0	For visible hems in stretch fabrics, pintucks, decorative sewing.
 ☒	Stretch double needle 130/705 H-S ZWI 75	Needle distance: 2.5/4.0	For visible hems in stretch fabrics, pintucks, decorative sewing.
 ☒	Hemstitch double needle 130/705 H ZWIHO 100	Needle distance: 2.5	For special effects with hemstitch embroidery.
 ☒	Universal triple needle 130/705 H DRI 80	Needle distance: 3.0	For visible hems in stretch fabrics, decorative sewing.

Example for needle description

The 130/705 system, which is the most common for household machines, is explained by the following picture of a Jersey/Stretch needle.

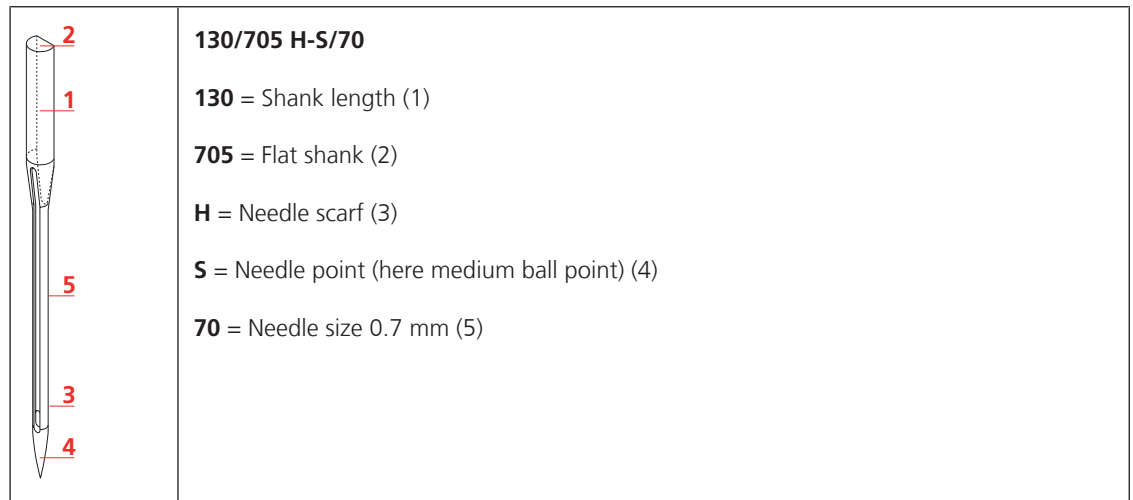

Thread selection

For a perfect sewing result, thread and fabric quality play an important role.

We recommend purchasing quality threads to achieve good sewing results.

- Cotton threads have the advantage of being a natural fiber and therefore are especially suitable for sewing cotton fabrics.
- Mercerized cotton threads have a slight sheen that is not lost with washing.
- Polyester threads have a high tensile strength and is particularly colorfast.
- Polyester threads are more flexible and are recommended where a strong and elastic seam is required.
- Rayon threads are made of natural fibers and have a brilliant sheen.
- Rayon threads are suitable for decorative stitches and achieve a more beautiful effect.

Needle/thread combination

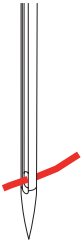
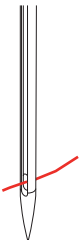
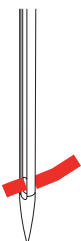
	<p>The needle/thread combination is correct, when the thread fits perfectly into the long groove and goes easily through the needle eye. The thread can be optimally secured.</p>
	<p>The thread can break and skipped stitches can occur when there is too much clearance in the long groove and the needle eye.</p>
	<p>The thread can break and get stuck when the thread scrapes against the edge of the long groove not fit well into the needle eye optimally.</p>

2 Sewing preparation

2.1 Accessory box

Accessory box free standing

- > On the back of the box, pull both extensions out until they click into place.



Storing accessory

NOTICE

Incorrect sorting of the bobbin

The silvery sensor surface can get scratched.

- > Make sure that the silvery sensor surfaces are on the right side when sorting the bobbins into the accessory box.

- > Insert the holders (1) for bobbins, feet and needles.
- > Store the small parts, e.g. thread discs etc., in the drawers (2) and (3).
- > Store the Buttonhole foot with slide No. 3A in compartment (4).
- > Store the provided needle package in the special compartment (5).
- > Insert the bobbins into the compartment (6) of the accessory box so that the silvery sensor surfaces are on the right side.
- > To remove a bobbin, press the compartment holder down.
- > Store the presser feet in the holders (7) (5.5 mm or 9.0 mm).

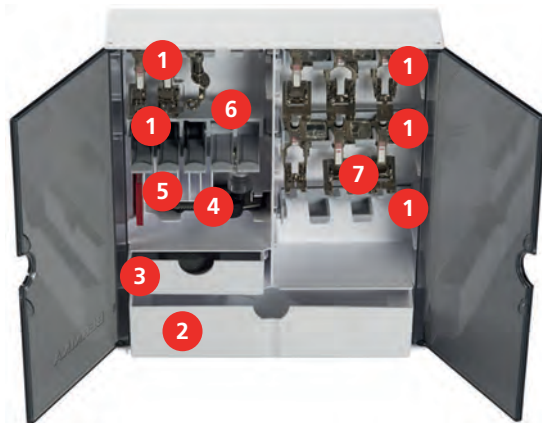

Attaching the knee lifter of the Free Hand System



The lateral position of the knee lifter can be adjusted by your local BERNINA Dealer if required.

- > Insert the knee lifter into the opening at the front side of the machine.
- > Adjust the sitting height so that the knee lifter can be operated with the knee.

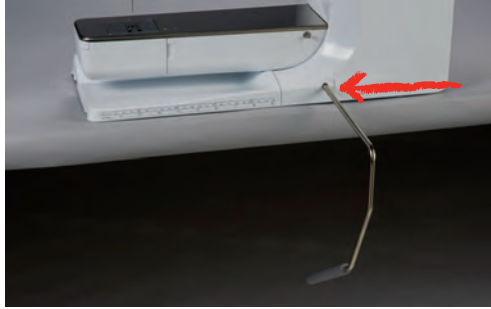

Fixing the touchscreen pen

- > Store the touchscreen pen at the magnet holder.



Switching the machine on

- > Switch on the machine at the main switch to «I».



2.3 Foot control

Regulating the speed via the foot control

Via the foot control the speed is infinitely variable.

- > Press the foot control down carefully to start the machine.
- > To sew faster, press the foot control harder.
- > Release the foot control to stop the machine.



Raising/Lowering the needle

- > Sink the heel back on the foot control to raise/lower the needle.



Programming the foot control individually

The foot control, i. e. the back kick function can be programmed individually (see page 61).



2.4 Spool pin

Swiveling spool pin

Installing the spool holder



With metallic or other special threads, it is recommend to use the swiveling spool pin.

The swiveling spool holder is necessary when several threads are sewn and it can also be used for bobbin winding while sewing.

- > Swivel the spool holder up as far as it will go.



Inserting foam pad and thread spool

The foam pad prevents the thread from getting hooked at the swiveling spool holder.

- > Place the foam pad on the swiveling spool holder.
- > Place the thread spool on the spool holder.



Horizontal spool pin

Placing the foam pad, the thread spool and the spool disc

The spool disc provides an even unwinding of the thread from the thread spool. The spool disc is only used with the horizontal spool pin.

- > Place the foam pad on the spool pin.
- > Place the thread spool on the spool pin.



- > Position the appropriate spool disc on the spool pin so that there is no space between the spool disc and the thread spool.



Using a spool net

The spool net provides an even unwinding of the thread from the thread spool and prevents the thread from knotting and breaking. The spool net is only used with the horizontal spool holder.

- > Pull the spool net over the thread spool.



2.5 Free arm

The BERNINA 790 PLUS provides a solidly designed free arm which offers a lot of space for large project on the right of the needle.



2.6 Feed dog

Adjusting the feed dog

NOTICE

Inappropriate handling of the fabric

Damage of the needle and the stitch plate.

> Let the sewing project be fed evenly.

With each stitch, the feed dog moves forward by one step. The length of this step is determined by the stitch length selected.

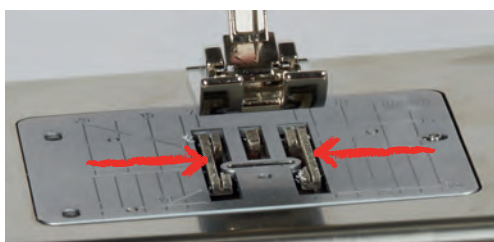

With a short stitch length, the steps are very short. For example when sewing buttonholes and satin stitches. The fabric is fed slowly under the presser foot, even when sewing at maximal speed.

	<p>Let the fabric be fed evenly; this results in a more perfect stitch formation.</p>
	<p>Pulling or pushing the fabric will result in uneven stitches.</p>
	<p>Holding back the fabric will result in uneven stitches.</p>

> Push the button «Feed dog up/down» to lower the feed dog.



> Push the button again to sew with the feed dog up.

2.7 Slide-on table

Using the slide-on table

When attached to the free arm, it expands the already existing sewing area.

- > Raise the needle.
- > Raise the presser foot.
- > Switch the machine off and disconnect it from the power supply system.
- > Push the slide-on table to the right over the free arm until it engages.



- > To remove the slide-on table, press the button at the table down and pull the slide-on table over the free arm to the left.



Attaching the seam guide

Prerequisite:

- The slide-on table is attached.
- > Press the release button of the seam guide to insert it into the groove of the slide-on table from left or right.



2.8 Presser foot

Adjusting the presser foot position via the knee lifter of the Free Hand System

- > Adjust the sitting height so that the knee lifter can be operated with the knee.
- > Push the knee lifter with the knee to the right to raise the presser foot.

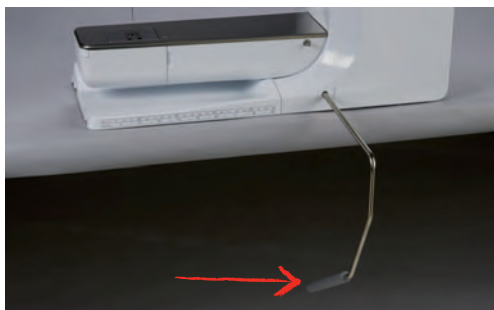

- Simultaneously the feed dog is lowered and the thread tension is released.
- > Release the knee lifter slowly to lower the presser foot.

Adjusting the presser foot position via the button «Presser foot up/down»



- > Push the button «Presser foot up/down» to raise the presser foot.
- > Push the button «Presser foot up/down» again to lower the presser foot.

Changing the presser foot

- > Raise the needle.
- > Raise the presser foot.
- > Switch the machine off and disconnect it from the power supply system.
- > Push the clamping lever up.



- > Remove the presser foot.
- > Guide the new presser foot upwards over the cone.
- > Press the clamping lever down.

Selecting the presser foot in the user interface

After the presser foot has been changed, it can be checked whether or not the presser foot is suitable for the selected stitch pattern. In addition to that, alternative presser feet are displayed which are available for the currently selected stitch pattern.

- > Switch the machine on.
- > Select a stitch pattern.
- > Touch the icon «Presser foot display/Presser foot selection».





- > Touch the icon «Optional presser feet» to display all suitable presser feet for the selected stitch pattern.
- > Touch the icon «Scrolling right» to view additional suitable presser foot options.



- > Select the attached presser foot.
 - When the selected presser foot is suitable, sewing can start.
 - When the selected presser foot is not suitable for the wanted stitch pattern, starting the machine is automatically blocked. An error message is displayed. With an inappropriately selected presser foot, the stitch pattern is displayed in red in the stitch pattern preview.



Adjusting the presser foot pressure



The presser foot pressure is designed to adjust the pressure of the presser foot optimally to the fabric thickness. When working with thick fabrics, it is recommended to reduce the presser foot pressure. This provides the advantage that the presser foot is slightly lifted so that the fabric can be moved more easily. When working with thin fabrics, it is recommended to increase the presser foot pressure. This provides the advantage that the fabric cannot be moved too easily under the presser foot.



- > Touch the icon «Presser foot pressure».
- > Move the slide with the touchscreen pen/finger to adjust the presser foot pressure.

2.9 Instruction for adjusting the feed dog



- > Touch the icon «Feed dog up/down».
- > Raise or lower the feed dog according to the animation.

2.10 Needle and stitch plate

Changing the needle

- > Raise the needle.
- > Switch the machine off and disconnect it from the power supply system.
- > Remove the presser foot.
- > Loosen the fixing screw of the needle using the screwdriver gray Torx.



- > Pull the needle down.
- > Hold the new needle with the flat side to the back.
- > Insert the needle as far as it will go.
- > Tighten the fixing screw of the needle using the screwdriver gray Torx.

Selecting the needle in the User Interface

After having changed the needle, it can be checked whether or not it is suitable to be used together with the selected stitch plate.



- > Touch the icon «Needle selection».
- > Select the inserted needle.



- If the selected needle is suitable in combination with the selected presser foot, sewing can be started. If the selected needle is not suitable in combination with the selected presser foot, an error message appears and sewing cannot be started.

Selecting needle type and needle size

Convenient memory function: To prevent a loss of information, the needle type and the needle size can be saved additionally on the machine. The saved needle type and the saved needle size can be checked at any time.



- > Touch the icon «Needle selection».



- > Touch the icon «Needle type/Needle size».
- > Select the needle type (1) of the inserted needle.
- > Select the needle size (2) of the inserted needle.



Adjusting the needle position up/down



- > Push the button «Needle up/down» to lower the needle.
- > Push the button «Needle up/down» again to raise the needle.

Adjusting the needle position left/right

There is a total of 11 needle positions. The needle position is indicated by the needle position number in the display.

- > Push the button «Needle left» (1) to move the needle to the left.
- > Push the button «Needle right» (2) to move the needle to the right.



Needle stop up/down (permanent)



- > Touch the icon «Needle stop up/down (permanent)» to fix the needle position permanently.
 - The machine stops with needle position down as soon as the foot control is released or the button «Start/Stop» has been pressed.

- > Touch the icon «Needle stop up/down (permanent)» again.
 - The machine stops with needle position up as soon as the foot control is released or the button «Start/Stop» has been pressed.

Changing the stitch plate

The stitch plate is marked with vertical, horizontal and diagonal lines in millimeters (mm) and inches (inch). These lines help to guide the fabric when sewing seams and precise topstitching.

Prerequisite:

- The feed dog is lowered.
 - The machine is switched off and disconnected from the power supply system.
 - Needle and presser foot are removed.
- > Press the stitch plate down at the mark back right until it flips up.



- > Remove the stitch plate.
- > Place the openings of the new stitch plate above the corresponding guide pins and press down until it clicks into place.

Selecting the stitch plate in the User Interface

After having changed the stitch plate, it can be checked whether or not it is suitable to be used together with the selected needle.



- > Touch the icon «Stitch plate selection».
- > Select the previously attached the stitch plate.



- If the selected stitch plate is suitable in combination with the needle, sewing can be started.
- If the selected stitch plate is not suitable in combination with the needle, starting the machine is automatically blocked.

2.11 Threading

Threading the upper thread

Prerequisite:

- The needle and the presser foot are raised.
 - The machine is switched off and disconnected from the power supply system.
- > Place the foam pad on the spool holder.
 - > Place the thread spool on the spool holder so that the thread unwinds clockwise.
 - > Add the appropriate spool disc.
 - > Guide the thread in direction of the arrow through the rear thread guide (1) and hold the thread with the hands so that it is taut and can be inserted into the thread tension.
 - > Guide the thread in direction of the arrow through the thread tension (2).



- > Guide the thread downwards (3) around the thread take-up lever cover (4).
- > Guide the thread upwards and insert into the thread take-up lever (5).
- > Guide the thread downwards again (6).



- > Guide the thread through the guides (7/8) above the presser foot.

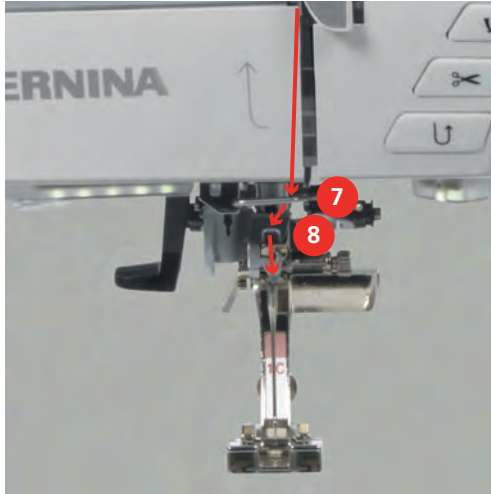

- > Switch the machine on.
- > Press the semi-automatic threader lever (9) slightly down, keep pressed and pull the thread to the left beneath the gray threader hook (10).



- > Guide the thread around the gray threader hook from the left to the right (12).
- > Press the threader lever down as far as it will go (11) and then pull the thread from the left to the right (12) through the threader slot (13) until it hooks into the small wire hook.

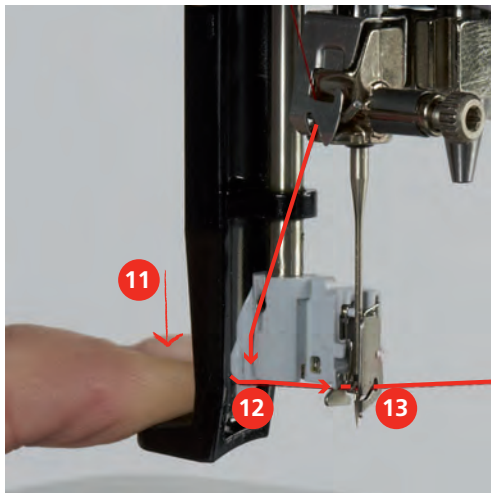

- > Release the lever and the thread simultaneously to thread.
- > Pull the thread loop (14) to the back.

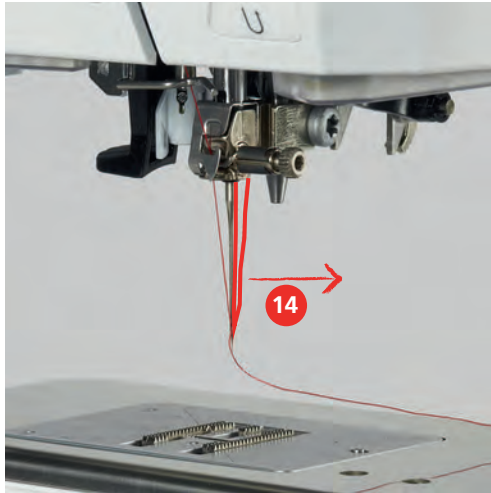

- > Pull the thread beneath the presser foot from back to front over the thread cutter (15) and cut.



Threading the double needle

Prerequisite:

- The double needle is inserted.
- > Guide the first thread in direction of the arrow on the right side of the tension disc (1).
- > Guide the second thread in direction of the arrow on the left side of the tension disc (1).



- > Guide the first and the second thread to the thread guide above the needle.
- > Thread the first thread manually into the right needle.

- > Thread the second thread manually into the left needle.

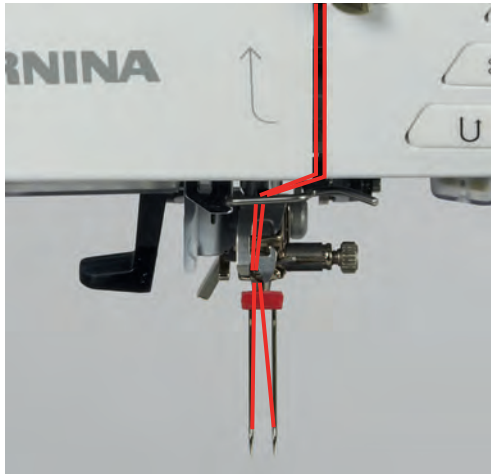

Threading the triple needle

Always attach a foam pad when using the swiveling spool holder. This prevents the thread from getting hooked at the spool holder.

Prerequisite:

- The triple needle is inserted.
 - > Place the foam pad, the thread spool and the appropriate spool disc on the spool holder.
 - > Place the filled bobbin on the swiveling spool holder.
 - > Add the appropriate spool disc.
 - > Place the thread spool.
 - > Thread the 3 threads up to the upper thread guide.

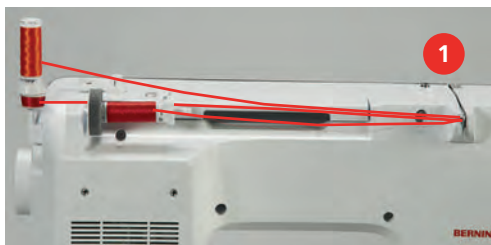

- > Guide 2 threads past the thread tension discs (1) on the left and to the thread guide above the needle.
- > Guide 1 thread past the thread tension discs (1) on the right and to the thread guide above the needle.
- > Thread the first thread into the left needle manually.
- > Thread the second thread into the center needle manually.
- > Thread the third thread into the right needle manually (see page 51).



Winding the bobbin thread



The bobbin thread can be wound while embroidering if the swiveling spool holder is used for winding.

Prerequisite:

- The foam pad, the thread spool and the appropriate thread disc are positioned.
- > Attach the empty bobbin on the winding unit (1) so that the silvery sensor surface is down.



- > Guide the thread to the left into the rear thread guide (2).
- > Guide the thread around the thread pretension clockwise (3).
- > Wind the thread clockwise 2 to 3 times around the empty bobbin (4).

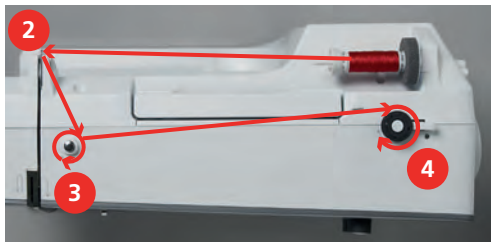

- > Pull the excess thread over the thread cutter at the engaging lever (5) and cut.

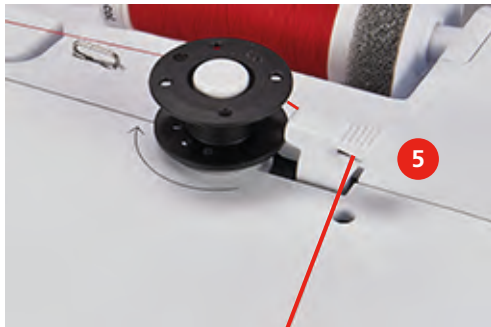

- > Push the engaging lever (6) towards the bobbin.



- The machine winds and the display to wind the bobbin appears.
- > Move the slide on the display using the touchscreen pen/finger to adjust the winding speed.
- > To stop the winding process, the engaging lever must be pressed to the right.

- > Pull the thread into the slot (2) from the left.



- > Pull the thread to the right under the spring (3), then lead the thread under the two thread guides (4) and pull upwards.



- > When inserting into the machine, hold the bobbin case so the thread guide (5) points upwards.

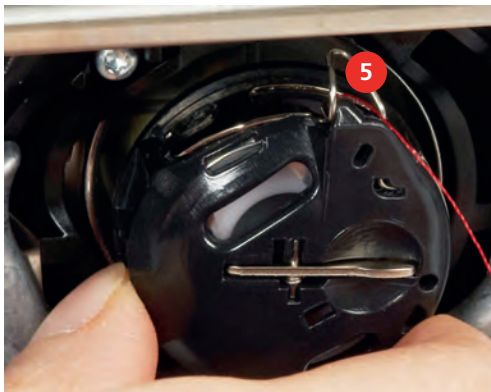

- > Insert the bobbin case.
- > Press onto the center of the bobbin case until it engages.

- > Pull the thread through the thread cutter (6) and cut.

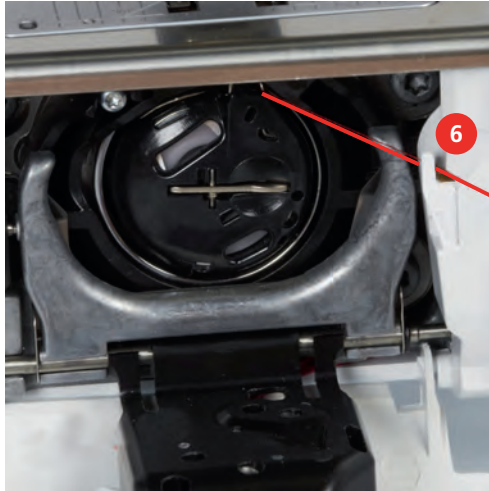

- > Close the bobbin cover.

Indicating fill level of bobbin thread

As soon as the fill level of the bobbin thread is low, an animation, which indicates that the bobbin thread is running out, appears in the icon «Bobbin thread fill level».



- > Touch the icon «Bobbin thread fill level» to thread the bobbin thread according to the animation.



3 Setup Program

3.1 Sewing settings

Adjusting the upper thread tension

Adjustments to the upper thread tension in the Setup Program affect all stitch patterns. Individual alteration of the upper thread tension can also be made for currently selected stitches.



> Touch the icon «Setup Program».



> Touch the icon «Sewing settings».



> Touch the icon «Alter the upper thread tension».

> Move the slide using the touchscreen pen/finger or touch the icons «+» or «-» to alter the upper thread tension.

Adjusting the maximum sewing speed

By using this function, the maximum speed can be reduced.



> Touch the icon «Setup Program».



> Touch the icon «Sewing settings».



> Touch the icon «Alter the maximum speed».

> Move the slide using the touchscreen pen/finger or touch the icons «+» or «-» to alter the maximum speed.

Programming the securing stitches

If the function is activated, 4 securing stitches are sewn automatically at the pattern start after the thread cut.



> Touch the icon «Setup Program».



> Touch the icon «Sewing settings».



> Touch the switch using the touchscreen pen/finger to deactivate the securing stitches.

> Touch the switch again to activate the securing stitches.

Adjusting the hovering height of the presser foot

The hovering height of the presser foot can be adjusted according to the fabric thickness from 0 to maximal 7 mm.



> Touch the icon «Setup Program».



> Touch the icon «Sewing settings».



> Touch the icon «Program buttons and icons».



> Touch the icon «Program the hovering position of the presser foot».
 > To adjust the distance between the fabric and the presser foot, turn the «Upper Multifunction knob» or the «Lower Multifunction knob» or touch the icons «-» or «+».

Programming the button «Pattern end»

The presser foot can be positioned, the thread cut and the automatic securing can be programmed.



> Touch the icon «Setup Program».



> Touch the icon «Sewing settings».



> Touch the icon «Program buttons and icons».



> Touch the icon «Program pattern end».



> Touch the icon «Secure» to sew 4 securing stitches in place.

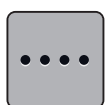

> Touch the icon «Alter the number of securing stitches» to program subsequent securing stitches.
 > Touch the icons «-» or «+» to program the number of securing stitches in close succession.

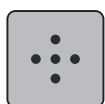

> Touch the icon «Securing stitches in place» to program 4 securing stitches in place.



> Touch the icon «Thread cut» to deactivate the automatic thread cut after securing.
 > Touch the icon «Thread cut» again to activate the automatic thread cut after securing.



> Touch the icon «Position the presser foot» so that the presser foot remains down after securing.
 > Touch the icon «Position the presser foot» again so that the presser foot remains up after securing.



> Touch the icon «Secure» to deactivate the automatic securing.
 > Touch the icon «Secure» again to activate the automatic securing.

Programming the button «Thread cutter»

The automatic securing can be programmed before the thread cut takes place.



> Touch the icon «Setup Program».



> Touch the icon «Sewing settings».



> Touch the icon «Program buttons and icons».



> Touch the icon «Program the button thread cutter».



> Touch the icon «Secure» to program 4 securing stitches in place.



> Touch the icon «Number of securing stitches» to program the number of securing stitches in close succession.

> Touch the icons «-» or «+» to program the number of securing stitches.



> Touch the icon «Securing stitches in place» to program 4 securing stitches in place.



> Touch the icon «Securing» to deactivate the automatic securing.

> Touch the icon «Securing» again to activate the automatic securing.

Adjusting the presser foot position with needle stop down

With lowered needle, 3 different presser foot position can be selected: the presser foot lowered, the presser foot is raised to hovering position and the presser foot is raised to its maximum height.



> Touch the icon «Setup Program».



> Touch the icon «Sewing settings».



> Touch the icon «Program buttons and icons».



> Touch the icon «Adjust the presser foot position with needle stop down».



> Select the desired presser foot position.

Programming the button «Quick reverse»

It can be chosen either «Quick reverse permanent» or «Backstepping».



> Touch the icon «Setup Program».



> Touch the icon «Sewing settings».



> Touch the icon «Program buttons and icons».



> Touch the icon «Program Quick reverse».



> Touch the icon «Backstepping» to activate backstepping.

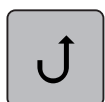

> Touch the icon «Quick reverse permanent» to activate the permanent reverse sewing.

Programming the button «Securing»

Number and type of securing stitches can be programmed.



> Touch the icon «Setup Program».



> Touch the icon «Sewing settings».



> Touch the icon «Program the buttons and icons».



> Touch the icon «Program the button Securing».



> Touch the icon «Alter the number of securing stitches» to program securing stitches in close succession.

> Touch the icons «-» or «+» to program the number of securing stitches.

> Touch the yellow-framed icon to reset the alteration to default setting.

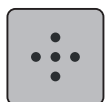

> Touch the icon «Securing stitches in place» to program 4 securing stitches in place.

Programming the foot control

When the icon «Needle up/down» is activated, the needle is raised or lowered via a back kick on the foot control. Alternatively, the presser foot can be positioned, the thread can be cut and the automatic securing can be programmed.



> Touch the icon «Setup Program».



> Touch the icon «Sewing settings».



> Touch the icon «Program the foot control».

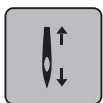

- The icon «Needle up/down» is activated by default.
- The back kick on the foot control raises or lowers the needle.



> Touch the icon «Program the back kick» to program the back kick.



> To program 4 securing stitches in place, touch the icon «Securing».



- > To program securing stitches in close succession, touch the icon «Alter the number of securing stitches».
- > To program the number of securing stitches, touch the icons «-» or «+».
- > To reset any alterations to default setting, touch the yellow-framed icon.



> To program 4 securing stitches in place, touch the icon «Securing stitches in place».



- > To deactivate the automatic securing via the back kick, touch the icon «Securing».
- > To activate the automatic securing via the back kick, touch the icon «Securing» again.



- > To deactivate the automatic thread cut, touch the icon «Thread cut».
- > Touch the icon «Thread cut» again to activate the thread cut via the back kick.



- > Touch the icon «Position the presser foot» so that the presser foot remains down via the back kick.
- > Touch the icon «Position the presser foot» again so that the presser foot remains up via the back kick.

3.2 Embroidery settings

Adjusting the upper thread tension

Alterations of the upper thread tension in the Setup Program affect all embroidery motifs.



- > Touch the icon «Setup Program».



- > Touch the icon «Embroidery settings».



- > Touch the icon «Alter the upper thread tension».
- > Move the slide using the touchscreen pen/finger or touch the icons «+» or «-» to alter the upper thread tension.

Adjusting the maximum embroidering speed

By using this function, the maximum speed can be reduced.



- > Touch the icon «Setup Program».



- > Touch the icon «Embroidery settings».



- > Touch the icon «Alter the maximum speed».
- > Move the slide using the touchscreen pen/finger or touch the icons «+» or «-» to alter the maximum speed.

Centering or opening embroidery motifs in the original position

When the embroidery motif is opened on the machine, it is always centered to the embroidery hoop. If you want the embroidery motif to be opened in its original position (defined by the BERNINA embroidery software), the function «Center the embroidery motif» must be activated.



- > Touch the icon «Setup Program».



- > Touch the icon «Embroidery settings».



- > Touch the icon «Center the embroidery motif».



- > Press the switch in the right section.
 - A previously moved embroidery motif which has been saved in the new position is opened in the saved position after selecting.
- > Press the switch in the right section again.
 - The embroidery motif is centered to the embroidery hoop.

Calibrating the embroidery hoop

The calibration of the embroidery hoop is the coordination of the needle to the center of the embroidery hoop.

Prerequisite:

- The embroidery module is connected and the embroidery hoop with the appropriate embroidery template is attached.



> Touch the icon «Setup Program».



> Touch the icon «Embroidery settings».



- > Touch the icon «Calibrate the hoop».
 - The machine recognizes the embroidery hoop automatically.
- > Touch the icon «Delete» (1) to delete the present calibration.
- > Center the needle via the arrow icons on the display.

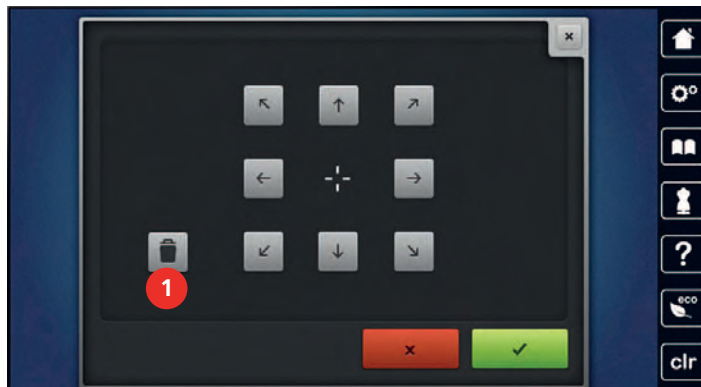

> Touch the icon «Confirm» to save the calibration.

Entering the fabric thickness

If the fabric thickness is more than 4 mm as for e.g. toweling, it is recommended to select 7.5 mm or 10 mm. The thicker the fabric, the slower the embroidery speed of the machine. When the machine is switched off, the alterations are reset to the default setting 4 mm.



> Touch the icon «Setup Program».



> Touch the icon «Embroidery settings».



- > Touch the icon «Select the fabric thickness».
- > Select fabric thickness.

Activating/Deactivating the function thread away

To pull the thread end out of the fabric being cut, the function must be activated. For embroidery motifs with long stitches, it is recommended to deactivate the function thread away. When the distance between the presser foot and the embroidery hoop is too short, the function is not carried out.



> Touch the icon «Setup Program».



> Touch the icon «Embroidery settings».



> Touch the icon «Thread away».



- > To activate the function thread away, set the switch to «1».
- > To deactivate the function thread away, set the switch to «0».

Programming the securing stitches

Embroidery motifs are programmed either with or without securing stitches. The machine recognizes when no securing stitches are programmed and adds some. If securing stitches are not wanted, they can be deactivated.



> Touch the icon «Setup Program».



> Touch the icon «Embroidery settings».



> Touch the icon «Securing stitches on/off».



- > Press the switch in the upper right section to deactivate the securing stitches at the start.
 - If the embroidery motif has programmed securing stitches, they will be embroidered.
 - If the embroidery motif doesn't have any programmed securing stitches, none are embroidered.
- > Press the switch again to activate the securing stitches at the start.
 - If the embroidery motif has programmed securing stitches, they will be embroidered.
 - If the embroidery motif doesn't have any programmed securing stitches, the securing stitches are added and will be embroidered.
- > Press the switch in the lower right section to deactivate the securing stitches at the end.
 - If the embroidery motif has programmed securing stitches, they will be embroidered.
 - If the embroidery motif doesn't have any programmed securing stitches, none are embroidered.
- > Press the switch again to activate the securing stitches at the end.
 - If the embroidery motif has programmed securing stitches, they will be embroidered.
 - If the embroidery motif doesn't have any programmed securing stitches, the securing stitches are added and will be embroidered.

Adjusting the thread cut

The settings for the thread cut can be customized. Deactivate the thread cut after a color change (1) or adjust the length of the connecting stitch (3). The machine does the cutting of the connecting threads at the determined length for you. Please adjust the length first from where the connecting stitches are to be cut. Then select the embroidery motif.



> Touch the icon «Setup Program».



> Touch the icon «Embroidery settings».



> Touch the icon «Thread cut settings».

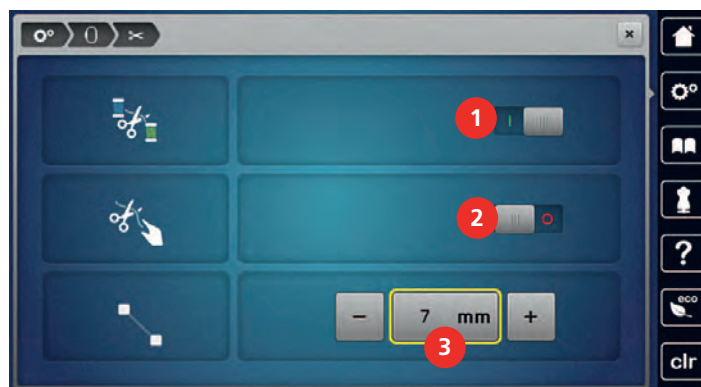

- > Touch the switch in the upper portion of the display (1) to deactivate the automatic thread cut before the thread is changed.
- > Touch the switch in the upper portion of the display (1) again to activate the automatic thread cut before the thread is changed.
- > Touch the switch in the middle section of the display (2) so that the machine will stop after about 7 stitches and the remaining thread can be cut manually.
- > Touch the switch in the middle section of the display (2) again and the machine won't stop for a manual thread cut.
- > Touch the icons «-» or «+» (3) to adjust the length from where the connecting stitches are cut.
- > Touch the yellow-framed icon to reset any alterations to default setting.

Changing the measuring unit

The measuring unit in the embroidery mode can be changed from mm to inch. The standard setting is in mm.



> Touch the icon «Setup Program».



> Touch the icon «Embroidery settings».



- > Touch the icon «Change measuring unit».
- > Touch the icon «Inch» (2) to change the measuring unit in the embroidery mode to inch.

- > Touch the icon «mm» (1) to change the measuring unit in the embroidery mode to mm.

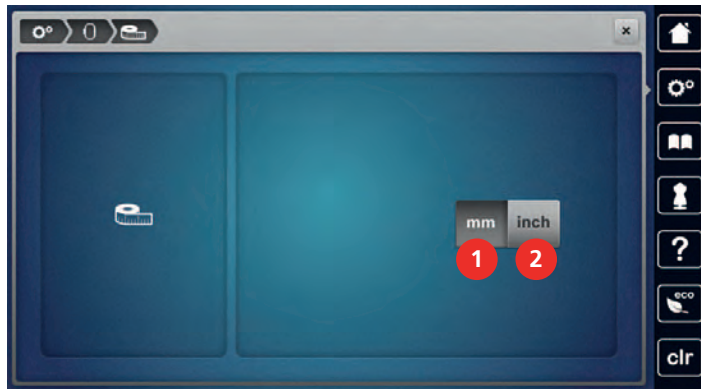

3.3 Selecting personal settings



- > Touch the icon «Setup Program».



- > Touch the icon «Personal settings».
- > Select the desired color of the display and the background.
- > Touch the text box above the color settings.



- > Enter the welcome text.
- > Touch the icon «ABC» (standard setting) to use upper-case letters.
- > Touch the icon «abc» to use lower-case letters.
- > Touch the icon «123» to use figures and mathematical symbols.
- > Touch the icon «@&!» to use special characters.
- > Touch the text box above the keyboard to delete the entered text completely.
- > Touch the icon «DEL» to delete individual syllables of the entered text.



- > Touch the icon «Confirm».

3.4 Monitoring functions

Activating the upper thread indicator



- > Touch the icon «Setup Program».



- > Touch the icon «Monitoring settings».



- > Touch the switch in the upper portion of the display to deactivate the upper thread indicator.
- > Touch the switch again to activate the upper thread indicator.

Activating the bobbin thread indicator



- > Touch the icon «Setup Program».



- > Touch the icon «Monitoring settings».



- > Touch the switch in the lower section of the display to deactivate the bobbin thread indicator.
- > Touch the switch again to activate the bobbin thread indicator.

3.5 Activating the audio signals



- > Touch the icon «Setup Program».



- > Touch the icon «Audio signals».
- > Touch the switch (1) to deactivate any audio signals in general.
- > Touch the switch (1) again to activate any audio signals in general.
- > In the section (2) touch the icons «1 – 4» to set up the desired signal for the selection of a stitch pattern.
- > In the section (2) touch the icon «Loudspeaker» to deactivate the signal for the selection of a stitch pattern.
- > In the section (3) touch the icons «1 – 4» to activate the signal for the selection of functions.



- > In the section (3) touch the icon «Loudspeaker» to deactivate the signal for the selection of functions.



- > In the section (4) touch the icon «Loudspeaker» to deactivate the signal when using the BSR modes.



- > In the section (4) touch the icon «Loudspeaker» again to activate the signal when using the BSR modes.

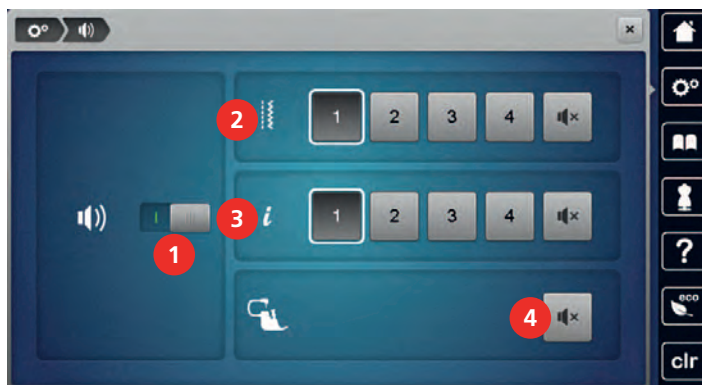

3.6 Machine settings

Selecting a language

The User Interface can be programmed in different languages according to the customer's wish because BERNINA provides a wide range of international languages for the customers. Via firmware updates additional languages for the User Interface can be provided.



- > Touch the icon «Setup Program».



- > Touch the icon «Machine settings».



- > Touch the icon «Language selection».
- > Select a language.

Adjusting the brightness of the display

The brightness of the display can be adjusted corresponding to the personal preferences.



- > Touch the icon «Setup Program».



- > Touch the icon «Machine settings».



- > Touch the icon «Adjust the brightness».
- > Move the slide in the upper portion of the display using the touchscreen pen/finger or touch the icons «+» or «-» to alter the brightness of the display.

Adjusting the sewing light





The brightness of the sewing light can be adjusted corresponding to the personal preferences.



- > Touch the icon «Setup Program».









Setup Program

-  > Touch the icon «Default setting embroidery».
-  > Touch the icon «Confirm» to restore the default settings for the embroidery settings.
-  > Touch the icon «Default setting all».
-  > Touch the icon «Confirm» and restart the machine to restore all default settings.





Deleting user data

Motifs which are not needed anymore can be deleted so that there will be more capacity for new motifs.

-  > Touch the icon «Setup Program».
-  > Touch the icon «Machine settings».
-  > Touch the icon «Default settings».
-  > Touch the icon «Delete data from the personal memory».
-  > Touch the icon «Confirm» to delete all data from the personal memory.
-  > Touch the icon «Delete personal embroidery motifs».
-  > Touch the icon «Confirm» to delete all embroidery motifs from the personal memory.

Deleting motifs on the BERNINA USB Stick

When motifs which won't be needed anymore are saved on the BERNINA USB Stick (Optional accessory), the stick can be connected to the machine and the data can be deleted.

- > Insert the BERNINA USB Stick (Optional accessory) into the den USB port of the machine.
-  > Touch the icon «Setup Program».
-  > Touch the icon «Machine settings».
-  > Touch the icon «Basic settings».
-  > Touch the icon «Delete data from USB Stick».
-  > Touch the icon «Confirm» to delete all data on the BERNINA USB Stick (Optional accessory).



Calibrating the Buttonhole foot No. 3A

The Buttonhole foot No. 3A is calibrated to this machine and they should only be used both together.

Prerequisite:

- The Buttonhole foot No. 3A is attached.
- The needle is not threaded.



> Touch the icon «Setup Program».



> Touch the icon «Machine settings».



> Touch the icon «Maintenance/Update».



> Touch the icon «Calibrate the Buttonhole foot with slide No. 3A».



> Touch the button «Start/Stop» to start the calibration.

Updating the machine Firmware

The latest firmware of the machine and a detailed step-by-step instruction for updating processes can be downloaded at www.bernina.com. In general, personal data and settings are automatically transferred during a firmware update. For reasons of safety, it is also recommended to save data and settings on a BERNINA USB stick (optional accessory) before the firmware update is started. If personal data and settings should get lost during a firmware update, they can be transferred to the machine again afterwards.

NOTICE

The BERNINA USB stick (optional accessory) has been removed too early

Firmware has not been updated and the machine cannot be used.

> Remove the BERNINA USB stick (optional accessory) only after the update has been completed successfully.

> Insert the BERNINA USB stick (optional accessory), FAT32 formatted, providing the latest software into the port.



> Touch the icon «Setup Program».



> Touch the icon «Machine settings».



> Touch the icon «Maintenance/Update».



> Touch the icon «Update the machine».

Setup Program

- > Touch the icon «Save data on USB stick».
 - The icon is checkmarked in green.
- Update** > Touch the icon «Update» to start the update of the firmware.

Recovering saved data

If personal data and settings after a software update are not available anymore, they can be transferred to the machine again afterwards.

NOTICE

The BERNINA USB stick (optional accessory) has been removed too early

Saved data cannot be transferred and the machine cannot be used.

- > Remove the BERNINA USB stick (optional accessory) only after the saved data has been transferred successfully.

- > Insert the BERNINA USB stick (optional accessory) providing the saved data and settings into the USB port of the machine.



- > Touch the icon «Setup Program».



- > Touch the icon «Machine settings».



- > Touch the icon «Maintenance/Update».



- > Touch the icon «Update the machine».



- > Touch the icon «Transfer saved data to machine».
 - The icon is checkmarked in green.

Cleaning the thread catcher

In chapter «Maintenance and cleaning» there are additional illustrated step-by-step instructions.



- > Touch the icon «Setup Program».



- > Touch the icon «Machine settings».



- > Touch the icon «Maintenance/Update».



- > Touch the icon «Clean the thread catcher».
- > Clean the thread catcher according to the instructions on the display.

Lubricating the machine

The Setup Program provides animations how the machine has to be oiled. In chapter «Maintenance and cleaning» there are additional illustrated step-by-step instructions. Always use BERNINA oil to lubricate.



Electronically driven components

Risk of injury near the needle and the hook.

- > Switch the machine off and disconnect it from the power supply system.



Lubricating the hook

Too much oil can pollute the fabric and the thread.

- > Always sew a test sample first.



- > Touch the icon «Setup Program».



- > Touch the icon «Machine settings».



- > Touch the icon «Maintenance/Update».



- > Touch the icon «Lubricate the machine».
- > Lubricate the machine according to the instructions on the display.

Packing the embroidery module

To pack the embroidery module into the original packaging without moving the embroidery arm manually, the embroidery arm needs to be brought to its packing position.

Prerequisite:

- The embroidery module is connected with the machine.



- > Touch the icon «Setup Program».



- > Touch the icon «Machine settings».



- > Touch the icon «Maintenance/Update».



- > Touch the icon «Pack position for the embroidery module».
- > Follow the instructions on the display.

Checking the firmware version

Both the firmware and the hardware version of the machine and the attached embroidery module are displayed.



> Touch the icon «Setup Program».



> Touch the icon «Machine settings».



> Touch the icon «Information».



> Touch the icon «Firmware and hardware information».

Reviewing the total number of stitches

The total number of stitches of the machine as well as the number of stitches since the last service carried out by the specialized BERNINA dealer are displayed.



> Touch the icon «Setup Program».



> Touch the icon «Machine settings».



> Touch the icon «Information».



> Touch the icon «Firmware und Hardware Informationen».

Registering details of the dealer

The contact details of your specialized BERNINA dealer can be registered.



> Touch the icon «Setup Program».



> Touch the icon «Machine settings».



> Touch the icon «Information».



> Touch the icon «Dealer details» to enter the information of the specialized dealer.



> Touch the icon «Name of the shop» to enter the name of the specialized BERNINA dealer.



> Touch the icon «Address» to enter the address of the specialized BERNINA dealer.



> Touch the icon «Phone» to enter the telephone number of the specialized BERNINA dealer.



> Touch the icon «Internet» to enter the Internet homepage or the email address of the specialized BERNINA dealer.

Saving Service data

Service data concerning the status quo of the machine can be saved on a BERNINA USB stick (Optional accessory) and then given to the BERNINA dealer this way.

> Insert a BERNINA USB stick (Optional accessory) which provides enough free memory space into the USB port.



> Touch the icon «Setup Program».



> Touch the icon «Machine settings».



> Touch the icon «Information».



> Touch the icon «Service data».

> Touch the icon «LOG».

– The icon «LOG» is outlined in white.

> Only when the icon is not outlined in white anymore, remove the BERNINA USB Stick (Optional accessory).

Displaying the ID number of the machine



> Touch the icon «Setup Program».



> Touch the icon «Machine settings».



> Touch the icon «Information».



- > Touch the icon «ID Number».
- The ID number of the machine is displayed.

Performing the upgrade

The upgrade is fee-based and has to be activated via an activation key.



- > Touch the icon «Setup Program».



- > Touch the icon «Machine settings».



- > Touch the icon «Information».



- > Touch the icon «UPGRADE».

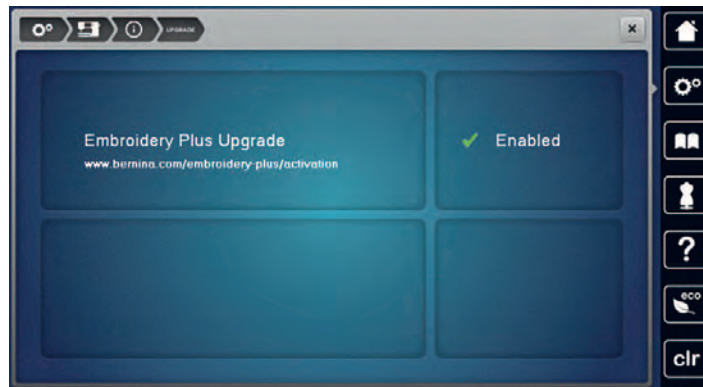

- Enabled means that the update has been successful.

4 System settings

4.1 Calling up the Tutorial

The tutorial provides information and explanations on different sections concerning sewing and embroidering and the various stitches.



- > Touch the icon «Tutorial».
- > Select the desired topic to get information.

4.2 Calling up the Creative Consultant

The Creative Consultant provides information about decision support concerning sewing projects. After entering the fabric and the desired sewing project, suggestions for suitable needles, presser feet etc. are displayed.



- > Touch the icon «Creative Consultant».
- > Select the fabric to be sewn.
- > Select the sewing project.

4.3 Calling up the Embroidery Consultant

The Embroidery Consultant provides information about decision support concerning embroidery projects. After entering the desired embroidery project and the fabric, suggestions for the suitable needle and the suitable embroidery foot are displayed.



- > Touch the icon «Embroidery Consultant».
- > Select the embroidery project.
- > Select the fabric which is to be embroidered.
- > Touch the icon «Confirm».
- If the embroidery motif has already been selected, a warning appears that it will be overwritten.

4.4 Calling up the Help



- > Touch the window in the display where help is needed.
- > Touch the icon «Help» to start the help mode.
- > Touch the icon in the display where help is needed.
- Assistance concerning the selected icon is displayed.

4.5 Using eco mode

During a longer interruption of work the machine can be set into a power save mode. The power save mode also serves as a child safety feature. Nothing can be selected in the display and the machine cannot be started.



- > Touch the icon «eco».
- The display goes to sleep. The power consumption is reduced and the sewing light is off.
- > Touch the icon «eco» again.
- The machine is ready for use.

4.6 Cancelling any alterations with «clr»

Any alterations to motifs can be reset to default setting. Exceptions are saved motifs which have been filed in the personal memory and monitoring functions.



- > Touch the icon «clr».

5 Creative sewing

5.1 Overview selection menu sewing



- | | | | |
|---|---------------------|---|-----------------|
| 1 | Practical stitches | 5 | Quilt stitches |
| 2 | Decorative stitches | 6 | Personal Memory |
| 3 | Alphabets | 7 | History |
| 4 | Buttonholes | | |

Selecting a stitch pattern

- > Select stitch pattern, alphabet or a buttonhole.
- > Touch the icon «Scrolling» to have more stitch patterns displayed.
- > Touch the icon «Display all the stitch patterns» (1) to scale up the view.
- > Touch the icon «Display all the stitch patterns» (1) again to downsize the stitch pattern view.



- > Touch the icon «Stitch pattern number entry» to select the stitch pattern via entering the stitch number.

5.2 BERNINA Dual Feed



It is recommended to match the presser foot pressure with the fabric. The thicker the fabric, the lower the presser foot pressure.

The BERNINA Dual Feed feeds the fabric from above and from beneath simultaneously. This provides an even and careful feed forward even for smooth and thin materials. Striped and checkered patterns can be matched perfectly by even feeding.

In general, the BERNINA Dual Feed is used for the following sewing projects:

- Sewing: All sewing applications with difficult fabrics such as for seams, zippers.

- > Hold the dual feed by the handle with two fingers, pull it down and then push it away from you and let it slide slowly upwards.



5.3 Regulating the speed

The sewing speed can be adjusted infinitely variable with the slide.

- > Move the slide to the left to reduce the sewing speed.
- > Move the slide to the right to increase the sewing speed.

5.4 Adjusting the upper thread tension

The basic setting of the upper thread tension is provided automatically as soon as a stitch pattern or an embroidery motif is selected.

The upper thread tension is set optimally at the BERNINA factory and the machine has been tested. Metrosene-/Seralon thread size 100/2 (Company Mettler, Switzerland) is used for upper and bobbin thread.

When of using other types of sewing or embroidery threads, the optimal tension may vary. Therefore it may be necessary to adjust the upper thread tension according to the sewing or embroidering project as well as the desired stitch pattern or the embroidery motif individually.

The higher the upper thread tension, the tighter the upper thread which means that the bobbin thread is pulled up to the top of the fabric. When the upper thread tension is low, the upper thread is less tightened which means that the bobbin thread is pulled up less.

Alterations of the upper thread tension affect the currently selected stitch pattern or embroidery motif. Permanent alterations of the upper thread tension for the sewing mode (see page 57) and for the embroidering mode (see page 62) can be made in the Setup Program.

Prerequisite:

- In the Setup Program the upper thread tension has been altered.
- > Touch the icon «Upper thread tension».



- > Move the slide using the touchscreen pen/finger to increase or reduce the upper thread tension.



- > Touch the yellow-framed icon on the right side to reset the alteration to default setting.
- > Touch the yellow-framed icon on the left side to reset the alteration to default setting in the **Setup Program**.

5.5 Editing stitch patterns

Changing the stitch width

- > Turn the «Upper Multifunction knob» to the left to narrow the stitch width.
- > Turn the «Upper Multifunction knob» to the right to widen the stitch width.
- > To call up further setting options, touch the icon «Stitch width» (1).



Changing the stitch length

- > Turn the «Lower Multifunction knob» to the left to shorten the stitch length.
- > Turn the «Lower Multifunction knob» to the right to elongate the stitch length.
- > To call up further setting options, touch the icon «Stitch length» (1).



Correcting the balance

Different fabrics, threads and stabilizers can affect the programmed stitch patterns so that they cannot be sewn out correctly. The electronic balance can correct these deviation and the stitch pattern can be adjusted optimally to the selected fabric.

- > Select a stitch pattern or alphabet.
- > Touch the icon «i»-Dialog.



- > Touch the icon «Balance».
- A preview of the stitch pattern is displayed.

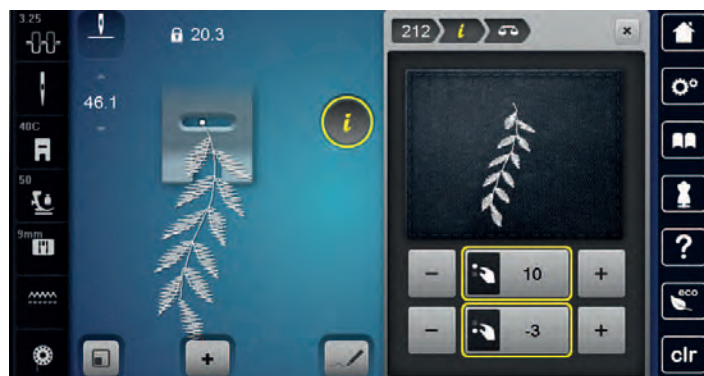

- > Turn the «Upper Multifunction knob» to correct the horizontal direction of the stitch pattern.
- > To correct the vertical direction of the stitch pattern, turn the «Lower Multifunction knob» until the preview of the stitch pattern is in accordance with the sewn stitch on the fabric.
- > To save the alterations, close the preview window or touch the icon «i»-Dialog.

Programming pattern repeat

Stitch patterns as well as stitch pattern combination can be repeated up to 9 times.

- > Select a stitch pattern or alphabet.
- > Touch the icon «i»-Dialog.



- > Touch the icon «Pattern repeat» once to sew the stitch pattern once.
- > Touch the icon «Pattern repeat» 2 to 9 times to repeat the stitch pattern up to 9 times.
- > Keep the icon «Pattern repeat» touched to deactivate the stitch pattern repeat.

Programming long stitch

The maximum length for long stitches is 12 mm and the machine sews every second stitch.

- > Select a stitch pattern.
- > Touch the icon «i»-Dialog.

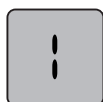

- > Touch the icon «Long stitch».

Mirror image of stitch patterns

- > Select a stitch pattern or alphabet.
- > Touch the icon «i»-Dialog.



- > Touch the icon «Mirror image left/right» to mirror the stitch pattern from left to right.



- > Touch the icon «Mirror image up/down» to mirror the stitch pattern contrary to the sewing direction.



Editing stitch pattern length

The stitch patterns can be lengthwise extended or shortened.

- > Select a stitch pattern or alphabet.
- > Touch the icon «i»-Dialog.



- > Touch the icon «Editing stitch pattern length».
- > Move the slide with the touchscreen pen/finger to determine the length of the stitch pattern.
- > Touch the icon «+100%» (1) to extend the stitch pattern length in 100%-steps.



Programming the stitch counter function

The stitch counter function cannot be applied with all stitch patterns. If, for example, the honeycomb stitch has been selected, the stitch counter function cannot be used.

- > Select a stitch pattern.
- > Touch the icon «i»-Dialog.



- > Touch the icon «Program the length with the stitch counter».
- > Sew the desired length.



- > Push the button «Quick reverse».
 - The display changes to «Auto» and the selected stitch pattern in the new length is saved until the machine is switched off.

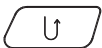

Quick reverse

- > Select a stitch pattern, alphabet or buttonhole.
- > Program needle stop down (permanent) to switch immediately to Quick reverse as soon as the button «Quick reverse» is pressed.
- > Program needle stop up (permanent) to sew another stitch forward before the machine switches to reverse sewing.

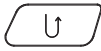

- > Push the button «Quick reverse» and keep pressed.

Permanent Quick reverse

- > Select a stitch pattern or alphabet.
- > Touch the icon «i»-Dialog.

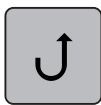

- > Touch the icon «Permanent reverse sewing» to sew permanently in reverse.
 - The machine keeps sewing in reverse until the icon «Permanent reverse sewing» is touched again.

Backstepping

- > Select a stitch pattern or alphabet.
- > Touch the icon «i»-Dialog.



- > Touch the icon «Backstepping» to backstep the last 200 stitches.

Changing the sewing direction

- > Select a stitch pattern or alphabet.
- > Touch the icon «i»-Dialog.



- > Touch the icon «Change the sewing direction».
- > Rotate the stitch pattern in 0.5°-steps using the «Upper Multifunctional knob» or the «Lower Multifunctional knob».
- > In the right portion of the display the stitch pattern can be rotated in 45°-steps (1) when touching the icons «Direct selection».



- > Touch the yellow-framed icon to reset any alterations to default setting.
 - In the left portion of the display the start of the stitch pattern is marked with a white dot (2).



5.6 Combining stitch patterns

Overview Combi mode



- | | | | |
|---|---|---|--|
| 1 | Matching the stitch pattern size with the display | 3 | Edit mode/Extended edit mode |
| 2 | Combi mode/Single mode | 4 | Individual stitch pattern within a combination |

Overview Combi mode extended

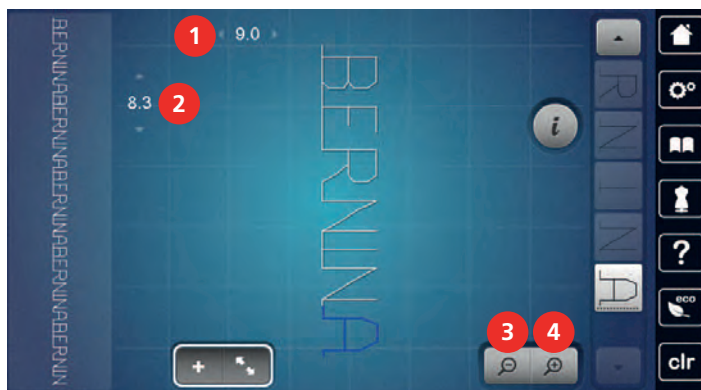

- | | | | |
|---|--|---|----------|
| 1 | Stitch width of the active stitch pattern | 3 | Zoom out |
| 2 | Stitch length of the active stitch pattern | 4 | Zoom in |

Creating Stitch pattern combinations

In the Combi mode stitch patterns and alphabets can be combined according to your wish. By combining any alphabet letters, the logo BERNINA can be created.



- > Touch the icon «Single/Combi mode».
- > Select the desired stitch patterns.



- > Touch the icon «Single/Combi mode» again to return to the single mode.

Saving a stitch pattern combination

- > Create a stitch pattern combination.
- > Touch the icon «Personal memory».



- > Touch the icon «Save stitch pattern».



- > Touch the icon «Confirm» or the yellow-framed icon to save the stitch pattern combination.



Loading a stitch pattern combination



- > Touch the icon «Single/Combi mode».

- > Touch the icon «Personal memory».



- > > Touch the icon «Selection of stitch pattern combination».
- > Select a stitch pattern combination.



Overwriting a stitch pattern combination

- > Create a stitch pattern combination.
- > Touch the icon «Personal memory».



- > Touch the icon «Save stitch pattern».
- > Select the stitch pattern combination which is to be overwritten.



- > Touch the icon «Confirm» to overwrite the stitch pattern combination.



Deleting a stitch pattern combination

- > Create a stitch pattern combination.
- > Touch the icon «i»-Dialog.



- > Touch the icon «Edit the complete combination».



- > Touch the icon «Delete».



- > Touch the icon «Confirm».



Editing the view of the stitch pattern combination

- > Create a stitch pattern combination.

- > Touch the icon «Edit mode».



- > Touch the icon «Zoom out» to downsize the view of the stitch combination.



- > Touch the icon «Zoom in» for a close up view of the downsized stitch pattern combination.



- > Touch the icon «Edit mode» to return to the Combi mode.



Editing a single stitch pattern

- > Create a stitch pattern combination.

- > With the touchscreen pen/finger touch the desired position (1) within the stitch pattern combination to select a single stitch pattern.



- > Touch the icon «i»-Dialog to edit the single stitch pattern.



Deleting a single stitch pattern

- > Create a stitch pattern combination.
- > With the touchscreen pen/finger touch the desired position (1) within the stitch pattern combination to select a single stitch pattern.



- > Touch the icon «i»-Dialog.



- > Touch the icon «Delete» or touch the desired stitch pattern with the touchscreen pen/finger, keep it touched and move it to the right.

or

- > touch the desired stitch pattern with the touchscreen pen/finger, keep it touched and move it outwards.
 - The stitch pattern is deleted.



Relocating a single stitch pattern

The connecting stitches between the stitch patterns are added automatically.



- > Create a stitch pattern combination.
- > Touch the icon «Edit mode».
- > With the touchscreen pen/finger select the desired position within the stitch pattern combination.
- > Touch the icon «i»-Dialog.

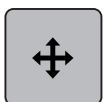

- > Touch the icon «Move the stitch pattern».
- > Move the stitch pattern with the touchscreen pen/finger.
- > Touch the yellow-framed icons to reset the alterations to default setting.

Adding a single stitch pattern

The new stitch pattern is always inserted **after** the selected stitch pattern.

- > Create a stitch pattern combination.
- > With the touchscreen pen/finger touch the desired position (1) within the stitch pattern combination to select a single stitch pattern.



- > Select a new stitch pattern.

Aligning the stitch length and width

The length and width of all the stitch patterns in a stitch pattern combination can be aligned with the longest and the widest stitch pattern. Moreover the length and the width of a stitch pattern combination can be enlarged or reduced proportionally.

- > Create a stitch pattern combination.
- > Touch the icon «i»-Dialog.



- > Touch the icon «Edit the complete combination».
- > Touch the icon «Stitch length of the current stitch pattern» (1).
- > Touch the icon «Adjust the length within a combination» (2).



- > Touch the icon «Stitch width of the current stitch pattern» (3).

- > Touch the icon «Adjust the width within a combination» (4).



- > Turn the «Upper Multifunctional knob» to the left to reduce the width of the stitch pattern combination proportionally.
- > Turn the «Upper Multifunctional knob» to the right to enlarge the width of the stitch pattern combination proportionally.
- > Turn the «Lower Multifunctional knob» to the left to reduce the length of the stitch pattern combination proportionally.
- > Turn the «Lower Multifunctional knob» to the right to enlarge the length of the stitch pattern combination proportionally.

Mirroring a stitch pattern combination

- > Create a stitch pattern combination.
- > Touch the icon «i»-Dialog.



- > Touch the icon «Edit the complete combination».

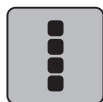

- > Touch the icon «Mirror image left/right» to mirror the whole stitch pattern combination from the left to the right.



- > Touch the icon «Mirror image left/right» again to reset the alterations to default setting.

Stitch pattern combination Subdivider 1

A stitch pattern combination can be subdivided into several sections. The subdivision is placed **beneath** the cursor. Only this section is sewn where the cursor is placed. To sew the next section, the cursor must be placed in the next section.

- > Create a stitch pattern combination.
- > With the touchscreen pen/finger select the desired position within the stitch pattern combination where the stitch pattern combination is to be subdivided.
- > Touch the icon «i»-Dialog.



- > Touch the icon «Edit combination at cursor position».

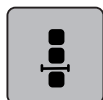

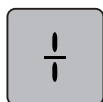

- > Touch the icon «Combination subdivider».

Stitch pattern combination Subdivider 2

A stitch pattern combination can be interrupted at several positions. The interruption is placed **beneath** the cursor.

- > Create a stitch pattern combination.
- > With the touchscreen pen/finger select the desired position within the stitch pattern combination where the stitch pattern combination is to be interrupted.
- > Touch the icon «i»-Dialog.

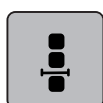

- > Touch the icon «Edit combination at cursor position».

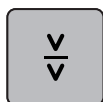

- > Touch the icon «Combination subdivider 2».
- > Sew the first section and then reposition the fabric.

Securing a stitch pattern combination

- > Create a stitch pattern combination.
- > With the touchscreen pen/finger select the desired position within the stitch pattern combination where the stitch pattern combination is to be secured.
- > Touch the icon «i»-Dialog.

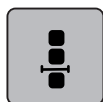

- > Touch the icon «Edit combination at cursor position».



- > Touch the icon «Securing».
 - Every single pattern of the stitch pattern combination can be secured at the start or at the end.

Relocating several stitch patterns

- > Create a stitch pattern combination.
- > Touch the icon «Overview combination».
- > With the touchscreen pen/finger select the first stitch pattern of the stitch pattern combination.
- > Touch the icon «i»-Dialog.

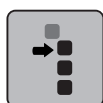

- > Touch the icon «Move single patterns or sections of a combination».
- > With the touchscreen pen/finger move the section of the stitch pattern combination to any direction.
- > Touch the yellow-framed icons to reset the alterations to default setting.

Programming pattern repeat



- > Create a stitch pattern combination.
- > Touch the icon «i»-Dialog.



- > Touch the icon «Edit the complete combination».



- > Touch the icon «Pattern repeat» once to repeat the stitch pattern combination.
- > Touch the icon «Pattern repeat» again to repeat the stitch pattern combination up to 9 times.
- > To deactivate the pattern repeat, keep the icon «Pattern repeat» pressed or touch the icon «clr».

Changing the sewing direction of a stitch pattern



- > Create a stitch pattern combination.
- > Touch the icon «Overview combination».
- > With the touchscreen pen/finger select the stitch pattern within the stitch pattern combination.
- > Touch the icon «i»-Dialog.



- > Touch the icon «Change the sewing direction».
- > Turn the «Upper Multifunctional knob» or the «Lower Multifunctional knob» to rotate the stitch pattern in 0.5°- steps.
- > Touch the yellow-framed icon to reset the alteration to default setting.

Changing the sewing direction of a stitch pattern combination



- > Create a stitch pattern combination.
- > Touch the icon «Overview combination».



- > Touch the icon «i»-Dialog.



- > Touch the icon «Edit the complete combination».



- > Touch the icon «Change the sewing direction».
- > Turn the «Upper Multifunctional knob» or the «Lower Multifunctional knob» to rotate the stitch pattern in 0.5°- steps.
- > Touch the yellow-framed icon to reset the alteration to default setting.

5.7 Administering stitch patterns

Saving settings of stitch patterns



- > Select a stitch pattern, alphabet or buttonhole.
- > Touch the icon «i»-Dialog.
- > Edit the stitch, alphabet or buttonhole.

- > Touch the icon «Load embroidery motif».
- > Select the file where the stitch pattern has been saved.
- > Select a stitch pattern.

Deleting stitch patterns from the personal memory

Prerequisite:

- The stitch pattern is saved in the personal memory.



- > Touch the icon «Personal memory».



- > Touch the icon «Delete».
- > Select the file where the stitch pattern has been saved.
- > Select a stitch pattern.



- > Touch the icon «Confirm» to delete the stitch pattern.

Saving stitch patterns on the BERNINA USB stick

On the BERNINA USB stick stitch patterns, also those which have been individually edited, can be saved.

- > Select a stitch pattern, alphabet or buttonhole.
- > Edit the stitch pattern.



- > Touch the icon «Personal memory».



- > Touch the icon «Save stitch pattern».
- > Insert the BERNINA USB stick into the USB port of the machine.



- > Touch the icon «USB Stick».



- > Touch the icon «Confirm».

Uploading a stitch pattern from the BERNINA USB stick



- > Touch the icon «Personal memory».



- > Touch the icon «Load stitch pattern».
- > Touch the icon (1).



- > Insert the BERNINA USB stick into the USB port of the machine.

- > Touch the icon «USB stick».
- > Select the desired stitch pattern.

Deleting stitch patterns from the BERNINA USB stick



- > Touch the icon «Personal memory».



- > Touch the icon «Delete».
- > Insert the BERNINA USB stick into the USB port of the machine.
- > Select the stitch pattern which is to be deleted.



- > Touch the icon «Confirm».

5.8 Stitch Designer

Overview Stitch Designer



- | | | | |
|---|---------------------|----|------------------------------------|
| 1 | Back | 7 | Limiting pattern width |
| 2 | Redo | 8 | Moving the view |
| 3 | Point position | 9 | Relocating points/Selecting points |
| 4 | Zoom out | 10 | Inserting/Editing a stitch |
| 5 | Zoom in | 11 | Scrolling through points |
| 6 | Stitch pattern view | | |

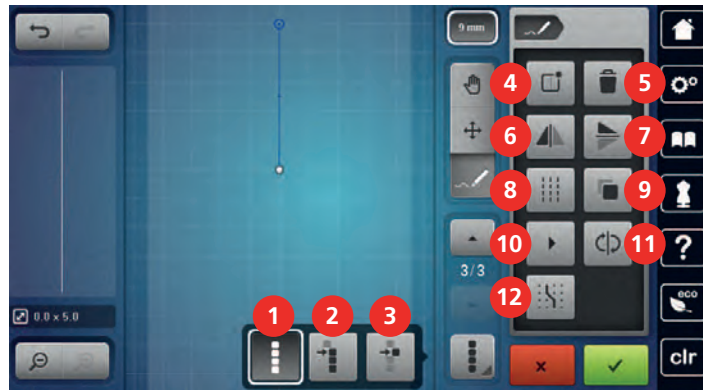

- | | | | |
|---|-----------------------------------|----|-------------------------------|
| 1 | Select all points | 7 | Mirror image up/down |
| 2 | Selecting from a particular point | 8 | Triple stitch |
| 3 | Single point is selected | 9 | Duplicating |
| 4 | Creating a new stitch pattern | 10 | Virtual sewing out |
| 5 | Deleting | 11 | Reversing the stitch sequence |
| 6 | Mirror image left/right | 12 | Engaging at the grid |

Creating your own stitch pattern



The stitch patterns which have been created in the Stitch Designer can be saved in your «Personal memory».

The Stitch Designer allows creating your personal stitch patterns as well as editing existing stitch patterns. By moving the touchscreen pen/finger, your personal stitch patterns can be created on the display.

In the left portion of the display the position of the currently active point is indicated additionally. The horizontal distance of the point to the center line is indicated in millimeters. The vertical distance of the point to the previous point is also indicated in millimeters.



> Touch the icon «Stitch Designer».



- > Touch the icon «Creating a new stitch pattern».
- > Add a point on the display with the touchscreen pen/finger.
- > Add more points on the display as desired.



> Touch the icon «Confirm».

Editing the view

> Select a stitch pattern, alphabet or buttonhole.

> Touch the icon «Stitch Designer».

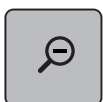

> Touch the icon «Zoom out» to minimize the view of the stitch pattern.



> Touch the icon «Zoom in» to enlarge the downsized stitch pattern view.



- > Touch the icon «Move the view».
- > Move the view of the stitch pattern using the touchscreen pen/finger.

Inserting points



- > Select a stitch pattern, alphabet or buttonhole.
- > Touch the icon «Stitch Designer».



- > Touch the icon «Engaging at the grid» to have the grid points displayed.
 - Every inserted point is automatically placed on the nearest grid point.



- > Touch the icon «Scroll up» to select the point after which a new point is to be inserted.



- > Touch the icon «Scroll down» to select the point to select the point after which a new point is to be inserted.



- > Add more points with the touchscreen pen/finger.



- > Touch the icon «Undo» to undo the last work step.



- > Touch the icon «Redo» to restore the last work step.

Relocating the points



- > Select a stitch pattern, alphabet or buttonhole.
- > Touch the icon «Stitch Designer».

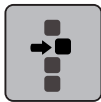

- > Touch the icon «Single point is selected».



- > Touch the icon «Select from a particular point».



- > Touch the icon «Scroll up» to add the previous point to the selection.



- > Touch the icon «Scroll down» to add the following point to the selection.
- > Turn the «Upper Multifunctional knob» to move the selected points horizontally.
- > Turn the «Lower Multifunctional knob» to move the selected points vertically.

Duplicating points



- > Select a stitch pattern, alphabet or buttonhole.
- > Touch the icon «Stitch Designer».

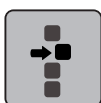

- > Touch the icon «Single point is selected».



> Touch the icon «Select from a particular point».



> Touch the icon «Scroll up» to add the previous point to the selection.



> Touch the icon «Scroll down» to add the following point to the selection.



> Touch the icon «Duplicate».

Deleting points



> Select a stitch pattern, alphabet or buttonhole.

> Touch the icon «Stitch Designer».

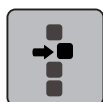

> Touch the icon «Single point is selected».



> Touch the icon «Select from a particular point».



> Touch the icon «Scroll up» to add the previous point to the selection.



> Touch the icon «Scroll down» to add the following point to the selection.



> Touch the icon «Delete» to delete all the selected points of the stitch pattern.

Activating the triple stitch



> Select a stitch pattern, alphabet or buttonhole.

> Touch the icon «Stitch Designer».



> Touch the icon «Select from a particular point».



> Touch the icon «Scroll up» to select the previous point.



> Touch the icon «Scroll down» to select the following point.



> Touch the icon «Triple stitch» to activate the triple stitch for the selected points.



Mirror image of stitch patterns

- > Select a stitch pattern, alphabet or buttonhole.
- > Touch the icon «Stitch Designer».



- > Touch the icon «Single point is selected».

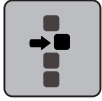

- > Touch the icon «Select all points».



- > Touch the icon «Mirror image stitch pattern left/right» to mirror all the points horizontally.



- > Touch the icon «Mirror image stitch pattern up/down» to mirror all the points vertically.



Reversing the stitch sequence

- > Select a stitch pattern, alphabet or buttonhole.
- > Touch the icon «Stitch Designer».



- > Touch the icon «Single point is selected».

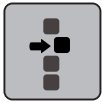

- > Touch the icon «Select all points».



- > Touch the icon «Reversing the stitch sequence».

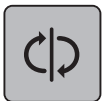

Designing a stitch pattern from scratch

- > Select a stitch pattern, alphabet or buttonhole.
- > Touch the icon «Stitch Designer».



- > Touch the icon «Virtual sewing out».



Determining the stitch pattern width

The width of the stitch pattern is limited to 9 mm. To sew wider patterns, for example sideways motion pattern, it is necessary to deactivate the limit.

- > Select a stitch pattern, alphabet or buttonhole.
- > Touch the icon «Stitch Designer».



9 mm

- > Touch the icon «Limiting pattern width» to deactivate the limit.
- > Touch the icon «Limiting pattern width» again to activate the limit.

5.9 Securing

Securing a seam with the button «Securing»

The button «Securing» can be programmed with various securing stitches.



- > Push the button «Securing» before starting to sew.
 - The stitch pattern/stitch pattern combination will be secured with the number of programmed stitches when sewing is started.
- > Press the «Securing» while sewing.
 - The machine stops immediately and secures with the number of programmed stitches.

Securing with the button «Pattern end»

The button «Pattern end» can be programmed with various functions.



- > Push the button «Pattern end» before sewing is started or while sewing.
 - While sewing, a stop icon indicates that the function is activated and the stitch pattern or the current combination of a stitch pattern will be secured at the end with the programmed number of stitches.

5.10 Height Compensation of uneven layers

If the presser foot is at an angle when sewing over a thick seam, the feed dog cannot grip the fabric and the sewing project cannot be sewn out properly.

- > Place 1 – 3 compensating plates as required from the back of the presser foot close to the needle to level the fabric layer.

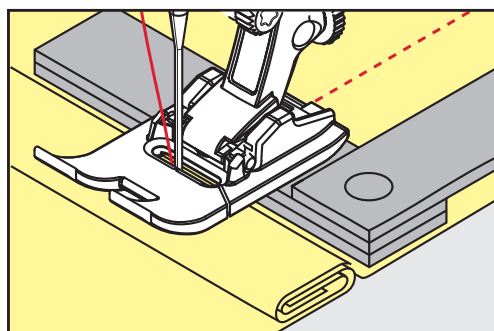

- The presser foot is leveled with the sewing project.

- > Place 1 – 3 compensating plates as required from the front of the presser foot close to the needle to level the fabric layer.

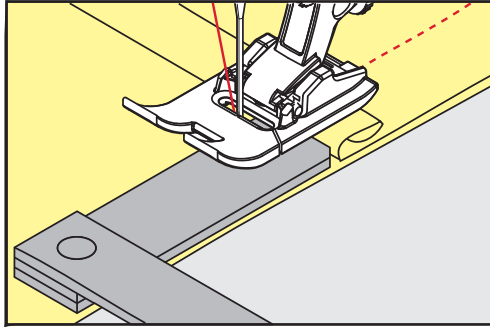

- The presser foot is leveled with the sewing project.
- > Sew until the complete presser foot has passed the thick seam.
- > Remove the plates of the height compensation.

5.11 Sewing Corners

When sewing corners, only a small section of the fabric is actually on the feed dog. Therefore it cannot grip the fabric well. By means of the height compensation tool the fabric can be fed evenly.

- > When the fabric edge is reached, stop the sewing process with needle position down.
- > Raise the presser foot.
- > Turn the fabric and place in desired position.
- > Place 1 – 3 compensating plates as required on the right of the presser foot close to the sewing project.
- > Lower the presser foot.

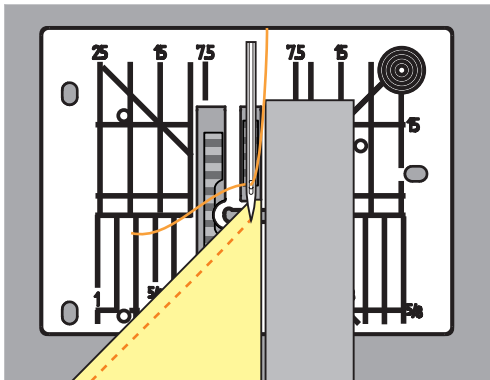

















- > Resume sewing until the sewing project is on the feed dog again.





6 Practical stitches

6.1 Overview Practical stitches



Stitch patterns	Stitch number	Name	Description
	1	Straight stitch	Seams and topstitching.
	2	Zig zag	Reinforcing seams, overcasting edges, sewing elastic seams and attaching lace.
	3	Vari overlock	Sewing and finishing in one step of elastic fabrics.
	4	Running stitch	Darning with running stitch, mending fabrics, reinforcing edges.
	5	Securing Program	Securing starts and ends of seams by straight stitching.
	6	Triple Straight stitch	Reinforced seams in heavy fabrics; visible hems and seams.
	7	Triple Zig zag	Reinforced seams in heavy fabrics; visible hems and seams.
	8	Honeycomb stitch	For elastic fabrics and hems. Is also used with elastic bobbin threads.
	9	Blindstitch	Blind hems, shell edging effect on soft jerseys and fine material, decorative seams.
	10	Double overlock	Sewing and finishing in one step of elastic fabrics.
	11	Superstretchstitch	For highly stretch fabrics. For all types of clothing.

Stitch patterns	Stitch number	Name	Description
	12	Gathering stitch	Most types of fabric; gathering with shirring elastic, butted seams = butting two pressed edges and sewing together, decorative stitches.
	13	Stretch overlock	Sewing and finishing in one step of elastic fabrics.
	14	Tricot stitch	Visible hems, visible seams in lingerie, sweaters, mending jersey.
	15	Universal stitch	For firm fabrics such as felt and leather. Flat joining seams, visible seams, attaching elastic, decorative seams.
	16	Sewn-out Zig zag	Edge finishing and reinforcing, attaching elastic, decorative seam.
	17	Lycra stitch	For lycra fabrics; flat joining seams and hems, reinforced seaming on underwear.
	18	Stretch stitch	For highly stretch fabrics; open seam for sportswear.
	19	Reinforced overlock	For medium-weight knitware and toweling; overlock seams, flat joining seams.
	20	Knit overlock	Sewing and finishing in one step of hand and machine knitted fabrics.
	21	Basting stitch	For seams and hems.
	22	Simple Darning Program	Darning of holes and damaged fabric.
	23	Reinforced Darning Program	Reinforcing darning holes and damaged fabric.
	24	Bartack Program	Reinforcing pocket openings, sewing belt loops.
	25	Bartack Program	Reinforcing pocket openings, sewing on belt loops, securing zippers and seam ends.
	26	Large Fly stitch	Reinforcing pocket openings, zippers and slits in medium-weight to thick fabrics.
	27	Small Fly stitch	Reinforcing pocket openings, zippers and slits in fine or medium-weight fabrics.

Stitch patterns	Stitch number	Name	Description
	29	Narrow blindstitch	For blind hems in fine fabrics.
	31	Triple Straight stitch with long stitch	Reinforced seams in heavy fabrics; visible hems and seams.
	32	Single Straight stitch	Used as a connecting stitch in a combination.
	33	Three Single Straight stitches	As connecting stitches in a combination.
	34	Darning stitch	For darning.

6.2 Sewing straight stitch

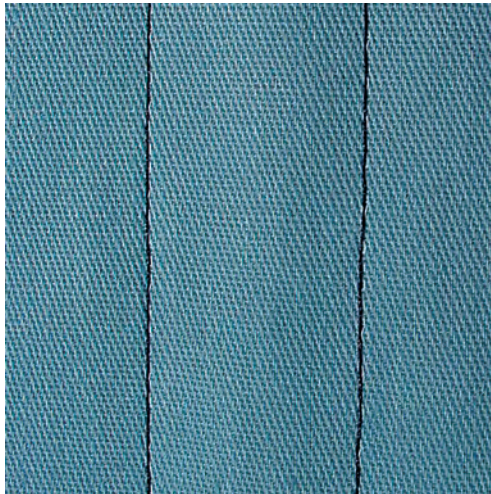

Match the stitch length with the sewing project, which means for denim fabrics long stitches (ca. 3 – 4 mm), for fine fabrics short stitches (ca. 2 – 2.5 mm). Match the stitch length with the thread size, e.g. long stitches when topstitching with Cordonnet (ca. 3 – 5 mm).

Prerequisite:

- The Reverse pattern foot No.1C/1D is attached.



- > Touch the icon «Practical stitches».
- > Select the Straight stitch No. 1.

6.3 Securing with the automatic Securing Program

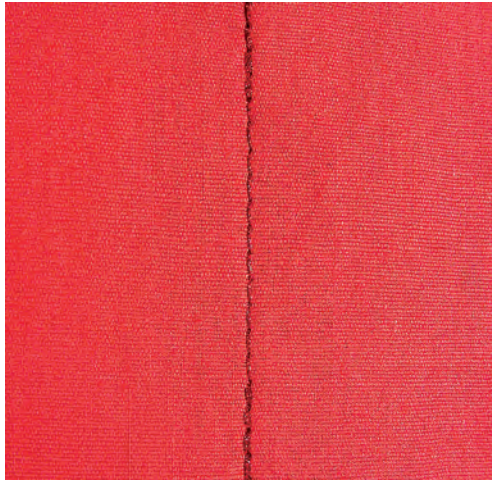

Due to a determined number of 5 stitches sewn forward and 5 stitches sewn backward, the securing is regular.

Prerequisite:

- The Reverse pattern foot No. 1C is attached.



- > Touch the icon «Practical stitches».
- > Select the Securing Program No. 5.
- > Press the foot control.
 - The machine secures automatically.

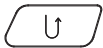

- > Sew the seam in the desired length.
- > Push the button «Quick reverse».
 - The machine secures automatically and stops at the end of the securing program.

6.4 Sewing in the zipper

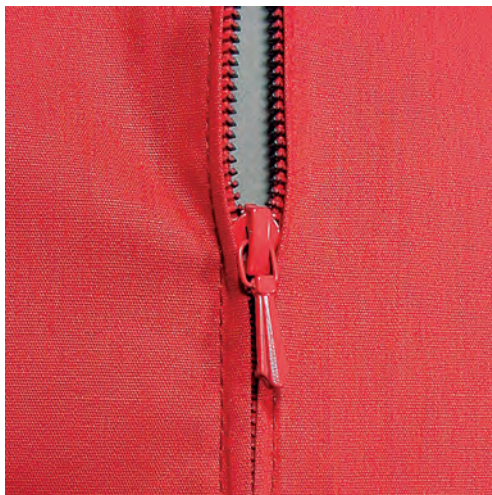

As the fabric feed can be difficult when starting to sew, it is recommended to hold the threads firmly or to pull the fabric slightly to the back for a few stitches or to sew 1 – 2 cm reverse first.

- > Attach the Reverse pattern foot No. 1C.



- > Touch the icon «Practical stitches».
- > Select the Straight stitch No. 1.
- > Sew the seam up to where the zipper starts.
- > Sew the securing stitches.
- > Close the zipper length with long stitches.
- > Finish the seam allowances.
- > Iron the seam.
- > Open the zipper length.
- > Baste the zipper under the fabric so that the fabric folded edges meet over the center of the zipper.
- > Open the zipper a few centimeters.
- > Attach the Zipper foot No. 4D.
- > Move the needle position to the right.
- > Use the Free Hand System to raise the presser foot and to position the sewing project.
- > Start sewing from top left.
- > Guide the foot so that the needle stitches along the zipper coils.
- > Stop in front of the zipper pull with needle position down.
- > Raise the presser foot.
- > Close the zipper.
- > Continue to sew and stop in front of the base of the zipper with needle position down.
- > Raise the presser foot and turn the sewing project.
- > Sew across the other side of the zipper and stop with needle position down.
- > Raise the presser foot and turn the sewing project.
- > Sew the second side from bottom to top.

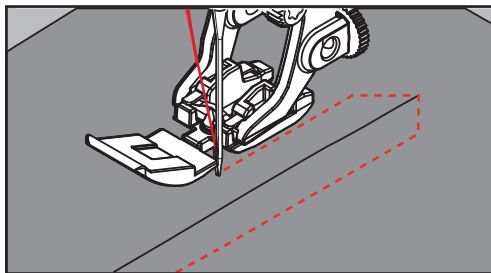

6.5 Sewing both sides of the zipper from bottom to top

For fabrics with pile, such as velvet, it is recommended to sew in the zipper on both sides from bottom to top.



When the fabric is densely woven or hard, it is recommended to use a needle with the size 90 – 100. This results in an even stitch formation.



- > Attach the Reverse pattern foot No. 1C.
- > Touch the icon «Practical stitches».
- > Select the Straight stitch No. 1.
- > Sew the seam up to where the zipper starts.
- > Sew the securing stitches.
- > Close the zipper length with long stitches.
- > Finish the seam allowances.
- > Iron the seam.
- > Open the zipper length.
- > Baste the zipper under the fabric so that the fabric folded edges meet over the center of the zipper.
- > Attach the Zipper foot No. 4D.
- > Move the needle position to the right.
- > Use the Free Hand System to raise the presser foot and to position the sewing project.

- > Start sewing in the center of the seam at the end of the zipper.
- > Sew diagonally along the edge of the zipper coils.
- > Sew the first side (1) from bottom to top.
- > Stop in front of the zipper pull with needle position down.
- > Raise the presser foot.
- > Open the zipper as far as behind the presser foot.
- > Lower the presser foot and continue sewing.
- > Sew the second side (2) in exactly the same way from bottom to top.

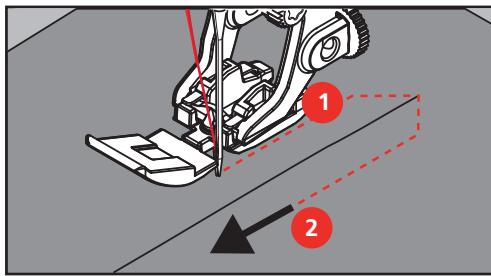

6.6 Sewing Triple straight stitch



The triple straight stitch is especially suitable for durable seams and for firm, densely woven fabrics such as denim and corduroy. For firm or densely woven materials it is recommended to attach the Jeans foot No. 8. This will help to sew denim or canvas. For decorative topstitching the stitch length can be elongated.

- > Attach the Reverse pattern foot No. 1C/1D.
- > Touch the icon «Practical stitches».
- > Select the Triple straight stitch No. 6.



6.7 Sewing Triple zig zag

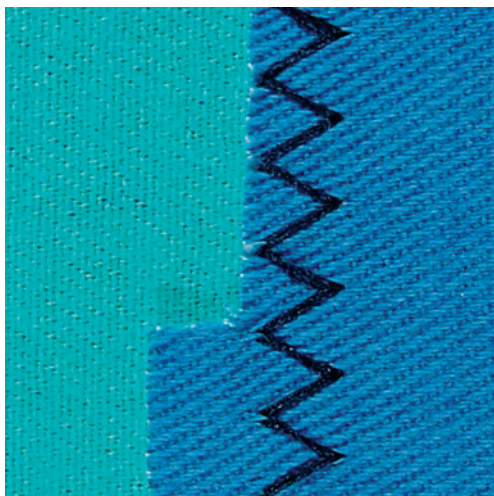

For firm materials such as denim, deckchair covers, awnings or frequently washed items. Finish raw edges first.



- > Attach the Reverse pattern foot No. 1C/1D.
- > Touch the icon «Practical stitches».
- > Select the Triple zig zag No. 7.

6.8 Manual darning

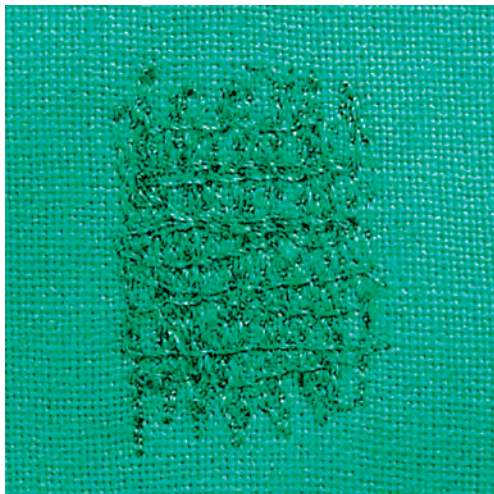

Used for darning holes or worn areas in all fabric types.

If the thread is lying on top and a poor stitch formation results, slow down the movement of the sewing project. If there are knots on the wrong side of the fabric, move the sewing project faster. When the thread breaks, guide the sewing project more consistently.



- > Attach the Darning foot No. 9 (optional accessory).
- > Touch the icon «Practical stitches».
- > Select the Straight stitch No. 1.
- > Lower the feed dog.
- > Attach the slide-on table.
- > Hoop the sewing project in the round embroidery hoop (optional accessory).
 - The area to be darned stays evenly taut and cannot be distorted.

- > Sew from the left to the right, guide the fabric evenly by hand without using pressure.
- > Move in curves when changing the direction to avoid holes and thread breakage.
- > Work the rows in irregular lengths so that the thread is better spread over the fabric.

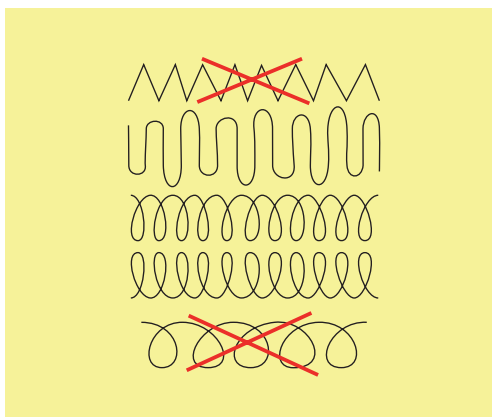

- > Sew the first rows not too close together and beyond the worn area.
- > Sew the rows in irregular lengths.

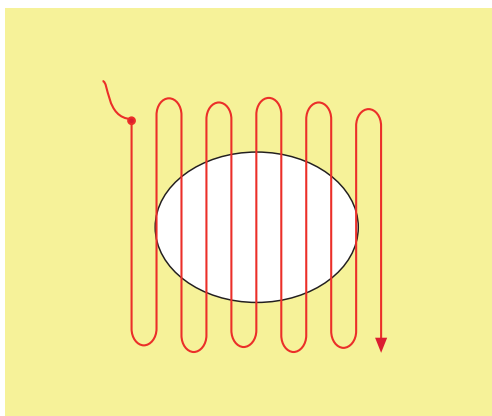

- > Turn the sewing project by 90°.
- > Sew the first rows not too close.

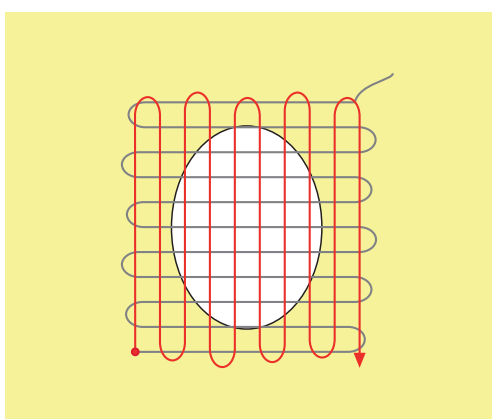

- > Turn the sewing project by 180°.

- > Sew another loose row.

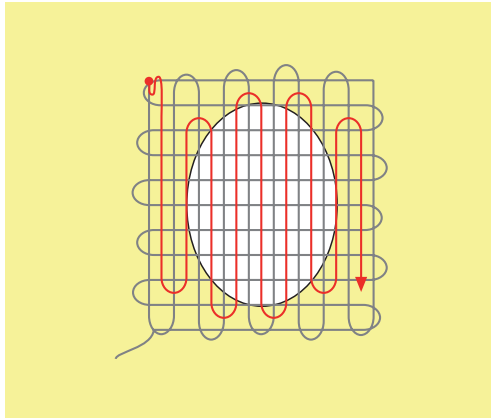

6.9 Automatic darning



The simple Darning Program No. 22 is especially suitable for quick darning of worn or damaged areas. It is recommended to use fine material as a backing for the worn and damaged areas or to stick an adhesive interlining. The simple Darning Program No. 22 replaces threads along the lengthwise grain in all materials. If the darning area becomes distorted, correct with the balance.

- > Attach the Reverse pattern foot No. 1C or the Buttonhole foot No. 3A.
- > Touch the icon «Practical stitches».
- > Select the simple Darning Program No. 22.
- > Hoop light-weight materials in the round embroidery hoop (optional accessory).
 - The darning area stays evenly taut and cannot be distorted.
- > Start sewing top left.
- > Sew the first row.
- > Stop the machine.
- > Push the button «Quick reverse».
 - The length is programmed.
- > Finish sewing the Darning Program.
 - The machine stops automatically.



- > Guide the edge of the fabric into the center of the presser foot, so that the needle goes into the fabric on one side and over the edge into the air on the other side.

6.13 Sewing Double overlock

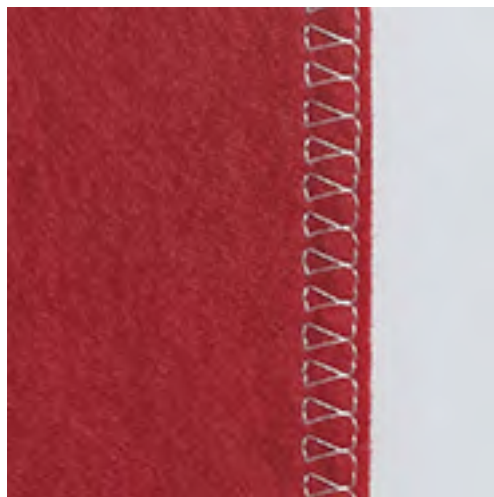

A double overlock seam is suitable for loose knits and cross seams in knits. When working with jersey, a jersey needle should be used to prevent damaging the knit fabric. When sewing stretch materials, use a stretch needle.

- > Attach the Reverse pattern foot No. 1C or the Overlock foot No. 2A.
- > Touch the icon «Practical stitches».
- > Select the Double overlock No. 10.



6.14 Narrow edgestitching

- > Attach the Blindstitch foot No. 5 or the Reverse pattern foot No. 1C or the Edge stitch foot No. 10/10C/10D (optional accessory).
- > Touch the icon «Practical stitches».
- > Select the Straight stitch No. 1.
- > Place the edge on the left against the guide of the Blindstitch foot.
- > Select the needle position left at the desired distance to the edge.

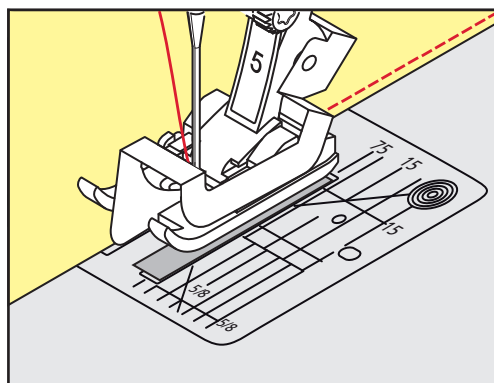

6.15 Wide edgestitching

- > Attach the Blindstitch foot No. 5 or the Reverse pattern foot No. 1C or the Edge stitch foot No. 10/10C/10D (optional accessory).
- > Touch the icon «Practical stitches».
- > Select the Straight stitch No. 1.
- > Guide the edge along the presser foot or at a distance of 1 – 2.5 cm (0.39 – 0.98 inch) along the marks.
- > Select the needle position in the desired distance to the edge.

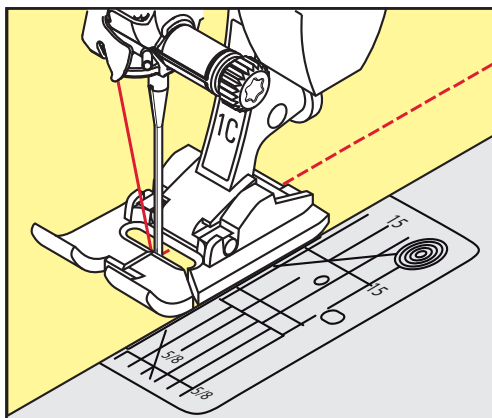

6.16 Edgestitching using the seam guide

When sewing parallel wider lines, it is recommended to guide the seam guide along the sewn of lines.

- > Attach the Reverse pattern foot No. 1C or the Edge stitch foot No. 10/10C/10D (optional accessory).
- > Touch the icon «Practical stitches».
- > Select the Straight stitch No. 1.
- > Loosen the screw on the back of the presser foot.
- > Insert the seam guide into the hole of the presser foot.
- > Adjust the width as desired.
- > Tighten the screw.
- > Guide the folded edge along the seam guide.

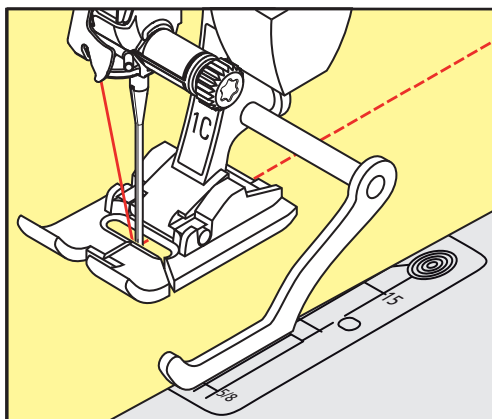

6.17 Sewing hem edges

When using the Blindstitch foot No. 5, it is recommended to select a needle position far left or far right. When using the Reverse pattern foot No. 1C or the Edge stitch foot No. 10/10C/10D all needle positions are possible.

- > Attach the Blindstitch foot No. 5 or the Reverse pattern foot No. 1C or the Edge stitch foot No. 10/10C/10D (optional accessory).



- > Touch the icon «Practical stitches».
- > Select the Straight stitch No. 1.
- > Place the inside upper edge right against the guide of the Blindstitch foot.
- > Select the needle position far right to sew along the upper edge.

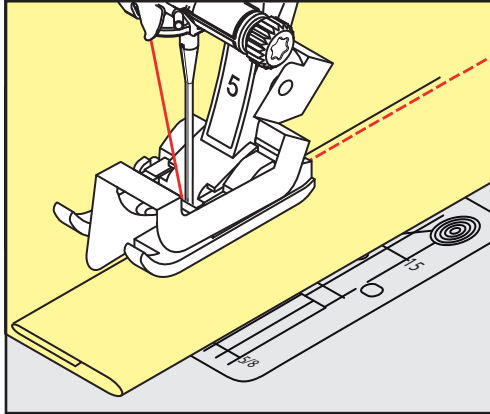

6.18 Sewing blind hems

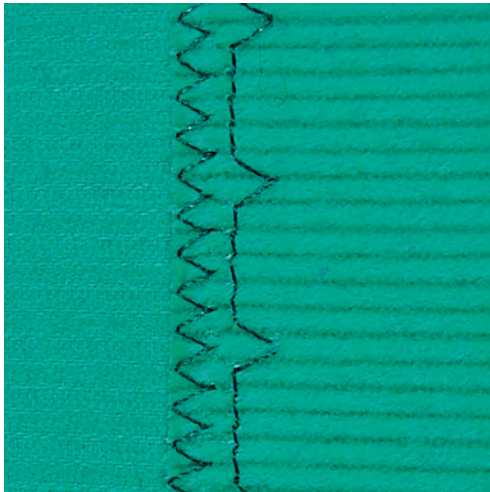

For invisible hems in medium to heavy-weight cotton, wool and blended materials.

Prerequisite:

- The fabric edges are finished.



- > Attach the Blindstitch foot No. 5.
- > Touch the icon «Practical stitches».
- > Select the Blindstitch No. 9.
- > Fold the fabric back over the right side of the fabric to expose the finished lower edge.
- > Place the fabric under the presser foot and move the folded edge against the metal guide on the presser foot.
- > Guide the folded edge evenly along the metal guide of the foot to sew the stitches evenly deep.
 - Make sure that the needle only pierces the edge of the fold.

- > After sewing about 10 cm (ca. 3.93 inch) check both sides of the fabric and adjust the width again if necessary.

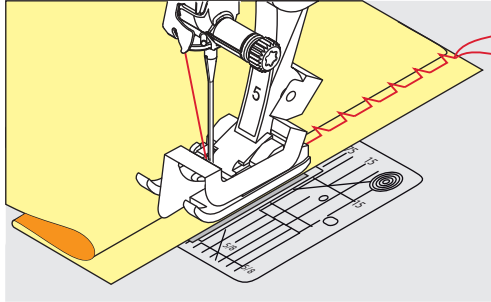

6.19 Sewing visible hems



The visible hem is especially suitable for elastic hems in jersey, cotton, wool, synthetic and mixed fibers.



- > Attach the Reverse pattern foot No. 1C/1D.
- > Touch the icon «Practical stitches».
- > Select Tricot stitch No. 14.
- > Iron the hem and baste if necessary.
- > Reduce the presser foot pressure if necessary.
- > Sew the hem at the preferred depth on the right side.
- > Trim the excess fabric from the wrong side.

6.20 Sewing flat joining seams

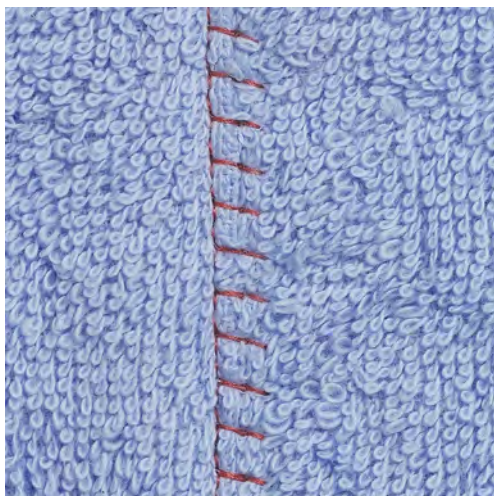

The flat joining seam is especially suitable for or thick materials such as terry cloth, felt and leather.



- > Attach the Reverse pattern foot No. 1C.
- > Touch the icon «Practical stitches».
- > Select the Stretch overlock No. 13.
- > Overlap the fabric edges.
- > Sew along the fabric edge.
- > The needle stitches over the edge of the top layer on the right side into the bottom layer to get a very flat durable seam.

6.21 Sewing basting stitches

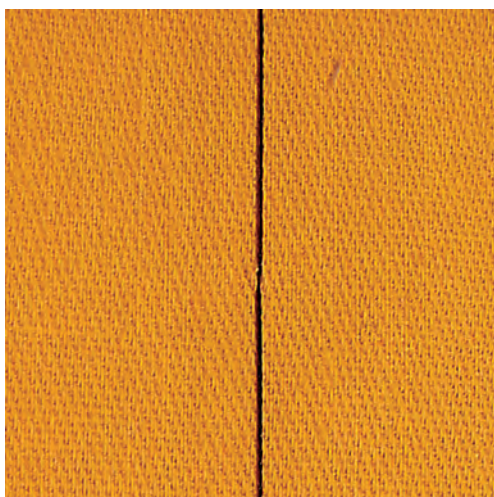

When sewing basting stitches, it is recommended to use a fine darning thread as this is easier to remove. With the Basting stitch No. 21 only every fourth stitch is sewn. The longest stitch possible is 24 mm when the stitch length is set at 6 mm. The recommended stitch length is 3.5 – 5 mm. The basting stitch is suitable for sewing projects where a very long stitch length is required.



- > Attach the Reverse pattern foot No. 1C/1D.
- > Touch the icon «Practical stitches».
- > Select the Basting stitch No. 21.
- > Select the stitch length.
- > Pin the fabric layers at a right angle to basting direction to prevent the layers from slipping.
- > Sew 3 – 4 basting stitches at the beginning and at the end.

7 Decorative stitches







7.1 Overview Decorative Stitches

Depending on the type of material, simple or more complex decorative stitches should be selected to best suit the material.

- Decorative stitches which are programmed with simple straight stitches are particularly appropriate for light-weight materials, e.g. the Decorative stitch No. 101.
- Decorative stitches which are programmed with triple straight stitches or with a few satin stitches are particularly appropriate for medium-weight materials, e.g. Decorative stitch No. 107.
- Decorative stitches which are programmed with satin stitches are particularly appropriate for heavy-weight materials, e.g. Decorative stitch No. 401.

For a perfect stitch formation it is of advantage to use the same thread color for upper and bobbin thread and a stabilizer. With pile or longfiber materials it is recommended to use an additional, water-soluble stabilizer on the right side which can be easily removed after sewing.



Decorative stitch	Category	Name
	Category 100	Natural stitches
	Category 200	Natural stitches sideways motion
	Category 300	Cross stitches
	Category 400	Satin stitches
	Category 500	Satin stitches sideways motion
	Category 600	Ornamental stitches
	Category 700	Heirloom stitches
	Category 800	Heirloom sideways motion

Decorative stitch	Category	Name
	Category 900	Novelty
	Category 1000	Novelty sideways motion
	Category 1200	Filigree Stitches sideways motion
	Category 1400	Tapering
	Category 1500	Skyline Stitches (special stitches)
	Category 1600	Quilt stitches sideways motion
	Category 1700	International

7.2 Bobbin-Play



The bobbin can be filled with different thread material. For free-motion stitching to add texture. This method is similar to «normal» free-motion sewing, but is done on the **wrong** side of the fabric.

Reinforce the area to be sewn with embroidery stabilizer. The design can be drawn on the wrong side of the fabric. You can also draw the design on the front side of the fabric. The lines can be followed with a freely guided straight stitch using polyester, cotton or rayon thread. The rows of stitching are visible on the right side of the fabric, and serve as reference lines for the bobbin-thread sewing.

The BSR function can be used for bobbin-thread sewing. It is recommended to guide your project at consistent speed evenly under the needle, following the lines of the design. The stabilizer must be removed after sewing.

Sew a sample first to check what the result looks like on the wrong side of the fabric.

Not all decorative stitches are suitable for this technique. Simple decorative stitches provide best results. Avoid compact stitch types and satin stitches.

NOTICE

Inappropriate bobbin case is used

Damage of the bobbin case.

> Use the Bobbinwork bobbin (optional accessory).

> Attach the Embroidery foot No. 20C or No. 20D (optional accessory).



> Touch the icon «Decorative stitches».

> Select an appropriate decorative stitch.

> Turn the «Upper Multifunctional knob» and the «Lower Multifunctional knob» to adjust the stitch length and the stitch width so that even when sewing with thick thread a nice stitch formation can be achieved.



> Touch the icon «i»-Dialog.

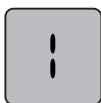

> Touch the icon «Long stitch» so that the stitch pattern is sewn less densely.



> Touch the icon «Upper thread tension» to adjust the upper thread tension if necessary.

7.3 Altering the stitch density

With certain decorative stitches (e. g. No. 401) the stitch density can be altered. If the stitch density is increased, the stitch distance is enlarged. If the stitch density is decreased, the stitch distance is shortened. The programmed length of the stitch pattern is not affected.

> Select the decorative stitch.

> Touch the icon «i»-Dialog.



> Touch the icon «Edit pattern length/stitch density».

> Adjust the stitch density via the icons (1) «-» or «+».



7.4 Tapering

Overview Tapering



- | | | | |
|---|-------------------------|----|------------------------------------|
| 1 | Programming length | 6 | Determining the length manually |
| 2 | Pattern repeat | 7 | Selecting kind of tapering |
| 3 | Adjusting the length | 8 | Backstepping |
| 4 | Mirror image left/right | 9 | Saving settings of stitch patterns |
| 5 | Balance | 10 | Back to default setting |

Altering points of a stitch pattern

Tapering is a technique in which the stitch patterns come to a point at the beginning and the end. Four different points are pre-programmed. In addition to that, the points of stitch patterns can also be determined manually.



- > Touch the icon «Decorative stitches».
- > Select a stitch pattern of the Kategorie 1400.



- > Touch the icon «i»-Dialog.



- > Touch the icon «Select type of tapering».
- > Select the desired point of the stitch pattern in the right portion of the display.



man

- > Touch the icon «Determine the length manually» to adjust the points of the stitch pattern individually.
- > Touch the icons «-» or «+» in the upper right portion of the display to alter the points of the stitch pattern.
- > Touch the icons «-» or «+» in the lower right portion of the display to alter the length of the stitch pattern points.



Sewing tapering

Alterations of the selected stitch pattern are saved automatically. In the manual mode alterations are canceled when the stitch pattern is selected again.



- > Touch the icon «Decorative stitches».
- > Select a stitch pattern of the Kategorie 1400.



- > Touch the icon «i»-Dialog.

man

- > Touch the icon «Determining the length manually» so that the alterations of the stitch pattern are not saved.

mm REC

- > Touch the icon «Program the tapering length» to save the alterations of the stitch pattern automatically.



- > Push the button «Start/Stop» or the foot control to start sewing.



U

- > Push the button «Quick reverse» as soon as the desired length in the center section of the tapering is reached.
 - The machine sews the whole stitch pattern and stops automatically.

Sewing tapering automatically



- > Touch the icon «Decorative stitches».
- > Select a stitch pattern of the Catégorie 1400.



- > Touch the icon «i»-Dialog.



- > Touch the icon «Determining length».
- > Turn the «Upper Multifunctional knob» or the «Lower Multifunctional knob» to determine the length.



- > Push the button «Start/Stop» or the foot control to start sewing.
 - The machine sews the whole stitch pattern and stops automatically.

7.5 Sewing cross stitches

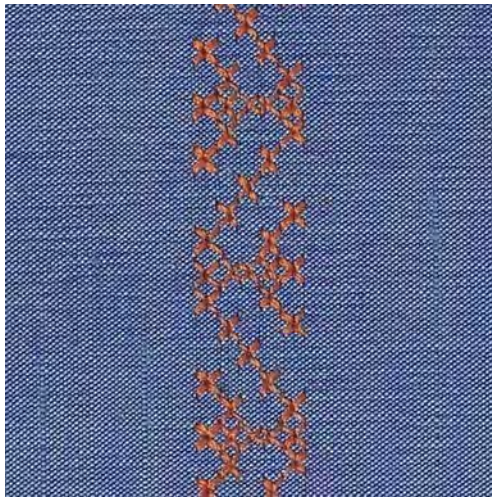

Cross stitching is a traditional technique, and extends the range of decorative stitches. If the cross stitches are sewn on fabric with a linen texture, they look like hand-stitched cross stitching. When cross stitches are sewn with cotton embroidery thread, the stitch pattern appears fuller. Cross stitches are particularly used for home furnishing, trimmings on garments and embellishing in general. As every following line refers to the first row, it is important to stitch the first row in a straight line.

- > Attach the Reverse pattern foot No. 1C/1D or the Open Embroidery foot No. 20C or the Embroidery foot No. 20D (optional accessory).
- > Select a cross stitch of the Catégorie 300 and combine it as desired.
- > Stitch the first row using the seam guide or slide-on table seam guide to sew a straight line.
- > Stitch the second row next to the first at a distance of one presser foot's width or using the seam guide.





7.6 Pintucks

Pintucks

The technique reduces the size of the fabric piece. It is always advisable to plan in sufficient fabric. Pintucks are narrow stitched folds, which are normally sewn on the fabric before cutting out the pieces for the garment or the sewing project. They are suitable for embellishing or in combination with other heirloom embroidery techniques.

A more distinctive and relief-like effect can be achieved when the pintucks are corded, which means that they are sewn with an additional pintuck cord. Choose a pintuck cord that fits well into the grooves of the selected pintuck foot. The cord must be colorfast and shrink-proof.

Overview pintucks

Pintuck foot	Number	Description
	# 30 (optional accessory)	3 grooves For heavy-weight fabrics. In combination with the 4 mm double needle
	# 31 (optional accessory)	5 grooves For heavy to medium-weight fabrics. In combination with the 3 mm double needle
	# 32 (optional accessory)	7 grooves For light to medium-weight fabrics. In combination with the 2 mm double needle
	# 33 (optional accessory)	9 grooves For very light fabrics (without pintuck cord). In combination with the 1 or 1.6 mm double needle
	# 46C (optional accessory)	5 grooves In combination with the 1.6 – 2.5 mm double needle For very light to medium-weight fabrics.

8 Alphabets and Monograms

8.1 Overview Alphabets

Block, Double block, Script and Comic alphabets as well as as Cyrillic can be sewn in two different sizes. Monograms can be sewn in three different sizes. Block, Double block, Script and Comic alphabets as well as as Cyrillic can also be sewn in lower case letters.

For a perfect stitch formation use the same thread color for upper and bobbin threads. The fabric can be reinforced with embroidery stabilizer on the wrong side. When working with pile or napped fabrics, e.g. toweling, use an additional, water-soluble stabilizer on the right side of the fabric.



Stitch patterns	Name
ABCabc	Block alphabet
ABCabc	Double-Block
<i>ABCabc</i>	Script (Italics)
ABCabc	Comic Sans
АБВабв	Cyrillic
あいう	Hiragana
アイウ	Katakana
<i>ABC</i>	Monograms 30/20/15 mm

8.2 Creating lettering



When sewing sideways motion pattern, for example monograms, it is recommended to use the Sideways motion foot No. 40C. Sewing a test sample with the thread, the actual fabric and stabilizer you intend to use is recommended. Make sure that the fabric is fed evenly and lightly, ensuring that it cannot push against or catch on anything. The fabric shouldn't be pulled, pushed or held back.



- > Touch the icon «Alphabets».
- > Select the font.



- > Touch the icon «Single/Combi mode» to create a combination.
- > Touch the icon «Display alphabets» (1) to open an extended enter mode.



- > Select the letters.
- > Touch the icon (2) (standard setting) to use upper case letters.
- > Touch the icon (3) to use lower case letters.
- > Touch the icon (4) to use numbers.
- > Touch the icon (5) to use special characters and mathematical symbols.



- > Touch the icon «DEL» to delete single letters of the entered text.
- > Touch the icon «Display alphabets» again to close the extended enter mode.

8.3 Altering font size

Block, Double block, Script and Comic alphabets as well as Cyrillic can be reduced.



- > Touch the icon «Alphabets».
- > Select the font.
- > Select the letters.



> Touch the icon «i»-Dialog.



> Touch the icon «Altering font size» to reduce the font size.

> Touch the icon «Altering font size» again to scale up the font size up to 9 mm.

8.4 Altering size of monogram

The font size 30 mm is pre-programmed. The letters can be reduced to 20 mm or 15 mm.

Prerequisite:

- A single letter is selected.



> Touch the icon «i»-Dialog.



> Touch the icon «Altering size of monogram» to reduce the lettering to 20 mm.

> Touch the icon «Altering size of monogram» again to reduce the lettering 15 mm.

> Touch the icon «Altering size of monogram» again to scale up the lettering to 30 mm.









9 Buttonholes

9.1 Overview Buttonholes

To create the correct buttonhole for every button, every purpose and for every garment, your BERNINA 790 PLUS is equipped with a considerable collection of buttonholes. The corresponding button can be sewn on automatically. Eyelets can also be sewn.



Buttonhole	Buttonhole number	Name	Description
	51	Standard buttonhole	For light to medium-weight fabrics; blouses, dresses, bedlinens.
	52	Standard buttonhole narrow	For light to medium-weight fabrics; blouses, dresses, children's and baby clothes, crafts.
	53	Stretch buttonhole	For any highly elastic jersey made from cotton, wool, silk and synthetic fibers.
	54	Round buttonhole with normal bartack	For medium to heavy-weight fabrics: dresses, jackets, coats, rainwear.
	55	Round Buttonhole with horizontal bartack	For medium to heavy-weight fabrics: dresses, jackets, coats, rainwear.
	56	Keyhole buttonhole	For heavy-weight, non-stretch fabrics; jackets, coats, leisure wear.
	57	Keyhole buttonhole with pointed bartack	For firm, non-stretch fabrics: jackets, coats, leisure wear.
	58	Keyhole buttonhole with horizontal bartack	For firm, non-stretch fabrics: jackets, coats, leisure wear.
	59	Straight stitch buttonhole	Program for staystitching buttonholes, for pocket openings, reinforcing buttonholes, especially for buttonholes in leather and imitation leather.

Buttonhole	Buttonhole number	Name	Description
	63	Heirloom	For light to medium-weight woven fabrics; blouses, dresses, leisure wear, bedlinen.
	66	Buttonhole with double pointed bartack, narrow	Decorative buttonhole for medium-weight fabrics; blouses, dresses, jackets.
	68	Decorative Keyhole buttonhole with horizontal bartack	For firm, non-stretch fabrics: jackets, coats, leisure wear.
	69	Decorative buttonhole with double pointed bartack	For decorative buttonholes in firmer, non-elastic fabrics.
	60	Button sew-on program	For buttons with 2 and 4 holes.
	61	Eyelet with small zig zag	Openings for cords and narrow ribbons, for decorative work.
	62	Straight-stitch eyelet	Openings for cords and narrow ribbons, for decorative work.

9.2 Making use of the height compensation tool

When a buttonhole is to be sewn at right angles to the project edge, it is recommend to use the height compensation plates (optional accessory).

- > Place the plates from the back between the sewing project and the bottom of the slide to the thick part of the sewing project.

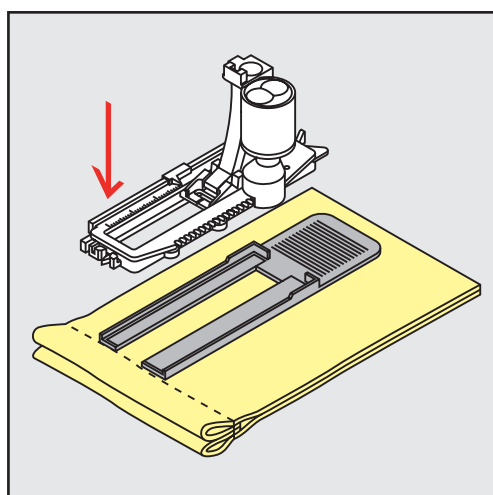

- > Lower the presser foot.

9.3 Using the compensation plate

When sewing a buttonhole in difficult materials, it is recommended to use the compensation plate for buttonholes (optional accessory). It can be used along with the Buttonhole foot No. 3A.

- > Insert the compensation plate carefully from the side.

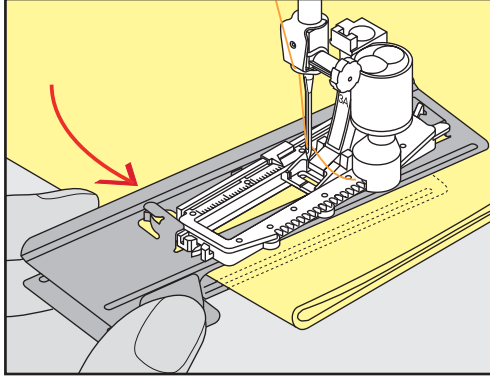

9.4 Marking buttonholes

- > For the buttonholes to be sewn manually, mark the position and the length on the fabric using chalk or a water-soluble pen.

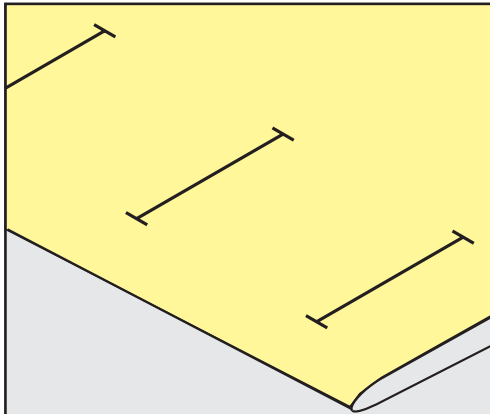

- > For the buttonholes to be sewn automatically, mark the complete length of 1 buttonhole on the fabric using chalk or a water-soluble pen. For any subsequent buttonholes mark the starting point.

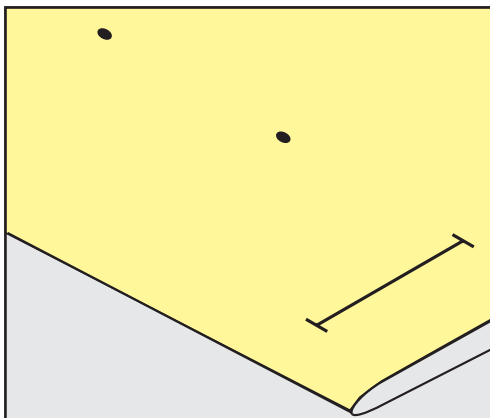

- > For keyhole and round buttonholes mark the length of the bead with chalk or a water-soluble pen on the fabric. For any subsequent buttonholes mark the starting point. The length of the keyhole is sewn additionally.

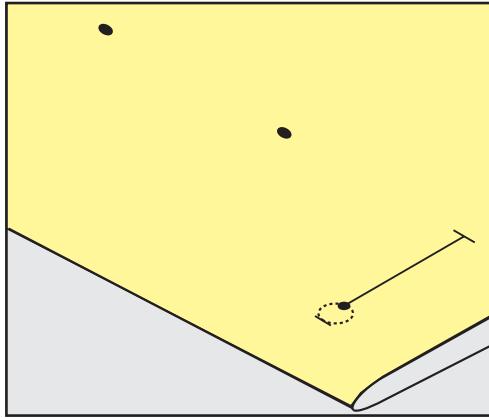

9.5 Cord

Using cord with the Buttonhole foot with slide No. 3A

Cords reinforce buttonholes and enhance their appearance and suit best for the Buttonhole No. 51. Ideal cords are Perle cotton No. 8, strong hand-sewing thread and fine crochet yarn. It is recommended to not hold the cord while sewing.

Prerequisite:

- The Buttonhole foot with slide No. 3A is attached and raised.
- > Insert the needle at the beginning of the buttonhole.
- > Guide the cord on the right side under the buttonhole foot.
- > Hook the cord over the pin at the back of the buttonhole foot.

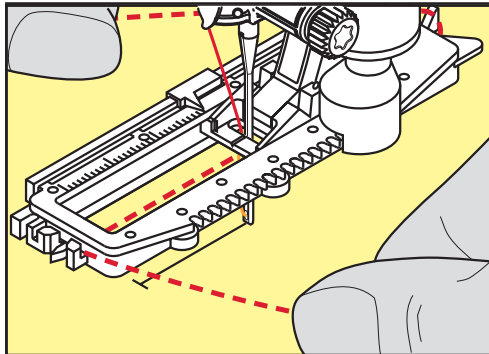

- > Pull the cord on the left side under the buttonhole foot to the front.

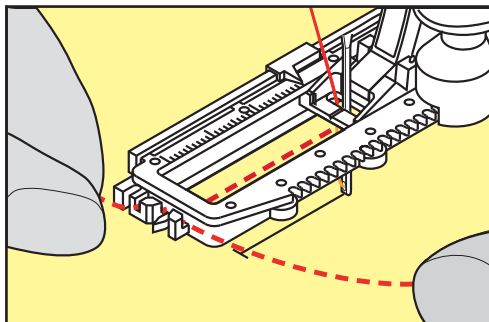

- > Pull the cord ends into the slits.
- > Lower the buttonhole foot.
- > Sew the buttonhole in the usual manner.
- > Pull the cord through the buttonhole until the loop disappears in the bartack.
- > Pull the ends of the cord through to the wrong side of the fabric (using a hand stitching-needle), knot or secure with stitches.

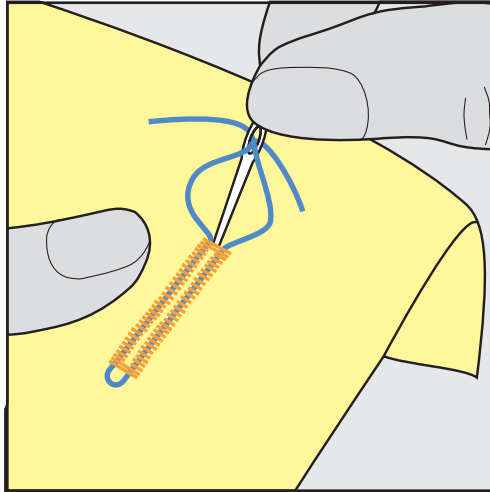

Using cord with the Buttonhole foot No. 3C (optional accessory)

Prerequisite:

- The Buttonhole foot No. 3 is attached and raised.
- > Insert the needle at the beginning of the buttonhole.
- > Hook the cord over the pin at the front of the buttonhole foot.

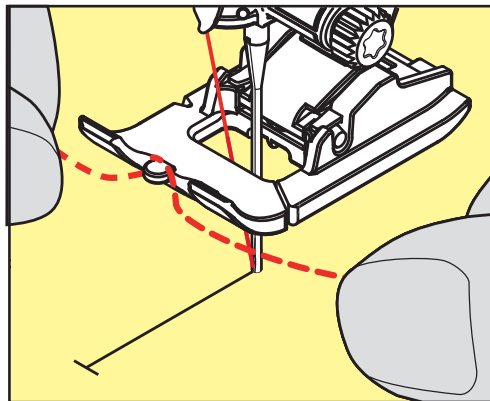

- > Pull both cords ends under the buttonhole foot to the back and place each a cord into a groove of the sole.

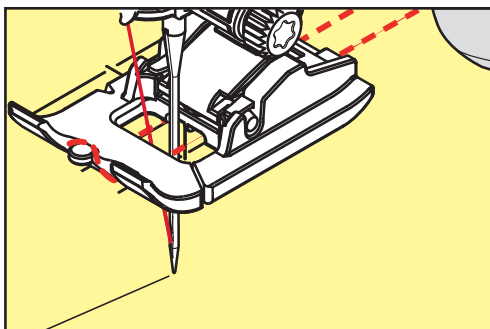

- > Lower the buttonhole foot.
- > Sew the buttonhole in the usual manner.
- > Pull the cord through the buttonhole until the loop disappears in the bartack.
- > Pull the ends of the cord through to the wrong side of the fabric using a hand stitching-needle and knot or secure with stitches.

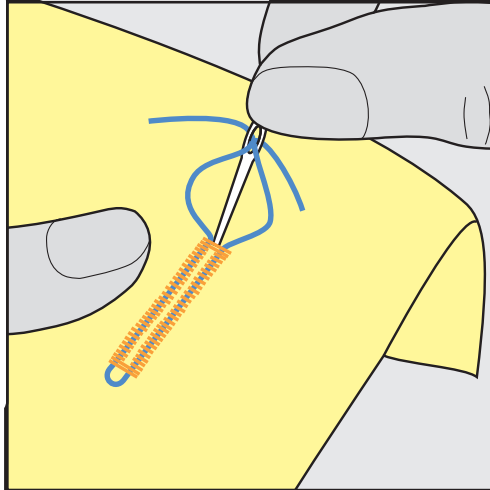

9.6 Sewing a test sample

Always sew a test sample of the buttonhole on the same fabric: It is recommended to use the same stabilizer and to select the same buttonhole. The test sample should also be sewn in the respective direction. By sewing a test sample the settings can be adjusted until the sewing result is satisfying.

When working with soft loosely woven materials or for buttonholes which are highly stressed, it is worth underlaying the buttonholes with the Straight stitch buttonhole No. 59. This is also recommended to reinforce buttonholes in leather, vinyl or felt.

Alterations of the balance when sewing a manual standard buttonhole as well as the keyhole and the round buttonhole affect both beads in the same way. With the manual keyhole or round buttonhole, the alterations affect both sides in the opposite way.

If the stitch counter function is used and alterations are made concerning the balance, the alterations affect both buttonhole beads differently.



- > Touch the icon «Buttonholes».
- > Select the buttonhole.
- > Select and attach the desired presser foot.
- > Place the fabric under the presser foot and lower the presser foot.
- > Press the foot control carefully and start sewing. Guide the fabric slightly.
- > Check the balance while sewing and adjust if necessary.
- > Check the test sample and make further amendments if necessary.

9.7 Determining the buttonhole slit width

The width of the buttonhole slit can be adjusted between 0.1 – 2.0 mm before sewing.



- > Touch the icon «Buttonholes».
- > Select the buttonhole.



- > Touch the icon «i»-Dialog.

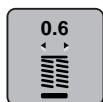

- > Touch the icon «Buttonhole slit width».
- > Turn the «Upper Multifunctional knob» or the «Lower Multifunctional knob» to adjust the buttonhole slit width as desired.

9.8 Determining the buttonhole length



The button can be centered in the yellow circle in the lower portion of the display. The yellow circle can be enlarged or downsized with the «Multifunctional knobs up/down» and the diameter of the button can be determined in this way.

Additionally to the diameter of the button, 2 mm are added automatically for the buttonhole length. If the diameter of the button is 14 mm, the buttonhole length is calculated 16 mm.

Prerequisite:

- The Buttonhole foot with slide No. 3A is attached.



- > Touch the icon «Buttonholes».
- > Select the buttonhole.



- > Touch the icon «i»-Dialog.

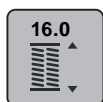

- > Touch the icon «Adjust the buttonhole length».
- > Turn the «Upper Multifunctional knob» or the «Lower Multifunctional knob» to adjust the buttonhole length.

9.9 Determining the buttonhole length with Buttonhole foot No. 3C (optional accessory)

With the Buttonhole foot No. 3C (optional accessory) the buttonhole length must be determined via the stitch counter function. The stitch counter function is suitable for all types of buttonholes. The left buttonhole bead is sewn forward, the right buttonhole bead is sewn in reverse. If alterations of the balance are made, the stitch counter function has to be saved for every buttonhole separately.

Prerequisite:

- The Buttonhole foot No. 3C (optional accessory) is attached.



- > Touch the icon «Buttonholes».
- > Select the buttonhole.



- > Touch the icon «i»-Dialog.



- > Touch the icon «Program the length with the stitch counter».
- > Sew the desired buttonhole length.
- > Stop the machine.

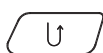

- > Push the button «Quick reverse» so that the machine sews the lower bartack and the second bead in reverse.
- > Stop the machine at the height of the first stitch.
- > Push the button «Quick Reverse» so that the machine sews the upper bartack and the securing stitches.
 - The length of the buttonhole remains saved and every subsequent buttonhole is sewn identically until the machine is switched off.

9.10 Sewing a buttonhole automatically

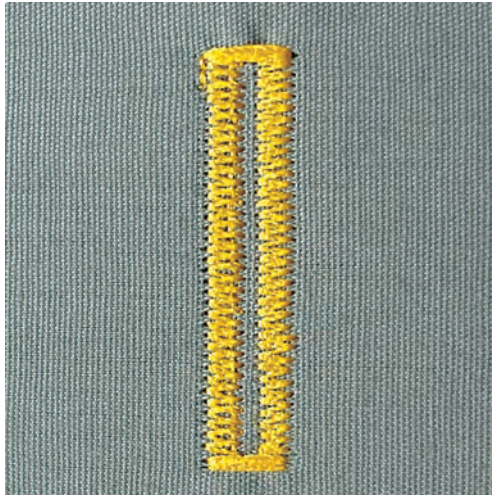

When the Buttonhole foot with slide No. 3A is used, the length of the buttonhole is measured automatically by the lens on the presser foot. The buttonhole will be duplicated and the machine switches to the next step automatically when the maximum length is reached. The Buttonhole foot with slide No. 3A is suitable for buttonholes in the length of 4 – 31 mm, depending on the buttonhole type. The slide of the Buttonhole foot must lie perfectly flat on the fabric so that the length can be measured accurately. All the programmed buttonholes are the same length and of the same nice look.

Prerequisite:

- The Buttonhole foot with slide No. 3A is attached.



- > Touch the icon «Buttonholes».
- > Select the Buttonhole No. 51 – 53 or 54 – 58 or No. 66, 68 or 69.
- > Sew the desired buttonhole length.

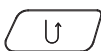

- > Push the button «Quick reverse» to program the length.



- > Push the button «Start/Stop» or the foot control.
 - The machine finishes the buttonhole automatically. All subsequent buttonholes are sewn at the same length.

9.11 Programming the Heirloom buttonhole

Prerequisite:

- The Buttonhole foot with slide No. 3A is attached.



- > Touch the icon «Buttonholes».
- > Select the Buttonhole No. 63.
- > Sew the desired buttonhole length.

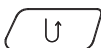

- > Push the button «Quick reverse» to program the length.
 - The machine finishes the buttonhole automatically. All subsequent buttonholes are sewn at the same length.

9.12 Sewing the manual 7-step buttonhole

The length of the beads is manually determined when sewing. Bartack, eye and securing stitches are preprogrammed. The individual steps can also be selected by scrolling, by using the arrow icons, by direct selection or by touching the button «Quick reverse».

Prerequisite:

- The Buttonhole foot No. 3C (optional accessory) is attached.



- > Touch the icon «Buttonholes».
- > Select the Buttonhole No. 51.



- > Touch the icon «i»-Dialog.



- > Touch the icon «Adjust the length manually».
 - Icon (1) in the display is activated for the buttonhole start.
- > Sew the desired buttonhole length.
 - The icon (2) is activated.



- > Stop the machine at desired length of the bead or to the end of the length marking.
- > Touch the icon (3).
- > Stop at the height of the first stitch at the start of the buttonhole.
- > Touch the icon (4).
 - The machine sews the upper bartack and stops automatically.
- > Touch the icon (5).
 - The machine sews the second bead.
- > Stop the machine at the height of the first bead.
- > Touch the icon (6).
 - The machine sews the bottom bartack and stops automatically.

- > Touch the icon «Scroll down» so that the last icon appears.
- > Touch the icon.
 - The machine secures and stops automatically.

9.13 Sewing the manual 5-step buttonhole

The length of the buttonhole is determined manually when sewing. Bartack, eye and securing stitches are preprogrammed. The individual steps can also be selected by scrolling, by using the arrow icons, by direct selection or by touching the button «Quick reverse».

Prerequisite:

- The Buttonhole foot No. 3C (optional accessory) is attached.



- > Touch the icon «Buttonholes».
- > Select the Buttonhole No. 54.



- > Touch the icon «i»-Dialog.



- > Touch the icon «Adjust the length manually».
 - Icon (1) in the display is activated for the buttonhole start.
- > Sew the desired buttonhole length.
 - Icon (2) is activated.



- > Stop sewing at the desired length of the bead or at the marking.
- > Touch the icon (3).
 - The machine sews the eye or the keyhole and stops automatically.
- > Touch the icon (4).
 - The machine sews the second bead in reverse. Stop the machine at the first stitch where the buttonhole starts.
- > Touch the icon (5).
 - The machine sews the upper bartack and secures automatically.

9.14 Cutting the buttonhole open with the seam ripper

- > Place a pin in each end of the buttonhole to avoid accidental cutting into ends of buttonhole.
- > Cut the buttonhole from both ends to the middle.

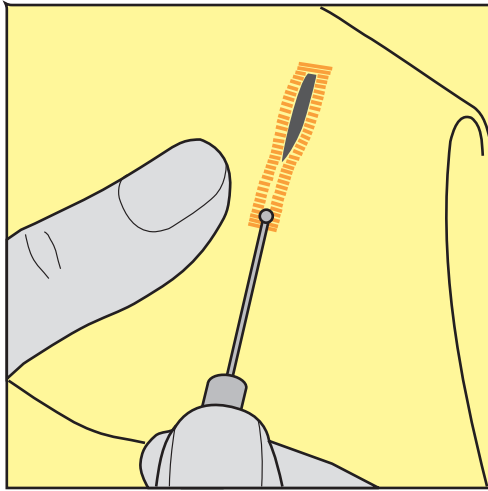

9.15 Cutting open buttonholes with the buttonhole cutter (optional accessory)

- > Place the fabric on an appropriate piece of wood.

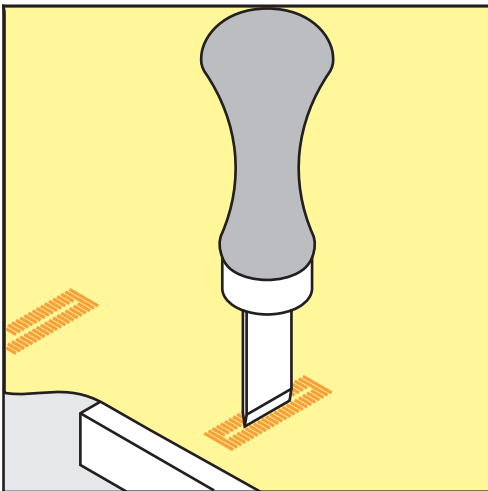

- > Position the cutter in the center of the buttonhole.
- > Press down on the cutter with your hand.

9.16 Sewing on buttons

With the Button sew-on program, buttons with 2 or 4 holes, snap buttons or snap fasteners can be sewn on.

Recommended sewing program: Button sewing-on program No. 60

Recommended presser foot : Button sew-on foot No. 18

Alternative presser feet:

- Reverse pattern foot No. 1 or 1C
- Darning foot No. 9
- Reverse pattern foot No. 34 or 34C

Adjusting the thread shank

For buttons on thicker fabrics, increase the thread shank = the distance between the button and the fabric. Buttons sewn on thin fabrics or buttons for decorative purposes only are stitched without a «thread shank».

NOTICE! The adjustment of the thread shank is only possible when using the Button sew-on foot No. 18.

- > Loosen the screw on the back of the presser foot.
- > Push the bar upwards according to the thickness of the fabric.
- > Tighten the screw.

Sewing on buttons

Prerequisite:

- The shank length is adjusted according the fabric thickness.
- The Button sew-on foot No. 18 or an alternative presser foot is attached.
- The attached presser foot has been selected in the user interface.
- The feed dog is lowered.



- > Touch the icon «Buttonholes».
- > Select the Button sew-on Program No. 60.
- > Turn the handwheel until the bobbin thread comes up.
- > **NOTICE! The Button sew-on program always starts above the left hole of the button.**
Position the button on the fabric. Place the button and the fabric beneath the needle so that the needle stitches into the left hole.
For buttons with 4 holes, sew the first front pair of holes first.
- > Lower the presser foot.
- > Perform the first stitches in the left hole via the handwheel.
- > Keep turning the handwheel until the needle changes to the right hole.
Make sure that the needle meets the right hole. If necessary, adjust the stitch width by turning the upper Multifunction knob.
- > Hold the threads and push the foot control.
 - The machine sews on the button and stops automatically.
- > For increased stability, sew the Button sew-on program again.
- > Cut the threads with the machine. Alternatively, pull the sewing projects from under the sewing machine and trim the threads by hand. Pull the upper thread to the wrong side of the fabric and knot it with the bobbin thread.

9.17 Sewing eyelets



For increased stability sew the eyelet twice.

Prerequisite:

- The Reverse pattern foot No. 1C or the Open embroidery foot No. 20C is attached.







- > Touch the icon «Buttonholes».
- > Select the Eyelet Program No. 61 or No. 62.
- > Turn the «Upper Multifunctional knob» or the «Lower Multifunctional knob» to alter the size of the eyelet.
- > Sew the Eyelet Program.
 - The machine stops automatically at the end of the Eyelet Program.
- > Use an awl, punch pliers or a hole punch to open the eyelet.

10 Quilting

10.1 Overview Quilt Stitches



Stitch patterns	Stitch number	Name	Description
	1324	Quilting, Securing Program	To secure at the sewing start and sewing end with short stitches forward.
	1325	Quilting straight stitch	Straight stitch at 3 mm stitch length.
	1326	Piecing stitch/Straight stitch	Straight stitch at 2 mm stitch length.
	1327	Stippling stitch	Imitation of stipple quilting.
	1328	Handlook quilt stitch	Imitation of handlook quilt stitch with monofilament.
	1329	Blanket stitch	For appliqué and sewing on ribbons.
	1330	Double blanket stitch	For appliqué and sewing on ribbons.
	1331	Blindstitch narrow	To sew blindstitches.
	1332	Feather stitch	For "Crazy Patchwork" and embellishing.
	1333	Feather stitch variations 1333 – 1338	For "Crazy Patchwork" and embellishing.
	1339	Decorative Quilt stitch variations 1339 – 1345, 1351, 1355 – 1359, 1395 – 1398	For "Crazy Patchwork" and embellishing.

Stitch patterns	Stitch number	Name	Description
	1347	Quilt stitch/Handlook stitch variations 1347, 1348, 1350	Imitation of stipple quilting, to use with monofilament.
	1352	Blanket stitch dual	To edgestitch between two appliqués, "Crazy Patchwork".
	1353	Double blanket stitch dual	To edgestitch between two appliqués, "Crazy Patchwork".
	1354	Satin stitch	For appliqué.

10.2 Quilting, Securing Program

Prerequisite:

- The Reverse pattern foot No.1C is attached.



- > Touch the icon «Quilt stitches».
- > Select Quilt stitch pattern No. 1324.
- > Press the foot control.
 - The machine sews 6 stitches forward automatically when sewing is started.
- > Sew the seam in the desired length.

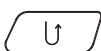

- > Push the button «Quick reverse».
 - The machine sews 6 stitches forward automatically and stops automatically at the end of the Securing Program.

10.3 Sewing handlook quilt stitches

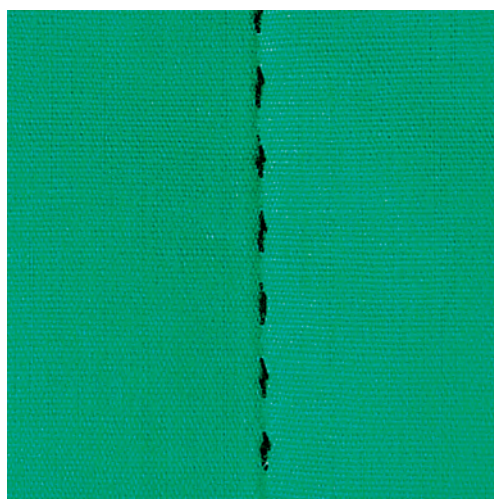

Handlook quilt stitches are suitable for all fabrics and sewing projects which should look hand sewn. It is recommended to use a monofilament thread as upper thread and an embroidery thread as bobbin thread. The sewing speed should be moderate to prevent the monofilament from breaking. If required, the upper thread tension and the balance can be adjusted to the sewing project and the desired quilt stitch.

> If there are knots on the wrong side of the fabric, move the fabric more quickly.

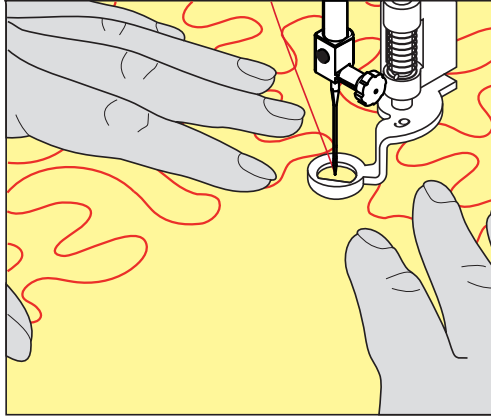

11 BERNINA Stitch Regulator (BSR)

The BERNINA Stitch regulator equalizes the stitch length which results of the free movement of the fabric while free-motion sewing - a sewing technique which grows more and more popular. When free-motion sewing with the BSR presser foot, every stitch is equally long and the stitch formation is perfectly regular.

As soon as the BSR presser foot is attached and the feed dog is lowered, the selection menu of the desired mode appears in the display of the machine. The BSR presser foot can be used with sewing straight stitch as well as zig zag.

The BSR presser foot reacts on the movement of the fabric and therefore controls the speed of the machine up to the highest possible speed. It can be said: The faster the movement of the material, the higher the speed of the machine.

If the fabric is moved too quickly, an acoustic signal sounds. The beeper can be activated or deactivated in the «BSR» display. The sound of the beeper can also be activated or deactivated in the Setup Program.

11.1 BSR mode 1

The BSR function can be controlled via the foot control or with the button «Start/Stop». Start the BSR mode. At the BSR presser foot a red light is on. By moving the fabric the machine accelerates. If the fabric isn't moved, securing in place is possible without pressing an additional button. When working via the foot control or when using the button «Start/Stop», the BSR mode doesn't stop automatically.

11.2 BSR mode 2

The BSR function can be controlled via the foot control or the button «Start/Stop». The machine starts only when the foot control or the button «Start/Stop» is pressed and the fabric is moved simultaneously. Without moving the fabric, the BSR2 modus stops after about 7 seconds. The red light goes off (only when working with the button «Start/Stop»). When working via the foot control, the red light doesn't go off.

11.3 BSR function with Straight stitch No. 1

This function allows free-motion quilting with straight stitch and a pre-programmed stitch length up to 4 mm. The programmed stitch length is maintained within a certain speed, independent of the fabric movement.

11.4 BSR function with Zig zag No. 2

The zig zag can be used e.g. for thread painting. The set stitch length will **not** be maintained when sewing the zig zag stitch, but the BSR function simplifies the application.

11.5 Sewing preparations for quilting

Attach the BSR presser foot

NOTICE

The lens of the BSR presser foot is dirty

The machine doesn't recognize the BSR presser foot.

> Clean the lens with a soft, slightly damp cloth.

> Change the presser foot.

- > Insert the cable of the BSR foot into the connection (1).



- > Switch the machine on.
 - The BSR display opens and the BSR 1 mode is activated.

Changing the presser foot sole

NOTICE

The lens of the BSR presser foot is dirty

The machine doesn't recognize the BSR presser foot.

- > Clean the lens with a soft, slightly damp cloth.

The standard stitch length is 2 mm. When sewing small shapes and stippling it is recommended to shorten the stitch length to 1 – 1.5 mm.

- > Raise the needle.
- > Raise the BSR foot.
- > Switch the machine off and disconnect it from the power supply system.
- > Remove the BSR foot from the machine.
- > Press both push buttons at the BSR foot against each other.

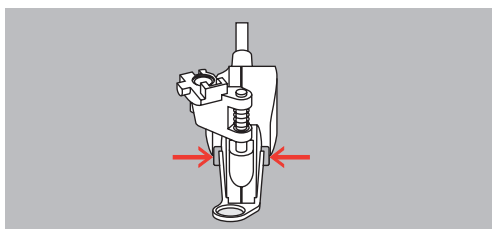

- > Pull the presser foot sole out of the guide downwards.
- > Insert the new presser foot sole into the guide and push upwards until it clicks into place.
- > Attach the BSR presser foot.

11.6 Using the BSR mode

The BSR function can be controlled via the foot control or the button «Start/Stop».

Starting via the foot control: The foot control needs to be pressed while quilting. The machine keeps running in the BSR1 mode until the foot control is released, even if the fabric isn't moved.

If quilting is stopped in the BSR2 mode, the machine sews another stitch depending on the needle position and stops with needle position up.

Prerequisite:

- The slide-on table is attached.
- The knee lifter of the Free Hand System is attached.

> Lower the feed dog.

> Select the desired BSR mode.



> Push the button «Start/Stop» or press the foot control to lower the presser foot.

> Push the button «Start/Stop» again or press the foot control again and keep pressed to start the BSR mode.

- At the BSR presser foot a red light is on.

> Move the fabric to control the speed of the machine in the BSR mode.



> Push the button «Start/Stop» again or release the foot control to stop the BSR mode.

- The BSR mode stops and the red light at the presser foot goes off.

> Touch the icon «BSR» (1) to deactivate the BSR mode and to quilt without automatic stitch length.



11.7 Securing

Securing in BSR1 mode with the button «Start/Stop»

Prerequisite:

- The BSR presser foot is attached and connected with the machine.
- The BSR display is opened and the BSR1 mode is activated.

> Lower the feed dog.

> Lower the presser foot.



> Push the button «Needle up/down» twice.

- The bobbin thread is brought up.

> Hold the upper and the bobbin thread.



> Push the button «Start/Stop».

- Start the BSR mode.

> Sew 5 – 6 securing stitches.



> Push the button «Start/Stop».

- The BSR mode stops.

> Cut the thread.

Securing in BSR2 mode

Prerequisite:

- The BSR presser foot is attached and connected with the machine.
- The BSR display is open and the BSR2 mode is activated.

> Lower the presser foot.



- > Push the button «Securing».
- > Press the foot control or the button «Start/Stop».

By moving the fabric some short securing stitches are sewn, then the programmed stitch length is activated and the securing function is deactivated automatically.



12 My BERNINA Embroidery

12.1 Overview Embroidery module

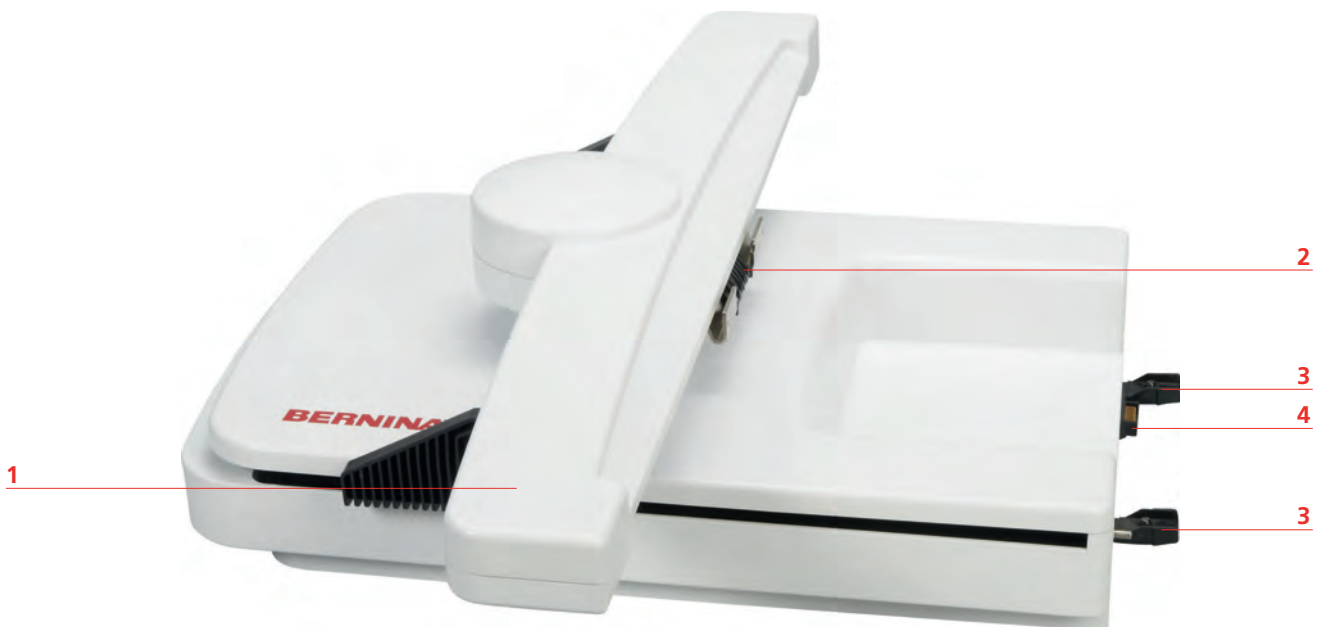

- | | |
|---|-------------------------------|
| 1 Embroidery arm | 3 Guide rails for the machine |
| 2 Bracket for attaching the embroidery hoop | 4 Connection to the machine |

12.2 Supplied accessories Embroidery module

Overview accessory Embroidery module

All rights reserved: For technical reasons and for the purpose of product improvements, changes concerning the features of the machine can be made at any time and without advance notice. The supplied accessory can vary depending on the country of delivery.

Please visit www.bernina.com for more accessory information.









Illustration	Name	Purpose
	Embroidery foot # 26	For embroidering, darning and free-motion quilting.
	Large oval embroidery hoop	To embroider large embroidery motifs or motif combinations up to 145 x 255 mm (5.70 x 10.04 in). Including the template for precise fabric positioning.

Illustration	Name	Purpose
	<p>Medium embroidery hoop</p>	<p>To embroider medium-sized embroidery motifs up to 100 x 130 mm (3.94 x 5.12 in).</p> <p>Including the template for precise fabric positioning.</p>
	<p>Small embroidery hoop</p>	<p>To embroider small embroidery motifs up to 72 x 50 mm (2.83 x 1.97 in).</p> <p>For free arm embroidering with closed sewing projects such as sleeves, trouser legs or socks.</p> <p>Including the template for precise fabric positioning.</p>
	<p>USB Connecting cable</p>	<p>To transfer data from the computer to the machine or vice versa.</p>
	<p>Embroidery needle assortment</p>	<p>For embroidering.</p>
	<p>Template holder</p>	<p>To place and remove the template in or out of the embroidery hoop.</p>
	<p>Net for upper thread spool</p>	<p>To support an even unwinding of the thread with slippery embroidery threads.</p>

12.3 Overview User Interface

Overview functions/visual information



- | | | | |
|---|---|---|--------------------------------|
| 1 | Upper thread tension | 5 | Stitch plate selection |
| 2 | Needle selection | 6 | Feed dog up/down |
| 3 | Presser foot indicator/Presser foot selection | 7 | Filling level of bobbin thread |
| 4 | Embroidery hoop display/Embroidery hoop selection | | |

Overview System settings



- | | | | |
|---|-----------------------|---|-------------------------|
| 1 | Home | 5 | Help |
| 2 | Setup Program | 6 | eco mode |
| 3 | Tutorial | 7 | Back to default setting |
| 4 | Embroidery Consultant | | |

Overview Selection menu embroidery



- | | | | |
|---|-----------------------------|---|-------------------|
| 1 | Selection embroidery motifs | 3 | Color information |
| 2 | Editing embroidery motifs | 4 | Embroidery |

12.4 Important Embroidery information

Upper thread

A good quality thread (brand manufacturer) is essential for embroidery so that the embroidery is not affected negatively because of poor thread or thread breakage.

Embroidery is particularly effective if you use 40wt glossy rayon or polyester embroidery threads as upper threads. They are available in a wide range of colors for beautiful embroidery.

- Glossy polyester with a brilliant sheen is a hard wearing, colorfast thread and has a high tensile strength which is suitable for all types of embroidery.
- Rayon is a soft viscose fiber with a brilliant sheen and suitable for fine, delicate embroidery, or items that will not receive excessive wear and tear.
- Metallic thread is a light to medium-weight thread suitable for special effects in embroidery.
- When working with metallic threads, the automatic bobbin thread cutter should be deactivated. The other thread cutters shouldn't be used either because the knives are likely to wear off very quickly.
- When using metallic threads, the speed and the upper thread tension should be reduced.



Bobbin thread

In most cases black or white bobbin thread is used for embroidering. When both sides should have the same look, it is recommended to use the same color for bobbin and upper thread.

- Bobbin Fill is an especially soft and light polyester thread which is suited well to be used as bobbin thread. This special bobbin thread ensures a steady thread tension and an optimal intertwining of the upper and bobbin thread.

13 Embroidering preparation

13.1 Attaching the Module

NOTICE

Transporting the embroidery module

Damage to the embroidery module connection and machine.

- > Remove the embroidery module before transporting the machine.

Prerequisite:

- The slide-on table must not be attached.
 - > Make sure that the module and the machine are placed on a stable, even surface.
 - > Make sure that there is enough space around to allow the unimpeded movement of the embroidery arm.
 - > Lift the embroidery module on the left.
 - > Carefully push the embroidery module from left to right into the embroidery module connection of the machine (1).

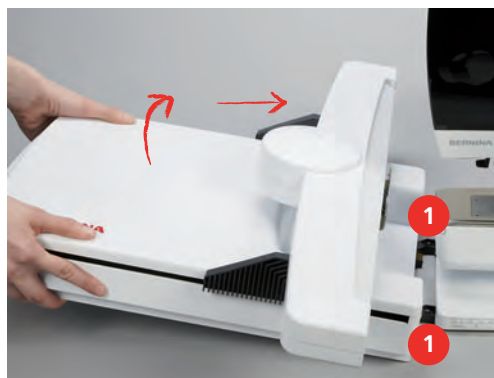

- > To remove the embroidery module, lift it on the left side and pull it carefully to the left.

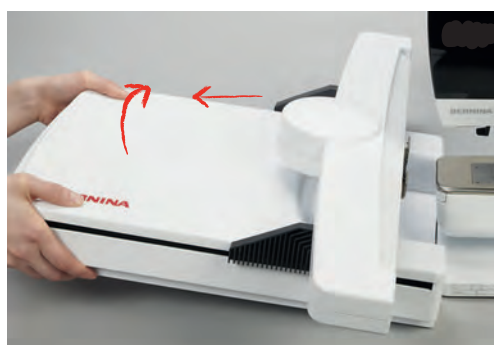

13.2 Preparing the machine

Lowering the feed dog

- > Push the button «Feed dog up/down» to lower the feed dog.



- > Attach the stitch plate CutWork/Straight (see page 160).
- > Insert the needle (see page 158).
- > Attaching the embroidery foot (see page 157).

Selecting the embroidery motif

All embroidery motifs can either be embroidered as-is or edited using the various functions offered by the embroidery machine. Please find all the embroidery motifs at the end of this instruction manual. All the stitch patterns contained in the sewing mode can also be embroidered. The stitch patterns are displayed in files, sorted in Categories, like in the sewing mode. In addition to that, embroidery motifs can be loaded from the personal memory or from the BERNINA USB stick (optional accessory).



- > Touch the icon «Home».



- > Touch the icon «Embroidery mode».
- > Select an alphabet, embroidery motif, stitch pattern or a personal embroidery motif from a file.

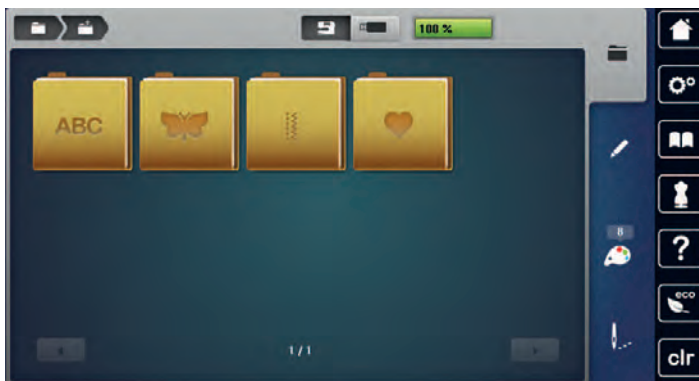

13.3 Embroidery foot

Attaching the embroidery foot

- > Raise the needle.
- > Raise the presser foot.
- > Switch the machine off and disconnect it from the power supply system.

- > Push the clamping lever up.



- > Remove the presser foot.
- > Insert the embroidery foot from below into the bracket.
- > Press the clamping lever down.

Selecting the embroidery foot in the User Interface

After having attached the respective embroidery foot (Embroidery foot No. 26, supplied accessory with the embroidery module), you can select and save it on the machine. Moreover, alternative feet are displayed which will also be suitable for the selected embroidery motif.

- > Switch the machine on.
- > Select an embroidery motif.
- > Touch the icon «Presser foot display/Presser foot selection».



- > Touch the icon «Optional presser feet» to display all the suitable feet for the selected embroidery motif.
- > Select the attached embroidery foot.



13.4 Needle and stitch plate

Inserting the embroidery needle



Embroidery needles of the type 130/705 H-SUK provide a larger eye and are slightly rounded. This avoids thread abrasion when using Rayon- and cotton embroidery thread. Depending on the embroidery thread use a size No. 70-SUK to No. 90-SUK needle.

- > Raise the needle.
- > Switch the machine off and disconnect it from the power supply system.
- > Remove the attached foot.

- > Loosen the fixing screw of the needle using the screwdriver gray Torx.



- > Pull the needle down.
- > Hold the new needle with the flat side to the back.
- > Insert the needle as far as it will go.
- > Tighten the fixing screw of the needle using the screwdriver gray Torx.

Selecting the embroidery needle in the User Interface

After having changed the needle, it can be checked whether or not it is suitable to be used together with the selected stitch plate.



- > Touch the icon «Needle selection».
- > Select the inserted needle.



- If the selected needle is suitable in combination with the stitch plate, embroidering can be started.
- If the selected needle is not suitable in combination with the stitch plate, starting the machine is automatically blocked.

Selecting needle type and needle size

Convenient memory function: To prevent a loss of information, the needle type and the needle size can be saved additionally on the machine. The saved needle type and the saved needle size can be checked at any time.



- > Touch the icon «Needle selection».

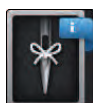

- > Touch the icon «Needle type/Needle size».
- > Select the needle type (1) of the inserted needle.

- > Select the needle size (2) of the inserted needle.



Attaching the stitch plate

The stitch plate (CutWork/Straight, supplied accessory) has a small needle hole in the needle insertion area. The thread is pulled in and knotted optimally which results in an optimized stitching result.

- > Push the button «Feed dog up/down» to lower the feed dog.



- > Switch the machine off and disconnect it from the power supply system.
- > Remove the needle.
- > Remove the presser foot.
- > Press the stitch plate down at the mark back right until it flips up.



- > Remove the stitch plate.
- > Place the openings of the stitch plate (CutWork/Straight, supplied accessory) above the corresponding guide pins and press down until it clicks into place.

Selecting the stitch plate in the User Interface

After having changed the stitch plate, it can be checked whether or not it is suitable to be used together with the selected needle.

- > Touch the icon «Stitch plate selection».



- > Select the attached stitch plate (CutWork/Straight, supplied accessory).



Thread-up command

The machine must be ready for embroidery to bring up the bobbin thread. The bobbin thread can be brought up in one step for a manual knotting. If no securing stitches are wanted, it is recommended to deactivate the securing stitches in the Setup.



- > Hold the upper thread.
- > Press the button «Needle up/down».
 - The bobbin thread is brought up automatically.

13.5 Embroidery hoop

Overview embroidery hoop selection

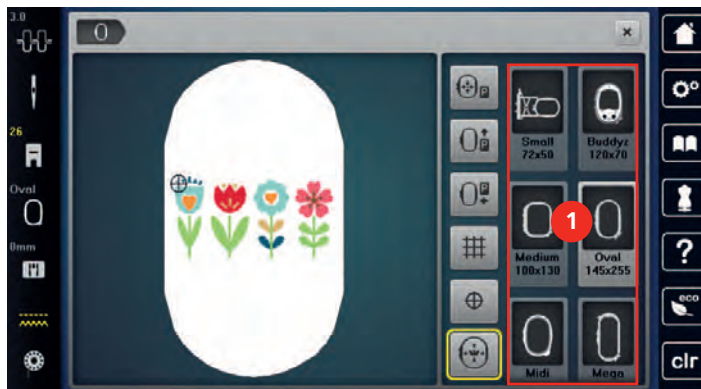

- 1 Hoop selection

Selecting the embroidery hoop

The best embroidery result is achieved when the smallest possible embroidery hoop for the embroidery motif is selected.

The embroidery motif has a pre-set size which is displayed.

Prerequisite:

- The embroidery motif is selected.



- > Touch the icon «Hoop selection».
 - The machine selects the optimal embroidery hoop according to the size of the embroidery motif automatically. If the pre-set embroidery hoop would not be available, another desired embroidery hoop can be selected. When an embroidery hoop is attached which does not correspond with the selected one, the attached hoop is considered active and the embroidery motif area is displayed accordingly.
- > Select the desired embroidery hoop.

Tear-away stabilizers

Using a stabilizer ensures more stability of the embroidery project. A tear-away stabilizer suits all woven and non-stretch materials. 1 – 2 layers can be used. Stabilizers are available in different weights. With larger embroidered areas the stabilizer will remain under the embroidery thread. The stabilizer is applied to the wrong side of the fabric with temporary adhesive spray. Carefully tear away excess stabilizer after embroidering.

Cut-away stabilizers

Using a stabilizer ensure more stability of the embroidery project. A cut-away stabilizer suits all elastic materials. 1 – 2 layers can be used. Stabilizers are available in different weights. With larger areas to be embroidered the stabilizer will remain under the embroidery thread. The stabilizer is applied to the wrong side of the fabric with temporary adhesive spray. Carefully cut away excess stabilizer after embroidering.

Using adhesive spray

The application of spray adhesive is recommended for stretch and smooth materials and knitware. It prevents the fabric from losing shape and slipping. Appliqués can be exactly positioned with spray adhesive. The spray adhesive shouldn't be used near the machine to avoid contamination.

- > Use the adhesive spray carefully at a distance 25 – 30 cm (9 – 12 inch) when spraying the stabilizer.
- > Adhere the sprayed stabilizer to the wrong side of the fabric carefully, smoothing material so there are no puckers.
- > Position smaller parts such as pocket flaps or collars on the stabilizer.
- > To avoid the possibility of getting hoop marks when working with napped materials or fleece, don't hoop the parts but spray the stabilizer and hoop it.
- > Adhere the fabric to be embroidered.
- > Remove any adhesive residue before starting the machine.

Using spray starch

Spray starch is ideal for additional stiffening fine, loosely woven materials. Always use an additional stabilizer on the wrong side of the material.

- > Spray the area to be embroidered.
- > Let it dry or press gently with a warm iron if necessary.

Using iron-on interfacing

Iron-on interfacings are available in a variety of weights. It is recommended to use an iron-on interfacing which is easily removable from the basic fabric. An Iron-on interfacing suits all materials that are easily distorted like stretch fabric such as tricot and jersey.

- > Iron-on interfacings are ironed to the wrong side of the material using a warm iron.

Using paper-backed adhesive stabilizer

Paper-backed adhesive stabilizers are intended to be used for fabrics such as jersey and silk as well as for embroidery projects which are not suited to be hooped in the embroidery hoop.

- > Place the stabilizer in the hoop, so that the paper side is up.

- > Use a pair of scissors to score the paper and remove paper in the hoop area.
- > Position the fabric to be embroidered on the stabilizer and press it on place.
- > Remove any adhesive residue before starting the machine.

Using water-soluble stabilizer



For lace embroidery it is recommended to hoop 1 – 3 layers of water-soluble stabilizer in the embroidery hoop. As the embroidery motif is not embroidered on the fabric, only the thread embroidered motif is left. The embroidery motifs should be combined with short stitches otherwise the individual motifs may fall out.

The stabilizer dissolves in water. Water-soluble stabilizers are an ideal protection for looped pile fabrics preventing the loops from being damaged! It prevents threads from sinking into the material and keeps the fabric pile from poking through the embroidery. Water-soluble stabilizers are ideal for fine, sheer fabrics where other stabilizers may show through the embroidery stitches as well as for lace embroidery.

- > Place the stabilizer on top of the material.
- > Place all the layers together into the embroidery hoop.
- > Use adhesive spray to adhere stabilizer if necessary.
- > For material with a pile, reinforce with additional, suitable stabilizer on the wrong side. In addition to that a water-soluble stabilizer can be placed on top of the material and fixed with basting stitches.
- > After dissolving, lay the motif down flat and let dry.

Preparing the embroidery hoop

The embroidery hoop consists of an outer and an inner hoop. There is a corresponding template for every hoop. The area to be embroidered is marked in 1 cm (0.39 inch) squares. The center and corner points are marked with holes. The required marks can be transferred to the material.

- > Mark the center of an embroidery motif on the fabric, using a water-soluble pen.

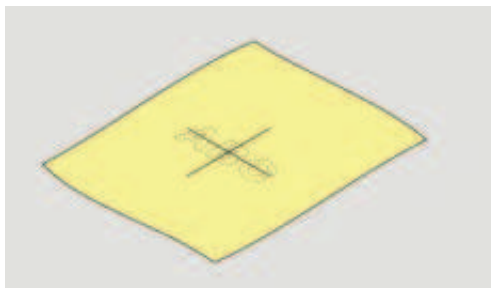

- > Loosen the screw on the outer hoop.
- > Remove the inner hoop.
- > Make sure that the arrows marks of both hoops match.
- > Attach the template holder.
- > Place the template in the inner hoop, so the BERNINA logo is at the front edge at the arrow mark until it clicks into place.

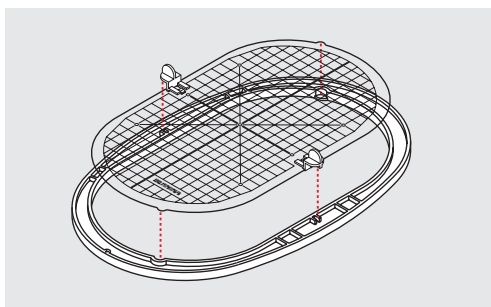

- > Place the material under the inner hoop.

Overview Embroidery functions



- | | | | |
|---|--|---|---------------------|
| 1 | Center the needle to the embroidery hoop | 4 | Grid on/off |
| 2 | Moving the hoop to the back | 5 | Motif center |
| 3 | Moving the module for the sewing mode | 6 | Virtual positioning |

Center the needle to the embroidery hoop

Relocating the embroidery hoop facilitates threading when the needle is close to the embroidery hoop.



- > Touch the icon «Embroidery hoop display/Embroidery hoop selection».



- > Touch the icon «Center the needle to the embroidery hoop».
- > Threading the upper thread.



- > Push the button «Start/Stop» to move the embroidery hoop back to the last position.

Moving the hoop to the back

To facilitate changing the bobbin, it is recommended to move the hoop to the back before threading. This makes it easier to open the bobbin cover.



- > Touch the icon «Embroidery hoop display/Embroidery hoop selection».



- > Touch the icon «Move the hoop to the back».
- > Thread the bobbin thread (see page 54).



- > Push the button «Start/Stop» to move the embroidery hoop back to the last position. If necessary, pull the upper thread back.

Moving the module for the sewing mode

The embroidery module can be positioned so that any sewing projects can be carried out even if the module is connected.



- > Touch the icon «Embroidery hoop display/Embroidery hoop selection».
- > Remove the hoop.



> Touch the icon «Move the module for the sewing mode».



> Touch the icon «Home».



> Touch the icon «Sewing mode».

Grid on/off

When the center of the hoop and the grid are displayed, the embroidery motif can be positioned more exactly.



> Touch the icon «Embroidery hoop display/Embroidery hoop selection».

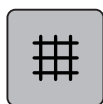

> Touch the icon «Grid on/off» to display the center of the hoop on the display.

> Touch the icon «Grid on/off» again to display the grid.

> Touch the icon «Grid on/off» again so that the center of the hoop and the grid disappear.

Locating the center of the embroidery motif

The embroidery hoop is positioned so that the needle is exactly above the center of the embroidery motif or the motif begin.



> Touch the icon «Embroidery hoop display/Embroidery hoop selection».



> Touch the icon «Center of the embroidery motif» to position the hoop so that the needle is placed exactly over the center of the embroidery motif.

> Touch the icon «Center of the embroidery motif» again to position the hoop so that the needle is placed exactly over the motif start.

Virtual positioning of the embroidery hoop

The embroidery hoop is automatically moved to the new position as soon as the embroidery motif is repositioned. Therefore, the icon «Virtual positioning» is activated automatically and outlined in yellow when an embroidery hoop is attached.

Prerequisite:

- The hoop is attached.



> Touch the icon «Embroidery hoop display/Embroidery hoop selection».



> Touch the icon «Virtual positioning» to deactivate the automatic movement of the hoop when having repositioned the embroidery motif.

– The icon «Virtual positioning» is not outlined in yellow.

> Touch the icon «Virtual positioning» again to activate the automatic movement of the hoop when having repositioned the embroidery motif.

14 Setup Program

14.1 Adjusting the embroidery settings in the Setup Program

Further information about this topic (see page 62).

15 Creative embroidering

15.1 Overview embroidering



- | | | | |
|---|---|---|-------------------------|
| 1 | Embroidery time/Embroidery motif size in mm or inch | 4 | «i»-Dialog |
| 2 | Scaling up, downsizing and moving the embroidery motif view | 5 | Embroidery motif layers |
| 3 | Area to be embroidered | | |

15.2 Selecting and changing the embroidery motif



> Touch the icon «Selection».



- > Touch the icon «Upload embroidery motif».
- > Select a new embroidery motif.

15.3 Checking the embroidery time and the embroidery motif size

In the selection menu «Editing» the estimated embroidery time in minutes as well as the width and height of the embroidery motif is indicated at lower left (1).



15.4 Regulating the speed

The sewing speed can be adjusted infinitely variable with the slide.

- > Move the slide to the left to reduce the sewing speed.
- > Move the slide to the right to increase the sewing speed.

15.5 Editing the embroidery motif

Overview Editing embroidery motif



- | | | | |
|---|-------------------------|----|---|
| 1 | Moving the view | 10 | Mirror image up/down |
| 2 | Moving the motif | 11 | Duplicating |
| 3 | Zoom out | 12 | Endless Embroidery |
| 4 | Zoom in | 13 | Deleting |
| 5 | Moving the motif | 14 | Check embroidery motif size |
| 6 | Rotating the motif | 15 | Bending the text |
| 7 | Altering the size | 16 | Grouping embroidery motifs |
| 8 | Pinpoint placement | 17 | Changing the sequence within an embroidery motif combination (appears by scrolling) |
| 9 | Mirror image left/right | 18 | Altering the stitch type/stitch density (appears by scrolling) |

Scaling up the embroidery motif view

The view of the embroidery motif can be scaled up. In addition to that, the view can be adjusted with or without changing the embroidery position.

- > Select an embroidery motif.
- > Touch the icon «Zoom in» to edit the view of the embroidery motif.



- > Touch the icon «Zoom in» 1 to 4 times to enlarge the view of the embroidery motif gradually.



- > Touch the icon «Zoom out» 1 to 4 times to get back to the Edit Mode.

Downsizing the embroidery motif view

The view of the embroidery motif can be downsized. In addition to that, the view can be adjusted with or without changing the embroidery position.

- > Select an embroidery motif.
- > Touch the icon «Zoom in» to edit the view of the embroidery motif.



- > Touch the icon «Zoom out» 1 to 4 times to downsize the view of the embroidery motif gradually.

Moving the embroidery motif view

The view of the embroidery motif can be moved. In addition to that, the view can be adjusted with or without changing the embroidery position.



- > Select an embroidery motif.
- > To activate the icon «Move the view», touch the icon «Zoom in».



- > Touch the icon «Move the view».
 - The icon turns dark gray.
- > Alter the view of the embroidery motif.
 - The embroidery position is not altered.



- > Touch the icon «Zoom out» to get back to the Edit Mode.

Moving the embroidery motif in enlarged view

The view of the embroidery motif can be moved. In addition to that, the view can be adjusted with or without changing the embroidery position.



- > Select an embroidery motif.
- > To activate the icon «Move the view», touch the icon «Zoom in».



- > Touch the icon «Move the stitch pattern».
- > Move the view of the embroidery motif using the touchscreen pen/finger.
 - The embroidery position is altered.



- > Touch the icon «Zoom out» to get back to the Edit Mode.

Moving the embroidery motif



- > Select an embroidery motif.
- > Touch the icon «i»-Dialog.



- > Touch the icon «Move the stitch pattern».
- > Turn the «Upper Multifunction knob» to move the embroidery motif horizontally in 1/10-mm steps.
- > Turn the «Lower Multifunction knob» to move the embroidery motif vertically in 1/10-mm steps or
- > touch the embroidery motif, keep it pressed and move it as you like.
 - The relocation is indicated in the yellow-framed icons.

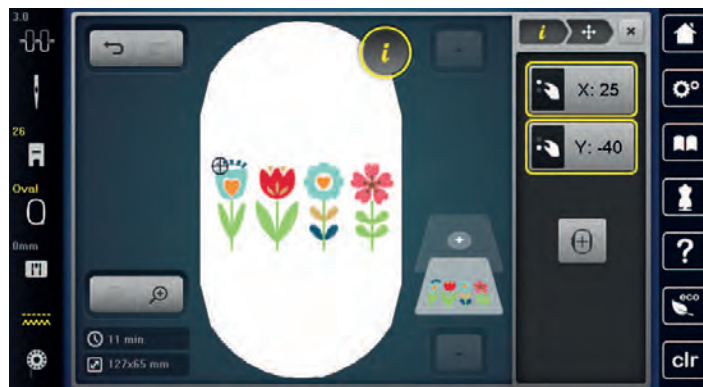

- > Touch the icon «Center of the embroidery motif».
 - The embroidery motif is repositioned in the center of the embroidery hoop.

Rotating motif



- > Select an embroidery motif.
- > Touch the icon «i»-Dialog.

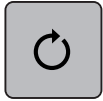

- > Touch the icon «Rotate the motif».
- > Turn the «Upper Multifunctional knob» or the «Lower Multifunctional knob» to the right to rotate the embroidery motif clockwise.
- > Turn the «Upper Multifunctional knob» or the «Lower Multifunctional knob» to the left to rotate the embroidery motif counter-clockwise.



- > Touch the icon «Rotate the motif +90°» to rotate the embroidery motif in 90°-steps.

Altering the embroidery motif size proportionally



Enlargements or reductions of the motif size up to maximum 20% achieve the best results.

If the motif size is to be altered by more than 20%, the motif should be adapted in a separate embroidery software and then reloaded onto the machine.



- > Select an embroidery motif.
- > Touch the icon «i»-Dialog.



- > Touch the icon «Alter the embroidery size».



- > Touch the icon «Retain the proportions» so that the icon is outlined in white.



- > Turn the «Upper/Lower Multifunction knob» to the right to scale up the embroidery motif proportionally.
- > Turn the «Upper/Lower Multifunction knob» to the left to downsize the embroidery motif proportionally.

Altering the embroidery motif size disproportionally



Enlargements or reductions of the motif size up to maximum 20% achieve the best results.

If the motif size is to be altered by more than 20%, the motif should be adapted in a separate embroidery software and then reloaded onto the machine.

- > Select an embroidery motif.



> Touch the icon «i»-Dialog.



> Touch the icon «Alter the embroidery size».



> To alter the embroidery motif disproportionately, touch the icon «Retain the proportions» so that the icon is not framed in white.



> Turn the «Upper Multifunctional knob» to move the embroidery motif horizontally.

> Turn the «Lower Multifunctional knob» to alter the embroidery motif vertically.

Mirroring embroidery motifs

Embroidery motifs can be mirror-imaged both vertically and horizontally.



> Select an embroidery motif.

> Touch the icon «i»-Dialog.



> Touch the icon «Mirror image left/right» to mirror the embroidery motif vertically.



> Touch the icon «Mirror image up/down» to mirror the embroidery motif horizontally.

Bending the text

Texts can be arranged and designed arc-shaped.



> Create an alphabet embroidery motif.

> Touch the icon «i»-Dialog.



> Touch the icon «Bend text».

> Turn the «Upper Multifunctional knob» to alter the distance between the characters in millimeter-steps.

> Turn the «Lower Multifunctional knob» to the left or to the right to bend the lettering upwards or downwards.

Changing the stitch type

If the satin stitches are too long, they can be changed to step stitches.

- > Select an embroidery motif.
- > Touch the icon «i»-Dialog.



- > Touch the icon «Change the stitch type».



- > Touch the switch in the upper section of the display (1) to change the satin stitch to the step stitch.
- > Adjust the desired stitch length (2) with the icons «-» or «+».

Altering the stitch density

If the satin stitches are embroidered too densely, the stitch density can be adjusted.

- > Select an embroidery motif.
- > Touch the icon «i»-Dialog.



- > Touch the icon «Change the stitch type».
- > Adjust the desired stitch density (1) with the icons «-» or «+».



Checking the size and the position of the embroidery motif

It can be checked whether or not the embroidery motif matches the designated position/location on the fabric. Points which are beyond the embroidery hoop are not traveled to.

- > Select an embroidery motif.
- > Touch the icon «i»-Dialog.



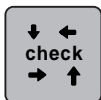

- > Touch the icon «Check embroidery motif size».
 - The embroidery hoop travels all the way until the needle is at the position as it is indicated in the display.
- > Touch the icon «Corner top left» to select the top left corner of the embroidery motif.
 - The embroidery hoop travels all the way until the needle is at the position as it is indicated in the display.
- > Touch the icon «Corner top right» to select the top right corner of the embroidery motif.
 - The embroidery hoop travels all the way until the needle is at the position as it is indicated in the display.
- > Touch the icon «Corner bottom left» to select the bottom left corner of the embroidery motif.
 - The embroidery hoop travels all the way until the needle is at the position as it is indicated in the display.
- > Touch the icon «Corner bottom right» to select the bottom right corner of the embroidery motif.
 - The embroidery hoop travels all the way until the needle is at the position as it is indicated in the display. If the embroidery motif hasn't been positioned correctly yet, the position can be altered via the «Upper/Lower Multifunction knobs» and the complete embroidery positions can be checked again.

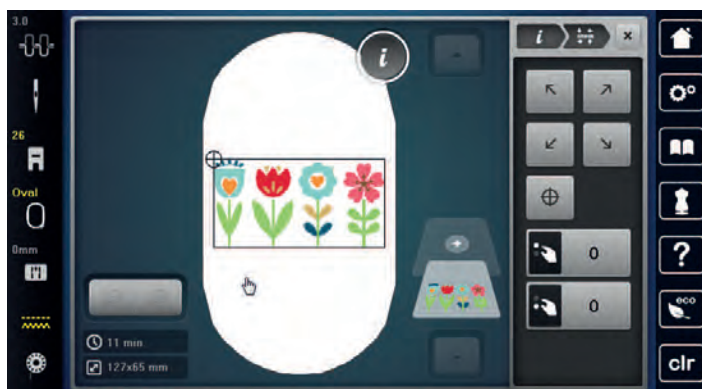

- > Touch the icon «Embroidery motif center» to bring the needle to the center of the embroidery motif.
- > Turn the «Upper Multifunctional knob» to move the embroidery motif horizontally.
- > Turn the «Lower Multifunctional knob» to move the embroidery motif vertically.

Endless embroidery

When embroidering a border, it is advantageous to use the «Mega-Hoop» (optional accessory) or the «Maxi-Hoop» (optional accessory). The embroidery project requires less rehooping. We recommend marking reference lines on the fabric, and using the template when hooping and rehooping. Here, the reference lines must run parallel to the lines on the template. In the following example, the supplied «Oval-Hoop» is used.



- > Select an embroidery motif.
- > Touch the icon «i»-Dialog.



- > Touch the icon «Endless Embroidery».
 - The embroidery motif will be duplicated as many times as possible to fill the hoop.
 - The reference points, which are necessary when rehooping the fabric, are added.
- > Add further reference points, if necessary, using the arrow icons (1).
- > Turn the «Upper Multifunctional knob» or
- > touch the icons «-/+» (2) to enter the number of embroidery motifs.
- > Turn the «Lower Multifunctional knob» or
- > touch the icons «-/+» (3) to determine the distance between the embroidery motifs.



> Touch the icon «Fit to hoop» (4) to adjust the size of the motifs automatically so they all fit in the hoop.



> Touch the icon «Confirm».

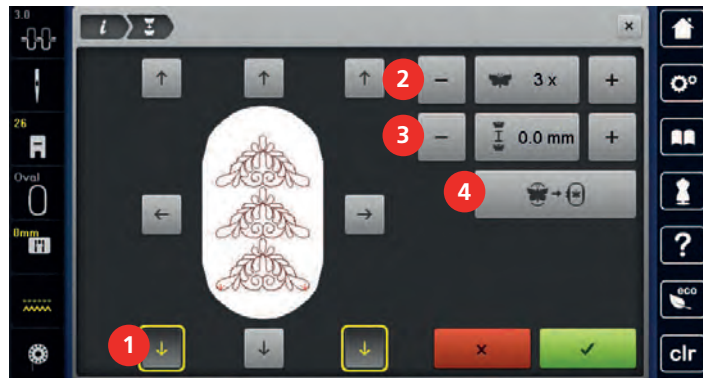

> Touch the icon «i»-Dialog.



> Touch the icon «Embroidering».



> Push the button «Start/Stop» and embroider the border.
– The embroidery motif must be embroidered completely.

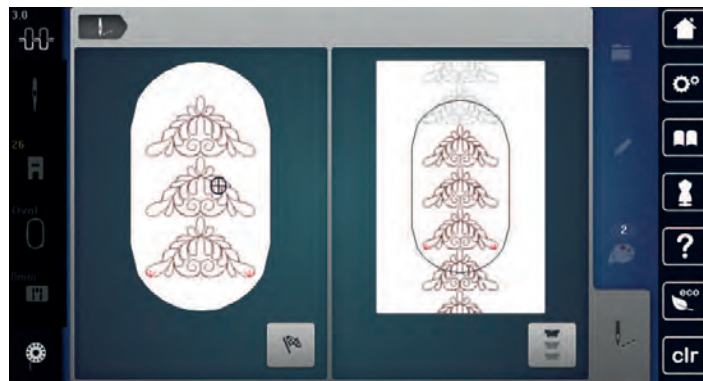

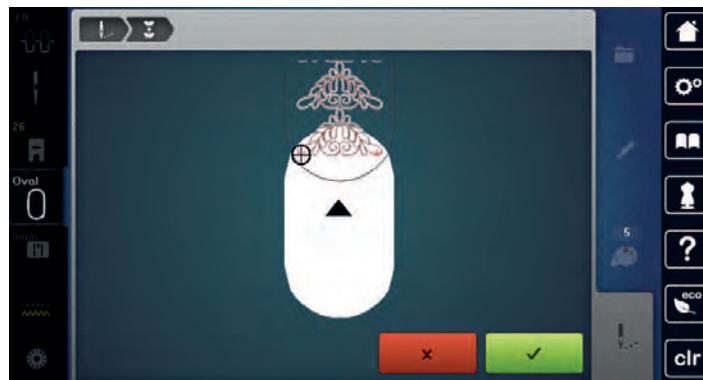

> Touch the icon «Endless Embroidery» when the reference points have been embroidered.
– An animation indicates that the fabric must be rehooped.

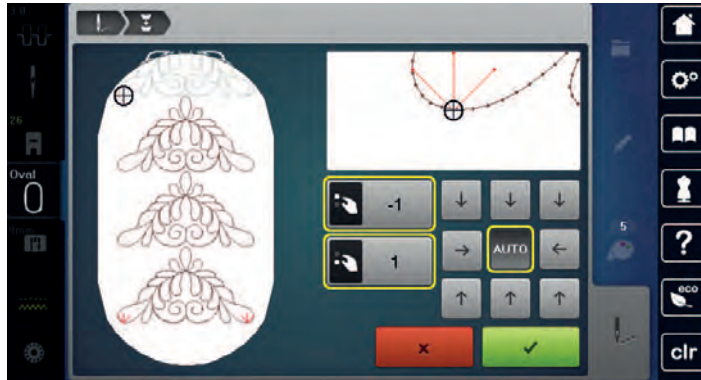

> Remove the hoop and rehoop the fabric so that the stitched out reference points are in the upper part of the embroidery area and at least 3 cm (1.18 inch) from the top edge of the hoop.
> Attach the hoop.

- > Touch the icon «Confirm».
 - The embroidery hoop is moved automatically close to the reference point.
 - The icon «AUTO» is activated and the hoop moves automatically near the last reference point.
- > Via the arrow icons, determine on which side of the embroidered part the next reference point shall be placed.
- > Turn the «Upper Multifunctional knob» or the «Lower Multifunctional knob» to position the hoop exactly.



- > Touch the icon «Confirm».
-  > Push the button «Start/Stop» and resume embroidering.
- > Repeat these steps until the desired length of the border is embroidered.

Duplicating the embroidery motif

The active embroidery motif is duplicated.

- > Select an embroidery motif.
- > Touch the icon «i»-Dialog.



- > Touch the icon «Duplicate».



Deleting an embroidery motif

The active embroidery motif is deleted.

- > Select an embroidery motif.
- > Touch the icon «i»-Dialog.



- > Touch the icon «Delete».



Changing the sequence within an embroidery motif combination

The sequence of the embroidery motifs within the embroidery motif combination can be changed.

Prerequisite:

- The embroidery motif combination has been created or the motif has been ungrouped.



- > Select the desired embroidery motif which is to be repositioned.
- > Touch the icon «i»-Dialog.



- > Touch the icon «New Allocation».



- > Touch the icon «Scroll up» to position the selected embroidery motif further up within the sequence.



- > Touch the icon «Scroll down» to position the selected embroidery motif further down within the sequence.

Undoing entries

All entries can be undone and redone again step by step.

Prerequisite:

- An embroidery motif has been selected and alterations have been done.



- > Touch the icon «Undo» to cancel the last entry.
- > Touch the icon «Undo» several times to cancel the last entries step by step.

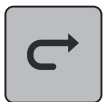

- > Touch the icon «Redo» to restore the last entry.
- > Touch the icon «Redo» several times to restore the last entries step by step.

Grouping embroidery motifs

Embroidery motifs can be added to a combination or removed. The grouped embroidery motifs can be edited like one single embroidery motif.

The sequence of the embroidery motifs in the combination can be changed (see page 176).

As soon as an embroidery motif has been ungrouped, in other words, it has been decomposed in different elements/colors, the colors won't be recomposed. With alphabets, the jumpstitch length needs to be adjusted to 1 in the Setup so that ungrouping will work with all the letters.

- > Create an embroidery motif combination.
- > Select an embroidery motif (1) within the embroidery motif combination.



- > Touch the icon «i»-Dialog.



> Touch the icon «Group».



> Touch the icon «Group».
– The embroidery motif above the selected embroidery motif is added to the embroidery motif combination.

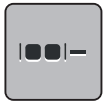

> Select an embroidery motif combination.
> Touch the icon «Ungroup».
– The combination is ungrouped.

or

> Create an embroidery motif combination.
> Select all embroidery motifs (2).

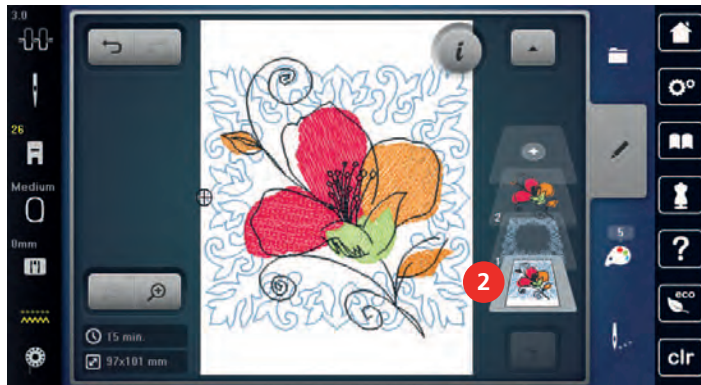

> Touch the icon «i»-Dialog.

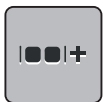

> Touch the icon «Group».
– All embroidery motifs are added to the embroidery motif combination.
> Select an embroidery motif combination.

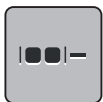

> Touch the icon «Ungroup».
– The combination is ungrouped.

15.6 Pinpoint placement

Positioning of grid points

This function allows the exact positioning of the embroidery motif on the fabric in an easy way. The positioning points can be placed in the grid.

Prerequisite:

- Any two points of the embroidery motif are marked with chalk or a water-soluble pen on the fabric. The place or the location where the embroidery motif is to be positioned is clearly visible.

> Select an embroidery motif.
> Touch the icon «i»-Dialog.





> Touch the icon «Pinpoint placement».

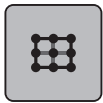

- > Touch the icon «Grid».
 - The embroidery motif is given a grid with nine different location/positioning points.
- > Select the desired positioning point to which the embroidery motif is to be adjusted.
 - The point changes its color.



- > Turn the «Upper Multifunctional knob» or the «Lower Multifunctional knob» to the left or to the right to position the needle above the respective mark on the fabric.
- > Touch the icon «SET» to confirm the altered position.
 - The point changes its color and is defined.
- > Select the second positioning point of the embroidery motif.
- > Turn the «Upper Multifunctional knob» or the «Lower Multifunctional knob» to the left or to the right to position the needle above the respective mark on the fabric.

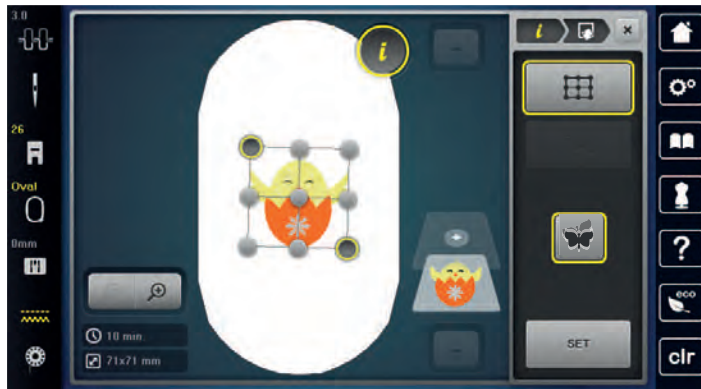

- > Touch the icon «SET» to confirm the altered position.
 - The point changes its color and is defined. The embroidery motif is adjusted accordingly.



> Touch the icon «Reset Pinpoint placement» to reset the alterations to default setting.

Free point positioning

This function allows the exact positioning of the embroidery motif on the fabric in an easy way. The points can be defined as you like within the embroidery motif.

Prerequisite:

- Any two points of the embroidery motif are marked with chalk or a water-soluble pen on the fabric. The place or the location where the embroidery motif is to be positioned is clearly visible.



- > Select an embroidery motif.
- > Touch the icon «i»-Dialog.



> Touch the icon «Pinpoint placement».



- > Touch the icon «Place points as desired».
- > Define a desired point within the embroidery motif.
 - The positioning point is displayed.

SET

- > Turn the «Upper Multifunctional knob» or the «Lower Multifunctional knob» to the left or to the right to position the needle above the respective mark on the fabric.
- > Touch the icon «SET» to confirm the altered position.
 - The point changes its color and is defined.
- > Select the second positioning point of the embroidery motif.
- > Turn the «Upper Multifunctional knob» or the «Lower Multifunctional knob» to the left or to the right to position the needle above the respective mark on the fabric.



- > Touch the icon «SET» again to confirm the altered position.
 - The point changes its color and is defined. The embroidery motif is adjusted accordingly.
- > Touch the icon «Reset Pinpoint placement» to reset the alterations to default setting.



15.7 Combining embroidery motifs

Combining embroidery motifs

In the Combi-Mode several embroidery motifs can be combined.

- > Select an embroidery motif.
- > Touch the icon «Add an embroidery motif» (1).
- > Select another embroidery motif.



Deleting a single embroidery motif

Prerequisite:

- A combination of embroidery motifs has been created.

- > In the section of the embroidery motif level (1) touch the desired embroidery motif with the finger, keep it pressed and move it outwards.
 - A new window opens.



- > Touch the icon «Confirm» to delete the selected embroidery motif.

Duplicating the embroidery motif

- > Select an embroidery motif.
- > Touch the icon «i»-Dialog.



- > Touch the icon «Duplicate».
- The embroidery motif (1) is duplicated (2).



Duplicating a combination

When a combination is duplicated, the individual embroidery motifs cannot be selected anymore.

- > Select an embroidery motif.
- > Touch the icon «Add motif».
- > Select another embroidery motif.
- > Select the combination (1).



- > Touch the icon «i»-Dialog.





- > Touch the icon «Duplicate».
- The combination is duplicated (2).



15.8 Creating lettering

Overview embroidery alphabets

Embroidery motif		Name
ABC	ABC	Drifter
ABC	ABC	Childs Play
ABC		Victoria
<i>ABC</i>	<i>ABC</i>	Anniversary
ABC	ABC	Swiss Block
ABC		Quilt Block
ABC		Old English
АБВ	АБВ	Russian Textbook

Embroidery motif		Name
ABC		Happy Times
ABC		Bamboo
<i>ABC</i>		Lisa
<i>ABC</i>		Zurich
ABC		Flare Serif
ABC		Chicago
ABC		Deco block
ABC		Condensed Sans
<i>ABC</i>		Curly
ABC		Rounded Sans

Creating words/sentences



Lettering is always embroidered in one color. To embroider single letters or single words in another color, every letter or every word has to be selected individually and placed in the area to be embroidered.

Lettering can be positioned within the hoop as you like. When the embroidery motif is positioned outside the embroidering area, the hoop is outlined in red on the display. With the hoop selection it can be checked whether or not the embroidery motif can be embroidered in another hoop. When the lettering does not fit in any hoop, two single words can be combined and positioned below each other as the following example will show.



- > Select the file «Alphabets».
- > Select the font.
- > Enter the text «Made to».
- > Touch the icon (1) (standard setting) to use upper case letters.
- > Touch the icon (2) to use lower case letters.
- > Touch the icon (3) to use numbers and mathematic characters.

> Touch the icon (4) to use special characters.



> Touch the text box above the keyboard to delete the entered text completely.



> Touch the icon «DEL» to delete single letters of the entered text.



> Touch the icon «Confirm» to accept the text.



> Touch the icon «Embroidery hoop display/Embroidery hoop selection».

> Select the hoop.

> Touch the icon «Embroidery hoop display/Embroidery hoop selection» again to go back to the Edit Mode.

Editing words/sentences



> Touch the icon «i»-Dialog.

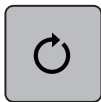

> Touch the icon «Rotate the motif».



> Touch the icon «+90» to rotate the text by 90°.

> Touch the icon «i» (1).

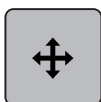

> Touch the icon «Move the stitch pattern».

> Turn the «Upper Multifunctional knob» to move the embroidery motif horizontally.

> Turn the «Lower Multifunctional knob» to move the embroidery motif vertically.

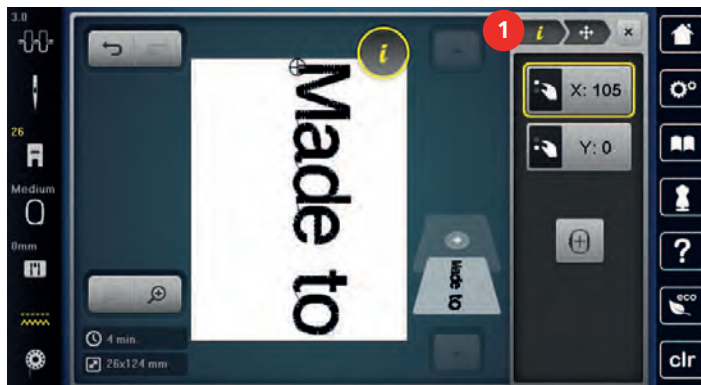

> Touch the icon «Add motif».

> Enter and also rotate the text «create».



> Touch the icon «Embroidery hoop display/Embroidery hoop selection».

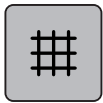

> Touch the icon «Grid on/off» to position the text lines more exactly.

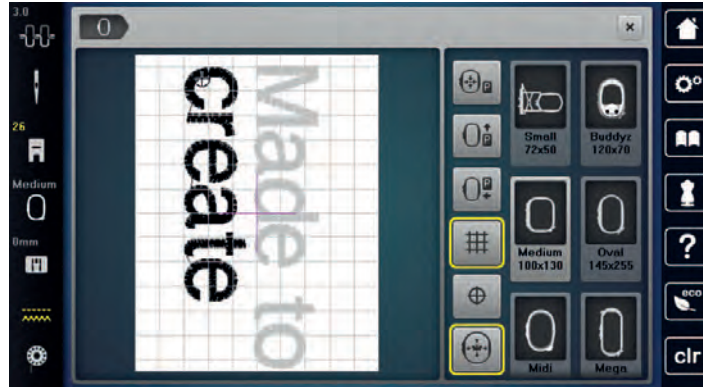

15.9 Changing the colors of the embroidery motif

Overview changing the color



- | | | | |
|---|-----------------------------|---|----------------------|
| 1 | Colors of embroidery motifs | 4 | Altering color/brand |
| 2 | Preview for selected color | 5 | Color information |
| 3 | Allocating thread brand | | |

Changing the colors



Lettering is always embroidered in one color. To embroider single letters or single words in another color, every letter or every word has to be selected individually and placed in the area to be embroidered.



> Select an embroidery motif.

> Touch the icon «Color information».

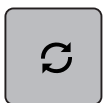

> Touch the icon «Alter color/brand» next to the color which is to be changed.



> Touch the icon «Scroll right» in the lower portion of the display to display other colors.



- > Touch the icon «Color selection by number» to select the color by entering the color number.
- > Select the desired color.
- > The color selection must be confirmed by touching the color bar on the right side.

Altering the colors via the color wheel

14



- > Touch the icon «Color information».
- > Touch the icon «Color wheel» (1).

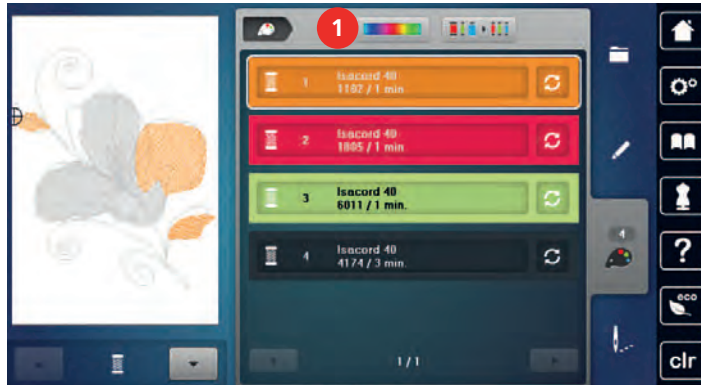

- > Turn the round knob (2) with the the touchscreen pen/finger clockwise or counter-clockwise or turn the «Upper Multifunction knob» to alter the colors of the embroidery motif.

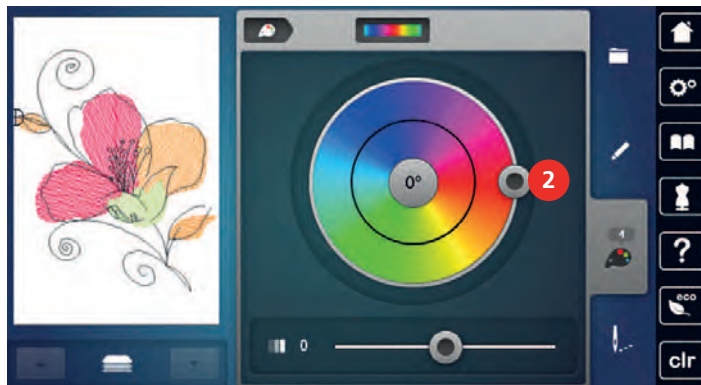



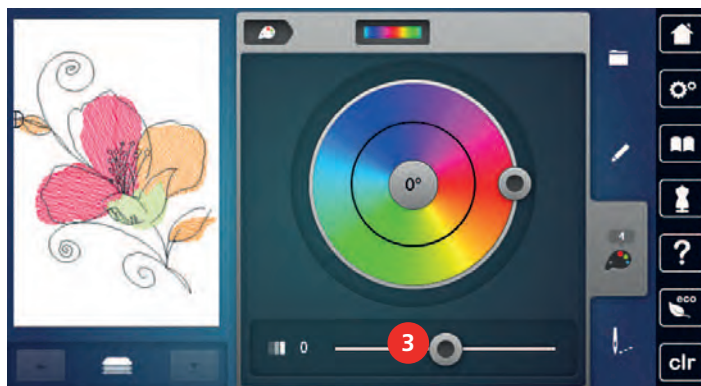

- > Move the slide (3) with the the touchscreen pen/finger to alter the brightness of the colors.



- > Touch the icon «Edit».
 - The embroidery motif appears in the new colors.

Changing the thread brand

- > Select the embroidery motif.

-  > Touch the icon «Color information».
-  > Touch the icon «Alter color/brand».
-  > To show more thread brands, touch the icons «Scroll left» and «Scroll rights» in the upper part of the screen.
-  > Touch the icon «Allocate thread brand».
-  > Touch the icon «Allocate thread brand».
 - Any thread colors of the selected embroidery motif will be matched with the selected thread brand.

15.10 Embroidering the embroidery motif



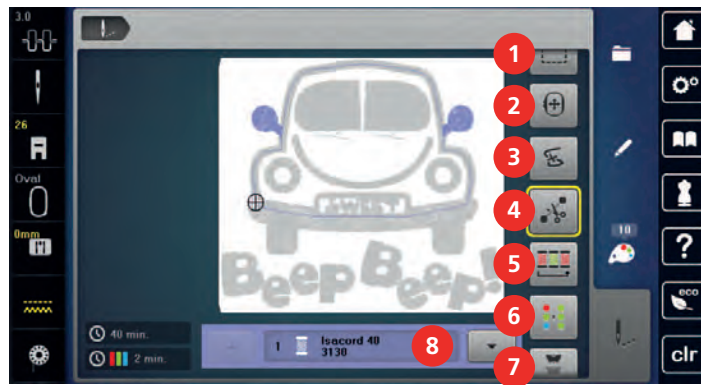

Overview Embroidery menu



- | | | | |
|---|--|---|---------------------------------------|
| 1 | Basting | 5 | Reducing color changes |
| 2 | Moving the hoop | 6 | Multi-colored embroidery motif on/off |
| 3 | Embroidery sequence control when thread breaks | 7 | Endless Embroidery |
| 4 | Cutting connecting stitches | 8 | Color indication |

Adding basting stitches

The basting stitches can be embroidered along the embroidery motif. Therefore the connection between the fabric and the stabilizer can be improved.

-  > Select an embroidery motif.
-  > Touch the icon «Embroidering».
-  > Touch the icon «Basting» to embroider basting stitches along the embroidery motif.
-  > Touch the icon «Basting» again to embroider basting stitches along the embroidery hoop.
-  > Touch the icon «Basting» again to deactivate the basting stitches.

Moving the hoop

If the embroidery motif is so big that repeated rehooping is necessary, the embroidered motif can be moved again.



- > Select an embroidery motif.
- > Touch the icon «Embroidering».



- > Touch the icon «Move the hoop».
- > Turn the «Upper Multifunctional knob» to move the hoop horizontally.
- > Turn the «Lower Multifunctional knob» to move the hoop vertically.



- > Touch the icon «Embroidering» in the process navigation to accept the settings.

Embroidery sequence control when thread breaks

When the thread breaks, the needle can be repositioned in the embroidery motif by means of the embroidery sequence control.



- > Select an embroidery motif.
- > Touch the icon «Embroidering».



- > Touch the icon «Embroidery sequence control when thread breaks».
 - In the left portion of the display a compact view of the embroidery motif is displayed. On the right side the enlarged embroidery motif is displayed.
- > Select the desired position in the compact view using the touchscreen pen/finger.
- > Turn the «Upper Multifunctional knob» to move the hoop stitch by stitch.
- > Turn the «Lower Multifunctional knob» to move the hoop in large steps.
 - The number in the yellow-framed icon indicates the number of stitches within the embroidery sequence.



- > Touch the icon «0-9» to select the desired stitch by entry.

Cutting connecting stitches

The function is activated by default and the connecting stitches are cut automatically. When the function is deactivated, the connecting stitches between the embroidery motifs must be cut manually.



- > Select an embroidery motif.
- > Touch the icon «Embroidering».



- > Touch the yellow-framed icon «Cut the connecting stitches» to deactivate the function.
- > Touch the yellow-framed icon «Cut the connecting stitches» again to activate the function.

Reducing color changes

When the embroidery motifs overlap, the color changes **cannot** be reduced.

- > Select an embroidery motif.



> Touch the icon «Embroidering».



> Touch the icon «Reduce thread change».
 – Identical colors of the embroidery motif are collected to one color.

Multi-colored embroidery motif on/off

Multi-colored embroidery motifs can also be embroidered in one color.



> Select an embroidery motif.
 > Touch the icon «Embroidering».



> Touch the icon «Multi-colored embroidery motif on/off».
 – The embroidery motif is embroidered in one color.

Endless Embroidery

Allows to resume embroidering borders which have already been started even if the machine has been switched off and on again.

Prerequisite:

- An embroidery motif for borders must be saved in the Personal Memory. The reference points must be defined in the embroidery motif.



> Select border embroidery motif from the Personal Memory.
 > Touch the icon «Embroidering».



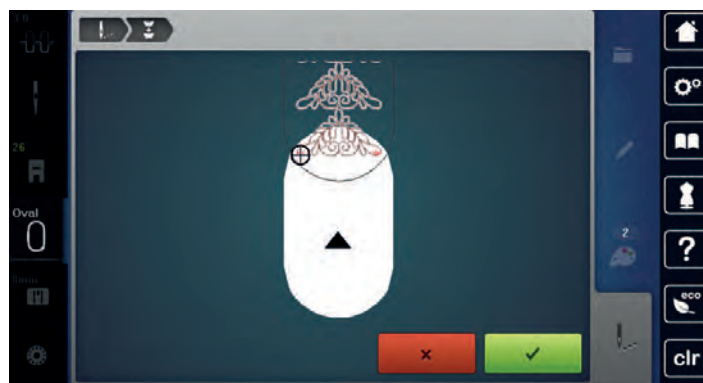

> The icon «Endless embroidery» becomes visible in the right bar by scrolling upwards.
 > Touch the icon «Endless Embroidery».

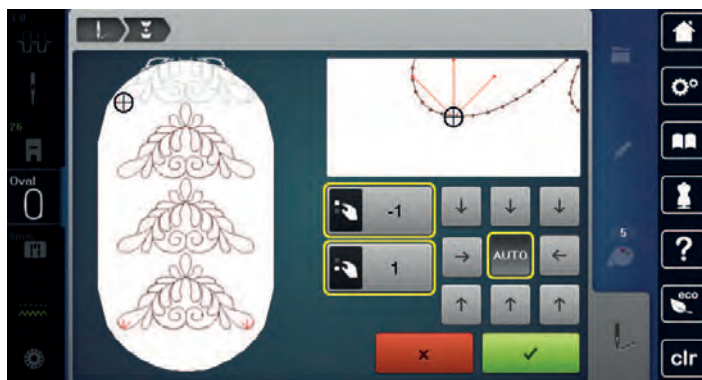

> Remove the hoop and rehoop the fabric so that the stitched out reference points are in the upper part of the embroidery area and at least 3 cm (1.18 inch) from the top edge of the hoop.
 > Attach the hoop.
 > Touch the icon «Confirm».
 – The hoop is moved automatically near the last stitch.
 – The icon «AUTO» is activated and the hoop moves automatically near the last reference point.

- > Via the arrow icons, determine on which side of the embroidered part the next reference point shall be placed.
- > Turn the «Upper Multifunctional knob» or the «Lower Multifunctional knob» to position the hoop exactly.



-  > Touch the icon «Confirm».
-  > Push the button «Start/Stop» and resume embroidering.
- > Repeat these steps until the desired length of the border is embroidered.

Color indication

Every color of the embroidery motif can be selected individually. The hoop moves to the first stitch of the current color. The currently active color can be embroidered individually or in another sequence.

- > Select an embroidery motif.
- > Touch the icon «Embroidering».



- > Touch the icon «Scroll down» to select the next color of the embroidery motif.



- > Touch the icon «Scroll up» to select the previous color of the embroidery motif.

15.11 Free arm embroidering

Free arm embroidering is defined as embroidering tubular fabrics or garments which are positioned around the free arm of the embroidery machine while being embroidered. Often used with sleeves, pant legs or other narrow-tailored garments.



A tubular piece of fabric can be pulled over the free arm of the machine easily when the free arm is positioned to the left in parking position before the hoop is attached or removed. Push the button «Start/Stop» to move the embroidery hoop back to the embroidery position again.

Make sure to use a full bobbin as the embroidery hoop needs to be removed for changing the bobbin.

Borders can be closed to a ring easily and exactly along the edge of the tube. Before embroidering the last embroidery motif, after rehooping the fabric, activate the function «Pinpoint placement» in the edit mode. Using the subfunction «Free point positioning» align the still missing embroidery motif precisely.

The movability of the embroidery arm can be limited or impeded with very narrow tubes. Therefore please make sure that the embroidery hoop can move forwards and backwards sufficiently. An impediment of the embroidery arm caused by a tube which is too tight can result in embroidery motif offset or in damaging the fabric.

Check the movability of the free arm

Please note: With tiny fabric tubes, deactivate the thread-away in the Setup Program if necessary.

- > Open the embroidery motif on the machine and edit as desired.
- > Mark the embroidery motif position and the size on the fabric in a suitable way.
- > Select the embroidery hoop as small as possible.
- > Hoop or stick the fabric along with the appropriate stabilizer in the embroidery hoop, depending on the stabilizer.
- > Pull the fabric tube carefully over the free arm of the machine and attach the embroidery hoop at the clutch of the embroidery module.
- > If necessary, reposition the embroidery motif.
- > Previously check whether the embroidery hoop can be moved forwards and backwards according to the embroidery motif size.
- > Touch the icon «Check embroidery motif size».
- > After the successful check of the embroidery motif size, start the embroidery process.

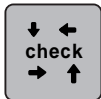

Detailed instructions about embroidery, the use of suitable materials or selecting the required embroidery settings of the machine can be found in the «Tutorial» under embroidery techniques --> Embroidering.

15.12 Administering embroidery motifs

Administering embroidery motifs



- | | | | |
|---|------------------------------|---|-----------------------------|
| 1 | Loading the embroidery motif | 3 | Saving the embroidery motif |
| 2 | Adding an embroidery motif | 4 | Deleting |

Saving embroidery motifs in the personal memory

In the filing system «Personal memory» any stitch patterns, also those which have been individually edited, can be saved.

- > Select an embroidery motif.
- > Edit the embroidery motif.
- > Touch the icon «Selection».



- > Touch the icon «Save the motif».
 - The embroidery motif to be saved is outlined in yellow.
 - The icon «Embroidery machine» is activated.



- > Touch the icon «Confirm».

Saving the embroidery motif on the BERNINA USB stick

- > Select an embroidery motif.
- > Edit the embroidery motif.
- > Touch the icon «Selection».



- > Touch the icon «Save the motif».
 - The embroidery motif to be saved is outlined in yellow.



- > Insert the BERNINA USB stick into the USB port of the machine.
- > Touch the icon «USB stick».



- > Touch the icon «Confirm».

Overwriting the embroidery motif in the personal memory

- > Select an embroidery motif.
- > Edit the embroidery motif.
- > Touch the icon «Selection».



- > Touch the icon «Save the motif».
 - The embroidery motif to be saved is outlined in yellow.



- Touch the icon «Embroidery machine» is activated.
- > Select the embroidery motif which is to be overwritten.



- > Touch the icon «Confirm».

Overwriting the embroidery motif on the BERNINA USB stick

- > Select an embroidery motif.
- > Edit the embroidery motif.
- > Touch the icon «Selection».



- > Touch the icon «Save the motif».
 - The embroidery motif to be saved is outlined in yellow.



- > Insert the BERNINA USB stick into the USB port of the machine.
- > Touch the icon «USB stick».
- > Select the embroidery motif which is to be overwritten.



- > Touch the icon «Confirm».

Importing stitch patterns

Stitch patterns or stitch pattern combinations can be imported from the Sewing mode to the Embroidery mode and edited like embroidery motifs. Therefore endless embroidery can be combined quickly and easily and saved as an embroidery motif in the file «Personal embroidery motifs».



> Touch the icon «Home».



> Touch the icon «Sewing mode».
> Select a stitch pattern.



> Touch the icon «Home».



> Touch the icon «Embroidery mode».
– The stitch pattern is saved automatically in the file «Personal embroidery motifs».



> Select the file «Personal embroidery motifs».
> Select an embroidery motif.

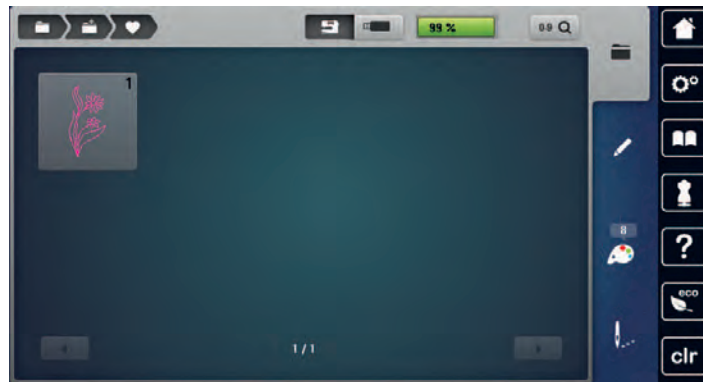

Loading an embroidery motif from the personal memory



> Touch the icon «Selection».



> Touch the icon «Upload embroidery motif».



> Select the file «Personal embroidery motifs».
> Select an embroidery motif.

Loading an embroidery motif from the BERNINA USB stick



> Touch the icon «Selection».
> Insert the BERNINA USB stick into the USB port of the machine.



> Touch the icon «USB stick».
> Select a personal embroidery motif.

Deleting an embroidery motif from the personal memory

The embroidery motifs which are saved in the personal memory can be deleted individually.



> Touch the icon «i»-Dialog.



> Touch the icon «Delete».



– Touch the icon «Embroidery machine» is activated.



> Select the embroidery motif which is to be deleted.



> Touch the icon «Confirm».

Deleting an embroidery motif from the BERNINA USB stick



> Touch the icon «Selection».



> Touch the icon «Delete».

> Insert the BERNINA USB stick into the USB port of the machine.



> Touch the icon «USB stick».

> Select the embroidery motif which is to be deleted.



> Touch the icon «Confirm».

16 Embroidery

16.1 Embroidering via the button «Start/Stop»

In case of a power cut the embroidery process is interrupted. After the restart the machine goes to the position which was embroidered last.



- > Push the button «Start/Stop» to start the embroidery machine.
 - All parts of the motif being in the current color are embroidered.
 - The embroidery machine stops automatically at the end.
 - Both threads are cut automatically.
 - The embroidery machine switches to the next color automatically.



- > Change the upper thread.
- > Push the button «Start/Stop» to embroider the new color.
- > After completing the embroidery motif, finish the embroidering process by touching the icon «Finishing the embroidering process» (1) or embroider the motif again by touching the icon «Endless embroidery»(2).



16.2 Increasing the embroidery speed

To ensure the best embroidery quality, the speed when embroidering is reduced depending on the embroidery position. Choose between the two options to either embroider at optimal or maximum speed. Standard = optimal speed. It has to be considered that the quality of the embroidered embroidery motif at maximum speed cannot be ensured.

By switching the machine off and on, the optimal embroidery speed is activated.

Prerequisite:

- The embroidery motif is selected.
- > Touch the icon «Embroidery speed».
 - The maximum speed is activated.
- > Touch the icon «Embroidery speed» again.
 - The optimal speed is activated.



16.3 Adjusting the upper thread tension

The basic setting of the upper thread tension is provided automatically as soon as a stitch pattern or an embroidery motif is selected.

When of using other types of sewing or embroidery threads, the optimal tension may vary. Therefore it may be necessary to adjust the upper thread tension according to the sewing or embroidering project as well as the desired stitch pattern or the embroidery motif individually.

The higher the upper thread tension, the tighter the upper thread which means that the bobbin thread is pulled up to the top of the fabric. When the upper thread tension is low, the upper thread is less tightened which means that the bobbin thread is pulled up less.

Alterations of the upper thread tension affect the currently selected stitch pattern or embroidery motif. Permanent alterations of the upper thread tension for the sewing mode (see page 57) and for the embroidering mode (see page 62) can be made in the Setup Program.

- > Touch the icon «Upper thread tension».
- > Move the slide using the touchscreen pen/finger to increase or reduce the upper thread tension.



- > Touch the yellow-framed icon on the right side to reset the alteration to default setting.
- > Touch the yellow-framed icon on the left side to reset the alteration to default setting in the **Setup Program**.

16.4 Embroidering via the foot control

Embroidering via the foot control is recommended when only a short sequence has to be embroidered. While embroidering, the foot control must be pressed down all the time.

- > Press the foot control to start embroidering.

17 Attachment

17.1 Maintenance and cleaning

Cleaning the display

- > Clean the display in the switched off status with a soft slightly damp microfiber cloth.

Cleaning the feed dog

Remove the thread remnants under the stitch plate regularly.



Electronically driven components

Risk of injury near the needle and the hook.

- > Raise the presser foot.
- > Switch the machine off and disconnect it from the power supply system.

- > Remove the presser foot and the needle.
- > Lower feed dog.



- > Remove the stitch plate.
- > Clean the feed dog with the brush.

Cleaning the hook



Electronically driven components

Risk of injury near the needle and the hook.

- > Switch the machine off and disconnect it from the power supply system.

- > Open the bobbin cover.
- > Remove the bobbin case.
- > Push the fastening bracket to the left.



- > Flap down the fastening bracket along with the black hook race cover.
- > Remove the hook.

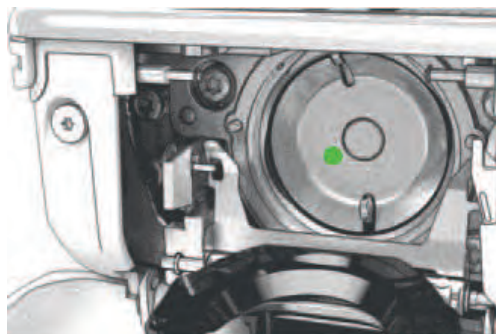

- > Clean the hook race area with the brush; never use a sharp instrument.
- > Hold the hook at the pin in the center with two fingers.
- > Lead the hook, lower edge ahead, angular top-down behind the hook race cover.
- > Position the hook with the two lugs meeting the openings in the hook, the colored mark on the hook driver should be visible through the hole in the hook.
- > Insert the hook.
 - The hook is magnetic and therefore fastened to the correct position.
- > Close the hook race cover and the fastening bracket until the release bracket engages.
- > As a check, turn the handwheel.
- > Insert the bobbin case.

Lubricating the hook



CAUTION

Electronically driven components

Risk of injury near the needle and the hook.

- > Switch the machine off and disconnect it from the power supply system.

NOTICE

Lubricating the hook

Too much oil can pollute the fabric and the thread.

- > Always sew a test sample first.
- > Remove the bobbin case.
- > Push the fastening bracket to the left.



- > Flap down the fastening bracket along with the black hook race cover.

- > Remove the hook.

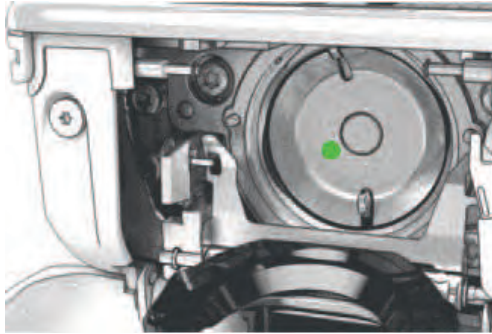

- > Give one drop of BERNINA oil down in the hook race.



- > Give one drop of oil in each of the two oil depots so that the felts are damp and make sure that the red-marked surface of the hook sleeve remains free of oil.



- > Hold the hook at the pin in the center with two fingers.
- > Lead the hook, lower edge ahead, angular top-down behind the hook race cover.
- > Position the hook with the two lugs meeting the openings in the hook, the colored mark on the hook driver should be visible through the hole in the hook.
- > Insert the hook.
 - The hook is magnetic and therefore fastened to the correct position.
- > Close the hook race cover and the fastening bracket until the release bracket engages.
- > As a check, turn the handwheel.
- > Insert the bobbin case.





17.2 Troubleshooting



Failure	Cause	Repair
Uneven stitch formation	Upper thread too tight or too loose.	> Adjust the upper thread tension.
	Needle blunt or bent.	> Replace the needle, make sure that a new BERNINA quality needle is used.
	Poor quality needle.	> Use a new BERNINA quality needle.
	Poor quality thread.	> Use quality thread.
	Incorrect needle/thread combination.	> Match the needle with the thread size.
	Incorrectly threaded.	> Rethread.
	The fabric has been pulled.	> Feed the fabric evenly.
Uneven stitch formation	Incorrect bobbin case is used.	> Use the supplied bobbin case marked with the triangle.
		
Skipped stitches	Incorrect needle.	> Use the needle system 130/705H.
	Needle blunt or bent.	> Replace the needle.
	Poor quality needle.	> Use a new BERNINA quality needle.
	The needle is incorrectly inserted.	> Insert the needle with the flat side to the back as far up as it will go into the needle holder and tighten the screw.
	Incorrect needle point.	> Match the needle point to the texture of the material.
Faulty stitching	Thread remnants between the thread tension discs.	> Fold a piece of thin material and slide the folded edge (not the raw edges) between the thread tension discs.
	Incorrectly threaded.	> Rethread.
	Thread remnants below the bobbin case spring.	> Remove the thread remnants under the spring.

Failure	Cause	Repair
Stitch width not adjustable	The selected needle and stitch plate cannot be used in combination.	<ul style="list-style-type: none"> > Replace the needle. > Replace the stitch plate.
Speed too low	Unfavorable room temperature.	> Place the machine in a warm room one hour before use.
	Settings in the Setup Program.	<ul style="list-style-type: none"> > Adjust the sewing speed in the Setup Program. > Adjust the slide.
The machine doesn't start	Unfavorable room temperature.	<ul style="list-style-type: none"> > Place the machine in a warm room one hour before use. > Connect the machine and switch it on.
	The machine is damaged.	> Contact the specialized BERNINA dealer.
The light of the button «Start-/Stop» doesn't light up	Light is defect.	> Contact the specialized BERNINA dealer.
Neither the sewing light nor the light on the free arm lights up	Settings in the Setup Program.	> Activate it in the Setup Program.
	The sewing light is defect.	> Contact the specialized BERNINA dealer.
Upper thread indicator doesn't react	Settings in the Setup Program.	> Activate it in the Setup Program.
	The upper thread indicator is defect.	> Contact the specialized BERNINA dealer.
Bobbin thread indicator doesn't react	Settings in the Setup Program.	> Activate it in the Setup Program.
	The bobbin thread indicator is defect.	> Contact the specialized BERNINA dealer.
Error during software update	USB stick is not recognized.	> Use a BERNINA USB stick.
	The update process is blocked and the hourglass on the display is inactive.	<ul style="list-style-type: none"> > Remove the USB stick. > Switch the machine off. > Switch the machine on. > Follow the instruction on the display.
	Date of the software update cannot be found.	<ul style="list-style-type: none"> > Unzip the update data. > Save data of the software update directly on the data medium and not in a file on the USB stick.

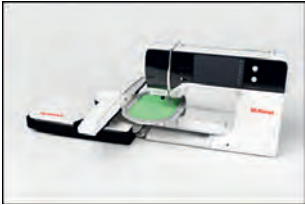
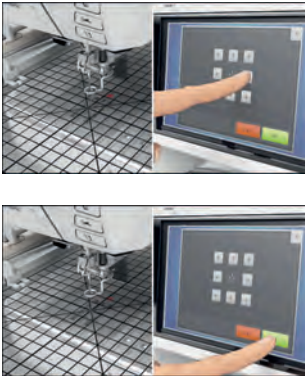
17.3 Error messages

Message on the display	Cause	Repair
	Stitch number unknown.	> Check the entry and enter the new number.
	Selection of the stitch pattern not possible in the combi mode.	> Combine other stitches.
	The feed dog is not lowered.	> Push the button «Feed dog up/down» to lower the feed dog.
	The selected needle and stitch plate cannot be used in combination.	> Replace the needle. > Replace the stitch plate.
	The needle is not at its top end.	> Adjust the needle position via the handwheel.
	The upper thread is used up.	> Rethread.
	The upper thread has broken.	> Rethread.
	The bobbin thread is used up.	> Rethread.
	The bobbin thread has broken.	> Clean the hook. > Rethread.

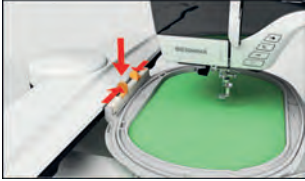
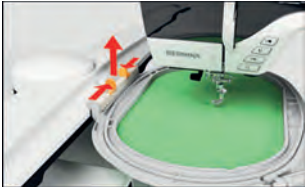
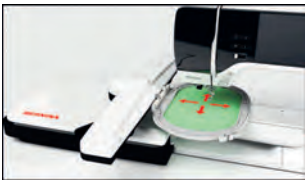
Message on the display	Cause	Repair
	The main motor isn't running.	<ul style="list-style-type: none"> > Turn the handwheel clockwise until the needle is at its top position. > Remove the stitch plate. > Remove the thread remnants. > Clean the hook. > Remove the hook and make sure that there are no pieces of broken needle points on the magnetic back of the hook.
	Incorrect presser foot for the BERNINA Dual Feed.	<ul style="list-style-type: none"> > Attach a presser foot with the designation «D».
	The fabric under the presser foot is too thick.	<ul style="list-style-type: none"> > Reduce the fabric thickness.
	The contact between the machine and the embroidery module is interrupted due to vibrations.	<ul style="list-style-type: none"> > Make sure that the module and the machine are standing on a stable, even surface. > Connect the embroidery module to the machine.
	The needle position doesn't correspond with the center of the hoop.	<ul style="list-style-type: none"> > Calibrate the hoop.
	The embroidery module is not attached.	<ul style="list-style-type: none"> > Connect the embroidery module to the machine. > Contact the specialized BERNINA dealer to have the machine checked.

Message on the display	Cause	Repair
	The hoop is not attached.	> Attach the hoop.
	The hoop is attached.	> Remove the hoop.
	The movement of the hoop follows.	> Touch the icon «Confirm».
	The embroidery motif is partly outside the hoop.	> Reposition the embroidery motif and start embroidering it again.
	The embroidery motif is too large.	> Reduce the size of the embroidery motif. > Attach a larger hoop.
Too less free capacity on the BERNINA USB stick (optional accessory).	Not enough free capacity on the BERNINA USB stick (optional accessory).	> Make sure that the BERNINA USB stick (optional accessory) is used. > Delete data from the BERNINA USB stick (optional accessory).
No personal data on the BERNINA USB stick (optional accessory).	No personal data for recovery available on the BERNINA USB stick (optional accessory).	> Make sure that the data and settings have been saved on the BERNINA USB stick (optional accessory).
The recovery of personal data has failed.	The software update has been successful but the personal data couldn't be recovered.	> Make sure that the data and settings have been saved on the BERNINA USB stick (optional accessory). > Transfer saved data to the machine.

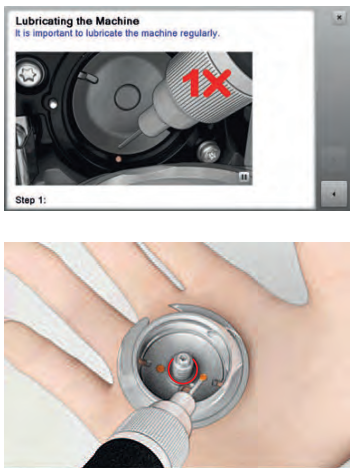
Message on the display	Cause	Repair
No BERNINA USB stick is inserted. Make sure that during the complete automatic update always the same BERNINA USB stick remains inserted.	The BERNINA USB stick (optional accessory) is not inserted.	> Use a BERNINA USB stick (optional accessory) providing enough free capacity.
The update of the software has failed.	The latest software version cannot be found on the USB stick.	> Make sure that the compressed zip file has been unzipped for the software update. > Check whether the data for the software update are saved directly on the data medium and not in a file on the USB stick. > Update the software.
	The machine needs cleaning/ lubricating.	> Clean the machine. > Lubricate the machine. Important information on lubricating: > Too much oil can pollute the fabric and the thread. > After lubricating, embroider a test piece first.
The automatic thread cutter (at the thread catcher) needs cleaning.	The automatic thread cutter needs cleaning. The message appears every time when the machine is started as soon as 1000 cutting cycles have been carried out.	> Touch the icon «Confirm». – The machine calls up the function «Clean the thread catcher». > Clean the thread catcher according to the instructions on the display. – The counter for the cutting cycles is reset.

17.5 Technical data

Term	Value	Unit
Maximum fabric thickness	12,5 (0,49)	mm (in)
Sewing light	30	LED
Maximum speed	1000	Stitches per minute
Measurements without the spool pin (W × H × D)	522 × 358 × 214 (20,55 × 14,09 × 8,43)	mm (in)
Weight	14 (30,86)	kg (lb)
Energy consumption	140	W
Input voltage	100 – 240	V
Protection class (Electrical engineering)	II	

18 Overview stitch patterns

18.1 Overview Stitch patterns

Practical stitches

1	2	3	4	5	6	7	8	9	10	11
12	13	14	15	16	17	18	19	20	21	22
23	24	25	26	27	29	31	32	33	34	

Buttonholes

51	52	53	54	55	56	57	58	59	63	66
68	69	60	61	62						

Decorative stitches

Floral stitches

101	102	103	104	107	108	110	111	112	113	114
115	117	119	122	123	124	125	129	133	134	136
137	140	141	143	144	145	146	147	148	150	152

156	158	159	160	170	171					

Florals sideways motion

201	204	206	207	212	230	231	232	233	234	235
236	237	238	239	240	242	243	244	245	246	247
248	249	250	251	252	257					

Cross stitches

301	302	303	304	305	306	307	308	309	311	313
314	316	317	321	322	323	324	325	326	327	328
332	333	334	335	336	337	338	339	371	372	373
374	375	376	377							

Satin stitches

401	402	405	406	407	408	412	413	414	415	416
417	419	422	423	424	425	426	427	428	429	430

431	434	437	439	441	443	444	445	446	447	448
450	451	457	458	461	464	465	466	467	468	469
470	471	473								

Satin stitches sideways motion

501	502	505	506	507	508	509	510	511	512	513
514	517	518	519	520	523	524	525			

Ornamental stitches

601	602	603	604	605	606	607	608	609	610	611
612	613	614	615	616	618	619	621	622	623	624
625	626	627	628	629	630	631	633	635	636	637
639	640	641	642	643	644	646	648	649	651	652
653	654	655	656	657	658	660	661	662	663	664

665	666	671	672	674	675	676	677	679	680	681
682	683	684	685	686	690	692	696			

Heirloom stitches

701	702	704	705	706	707	708	709	710	711	712
713	714	717	718	719	720	721	722	723	724	725
726	727	728	730	731	732	734	735	736	737	738
739	740	741	742	743	745	746	747	748	749	750
751	753	756	757	761	763	765	767	769	770	777
779	780	781								

Heirloom sideways motion

801	802	827	828	829	830	833	834	835	840	841

Novelty

902	903	904	906	910	913	914	916	919	920	921

930	933	934	935	936	937	938	939	940	941	942
943	944	945	946	947	948					

Novelty sideways motion

1001	1002	1003	1004	1005	1006	1007	1008			

Filigree Stitches sideways motion

1201	1202	1203	1204	1205	1206	1207	1208	1209	1210	1211
1212	1213	1215	1216	1217	1218	1220	1221			

Quilt stitches

1324	1325	1326	1327	1328	1329	1330	1331	1332	1333	1334
1335	1337	1338	1339	1340	1341	1342	1343	1344	1345	1347
1348	1350	1351	1352	1353	1354	1355	1356	1357	1358	1359
1395	1396	1397	1398							

Tapering Stitches

1401	1402	1403	1404	1405	1406	1409	1411	1412	1413	1414
1415	1416	1417	1418	1419	1420	1422	1423	1424	1430	1431
1446	1447	1448	1450	1460	1462					

Skyline Stitches (special stitches)

1501	1502	1503	1504	1505	1507	1508	1509	1510	1511	1512
1513	1514	1515	1516	1517	1518	1519	1520	1521	1522	1524
1526	1527									

Quilt stitches sideways motion

1601	1602	1603	1604	1605	1606	1607	1608	1609	1610	1611
1612	1613	1614	1615	1616	1617	1618	1619	1620	1629	1630
1631	1632	1633	1634	1635	1636	1637	1638	1639	1660	

International

1701	1702	1703	1704	1705	1706	1707	1708	1709	1710	1711

1715	1716	1717	1718	1719	1720	1721	1722	1723		

18.2 Overview Embroidery motifs

Editing embroidery motifs

Let your inspiration run free. A vast selection of embroidery motifs is at your disposal.

If you see one of the following pictograms below a number of the embroidery motif, you can find additional information at

www.bernina.com/7series.

	Detached point		Punchwork Design (motif)
	Hole embroidery		Cord embroidery
	Fringe embroidery		Projects in the hoop
	Appliqué		Puffy fonts
	CutWork Design (motif)		Quilting
	PaintWork Design (motif)		Trapunto
	CrystalWork Design (motif)		







Embellishment





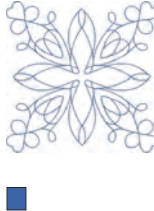

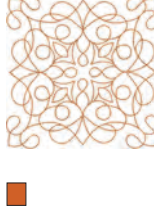

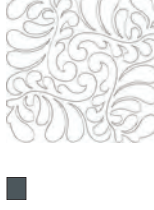



No.	Embroidery motif Colors	Width × height • mm • (in)	No.	Embroidery motif Colors	Width × height • mm • (in)
BE790501	 	199 × 276 (7.9 × 10.9)	21008-15	 	119 × 120 (4.7 × 4.7)





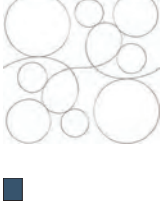



No.	Embroidery motif Colors	Width × height • mm • (in)	No.	Embroidery motif Colors	Width × height • mm • (in)
82006-30 	 	100 × 174 (3.9 × 6.9)	BE790503	 	130 × 130 (5.1 × 5.2)
BE790504	 	121 × 121 (4.8 × 4.8)	FB126	 	87 × 102 (3.4 × 4.0)
82005-01 	 	175 × 109 (6.9 × 4.3)	21003-26 	 	123 × 124 (4.8 × 4.9)
82006-36 	 	121 × 123 (4.8 × 4.8)	BE790403	 	140 × 130 (5.5 × 5.1)
NB018	 	90 × 97 (3.6 × 3.8)	NB728	 	97 × 112 (3.8 × 4.4)
NB403	 	78 × 78 (3.1 × 3.1)	HG079	 	116 × 116 (4.6 × 4.6)

No.	Embroidery motif Colors	Width × height • mm • (in)	No.	Embroidery motif Colors	Width × height • mm • (in)
FB433	 ■ ■ ■	121 × 121 (4.8 × 4.8)			

































Quilt motifs



























No.	Embroidery motif Colors	Width × height • mm • (in)	No.	Embroidery motif Colors	Width × height • mm • (in)
BD289	 ■	201 × 201 (7.9 × 7.9)	BD285	 ■	202 × 201 (8.0 × 7.9)
BD288	 ■	202 × 201 (8.0 × 7.9)	BD292	 ■	94 × 95 (3.7 × 3.7)
BD299	 ■	94 × 95 (3.7 × 3.7)	BD308	 ■	95 × 94 (3.7 × 3.7)
BD413	 ■	97 × 97 (3.8 × 3.8)	BD837	 ■	123 × 123 (4.9 × 4.9)



















No.	Embroidery motif Colors	Width × height • mm • (in)	No.	Embroidery motif Colors	Width × height • mm • (in)
12380-43		123 × 123 (4.9 × 4.9)	12380-30		89 × 96 (3.5 × 3.8)
12380-04		83 × 89 (3.3 × 3.5)	12380-08		89 × 89 (3.5 × 3.5)
12380-09		111 × 61 (4.4 × 2.4)	12380-22		110 × 60 (4.4 × 2.4)
12380-10		152 × 356 (6.0 × 14.0)	BD796		47 × 174 (1.9 × 6.9)
BD800		127 × 122 (5.0 × 4.8)	BD801		122 × 124 (4.8 × 4.9)
BD804		122 × 123 (4.8 × 4.9)	BD394		97 × 96 (3.8 × 3.8)

No.	Embroidery motif Colors	Width × height • mm • (in)	No.	Embroidery motif Colors	Width × height • mm • (in)
BD412		89 × 53 (3.5 × 2.1)	BD513		63 × 63 (2.5 × 2.5)
BD514		63 × 63 (2.5 × 2.5)	BD553		113 × 121 (4.5 × 4.8)
BD567		108 × 108 (4.3 × 4.3)	BD554		110 × 109 (4.3 × 4.3)
BD659		66 × 219 (2.6 × 8.6)	BD665		160 × 117 (6.3 × 4.6)
HE959		120 × 120 (4.8 × 4.8)			





















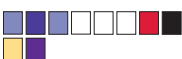







Borders and Lace

























No.	Embroidery motif Colors	Width × height • mm • (in)	No.	Embroidery motif Colors	Width × height • mm • (in)
NB952 	 	108 × 119 (4.3 × 4.7)	OC00303 	 	100 × 110 (4.0 × 4.4)
12410-08 	 	80 × 168 (3.2 × 6.6)	12410-07 	 	115 × 158 (4.5 × 6.2)
12410-15 	 	29 × 133 (1.1 × 5.3)	12454-05 	 	117 × 108 (4.6 × 4.3)
12454-06 	 	116 × 47 (4.6 × 1.9)	12454-07 	 	48 × 57 (1.9 × 2.3)
FA981	 	35 × 142 (1.4 × 5.6)	BE790701	 	113 × 230 (4.5 × 9.1)
BE790704	 	72 × 217 (2.9 × 8.6)	BE790703	 	70 × 186 (2.8 × 7.3)

No.	Embroidery motif Colors	Width × height • mm • (in)	No.	Embroidery motif Colors	Width × height • mm • (in)
BE790702	 	73 × 190 (2.9 × 7.5)	21013-29	 	40 × 152 (1.6 × 6.0)
21013-30	 	75 × 75 (3.0 × 3.0)	12398-29 	 	26 × 153 (1.0 × 6.0)
12398-30 	 	76 × 76 (3.0 × 3.0)	OC33411	 	24 × 177 (1.0 × 7.0)
CM471 	 	59 × 190 (2.3 × 7.5)	FB403	 	52 × 208 (2.1 × 8.2)
FQ785	 	92 × 342 (3.6 × 13.5)	FQ969	 	51 × 162 (2.0 × 6.4)
FQ408	 	30 × 97 (1.2 × 3.8)	FQ736	 	8 × 253 (0.3 × 10.0)



























No.	Embroidery motif Colors	Width × height • mm • (in)	No.	Embroidery motif Colors	Width × height • mm • (in)
BD582	 	48 × 171 (1.9 × 6.7)	NA912	 	15 × 115 (0.62 × 4.5)
NA914	 	18 × 120 (0.7 × 4.7)	NB478	 	121 × 85 (4.8 × 3.4)
FQ847	 	142 × 150 (5.6 × 5.9)	FQ945	 	93 × 95 (3.7 × 3.7)
FQ041	 	54 × 78 (2.1 × 3.1)	FB422	 	52 × 33 (2.1 × 1.3)
FB423	 	132 × 53 (5.2 × 2.1)			









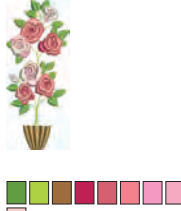
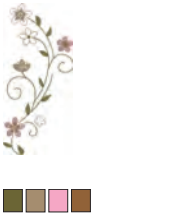

Children











No.	Embroidery motif Colors	Width × height • mm • (in)	No.	Embroidery motif Colors	Width × height • mm • (in)
BE790305 	 	118 × 145 (4.7 × 5.7)	BE790302	 	68 × 66 (2.7 × 2.6)
BE790303	 	69 × 70 (2.7 × 2.8)	BE790304	 	127 × 65 (5.0 × 2.6)
BE790307 	 	141 × 127 (5.6 × 5.0)	BE790308 	 	191 × 219 (7.5 × 8.6)
12421-03	 	45 × 48 (1.8 × 1.9)	NB193	 	113 × 96 (4.5 × 3.8)
CM384	 	77 × 80 (3.1 × 3.2)	CM226 	 	63 × 63 (2.5 × 2.5)
CM193 	 	106 × 127 (4.2 × 5.0)	CM220 	 	71 × 71 (2.8 × 2.8)

No.	Embroidery motif Colors	Width × height • mm • (in)	No.	Embroidery motif Colors	Width × height • mm • (in)
WP325	 	77 × 94 (3.1 × 3.7)	CM428	 	78 × 106 (3.1 × 4.2)
CM404	 	47 × 165 (1.9 × 6.5)	CM368	 	70 × 140 (2.8 × 5.5)
CM147	 	55 × 99 (2.2 × 3.9)	CM022	 	89 × 97 (3.5 × 3.8)
CM442	 	46 × 47 (1.8 × 1.9)	CM362	 	120 × 113 (4.8 × 4.5)
WP201	 	76 × 92 (3.0 × 3.6)	CM286	 	97 × 82 (3.9 × 3.2)
CK970	 	84 × 81 (3.3 × 3.2)	RC765	 	100 × 99 (4.0 × 3.9)

























Flowers







No.	Embroidery motif Colors	Width × height • mm • (in)	No.	Embroidery motif Colors	Width × height • mm • (in)
80001-23	 	85 × 101 (3.4 × 4.0)	BE790404	 	202 × 225 (8.0 × 8.9)
12392-1 	 	112 × 157 (4.4 × 6.2)	12392-13	 	112 × 203 (4.4 × 8.0)
12457-13	 	113 × 130 (4.5 × 5.1)	12457-06	 	106 × 172 (4.2 × 6.8)
BE790401	 	205 × 242 (8.1 × 9.5)	BE790405	 	125 × 185 (5.0 × 7.3)
FS142	 	69 × 143 (2.7 × 5.7)	82004-34 	 	198 × 281 (7.8 × 11.1)
BE790409	 	188 × 215 (7.4 × 8.5)	BE790402	 	146 × 280 (5.8 × 11.0)



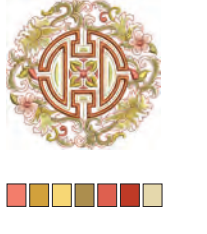
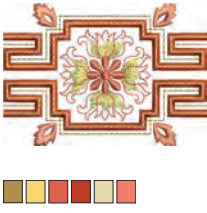

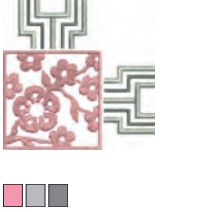
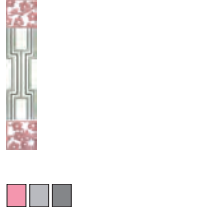

No.	Embroidery motif Colors	Width × height • mm • (in)	No.	Embroidery motif Colors	Width × height • mm • (in)
FQ061		75 × 92 (3.0 × 3.7)	FQ801		46 × 112 (1.8 × 4.4)
FQ273		88 × 193 (3.5 × 7.6)	FQ055		84 × 100 (3.3 × 4.0)
FQ982		150 × 218 (5.9 × 8.6)	FB268		123 × 87 (4.9 × 3.4)
FQ934		119 × 192 (4.7 × 7.6)	CM418		45 × 87 (1.8 × 3.4)
FQ972		111 × 73 (4.4 × 2.9)	FQ548		93 × 159 (3.7 × 6.3)
NB513		103 × 111 (4.1 × 4.4)	FQ274		63 × 77 (2.5 × 3.1)

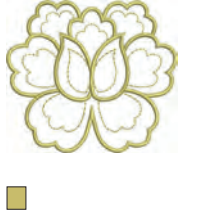
No.	Embroidery motif Colors	Width × height • mm • (in)	No.	Embroidery motif Colors	Width × height • mm • (in)
NB668	 ■ ■ ■	114 × 165 (4.5 × 6.5)	FQ331	 ■ ■ ■ ■ ■	84 × 63 (3.3 × 2.5)
FQ738	 ■ ■ ■ ■	51 × 101 (2.0 × 4.0)	FQ434	 ■ ■ ■	100 × 162 (3.9 × 6.4)
FB419	 ■ ■	64 × 56 (2.5 × 2.2)	WS673	 ■ ■	67 × 170 (2.7 × 6.7)
FQ108	 ■ ■ ■	119 × 136 (4.7 × 5.4)	FQ161	 ■	128 × 170 (5.1 × 6.7)
NB442	 ■ ■ ■	55 × 58 (2.2 × 2.3)	FA971	 ■	115 × 106 (4.5 × 4.2)









Seasons



































No.	Embroidery motif Colors	Width × height • mm • (in)	No.	Embroidery motif Colors	Width × height • mm • (in)
12384-02	 	132 × 203 (5.2 × 8.0)	12384-11	 	84 × 189 (3.3 × 7.5)
12443-03	 	120 × 161 (4.7 × 6.4)	12443-11	 	73 × 193 (2.9 × 7.6)
12427-01	 	133 × 167 (5.3 × 6.6)	12427-11	 	81 × 126 (3.2 × 5.0)
12400-03	 	123 × 161 (4.9 × 6.4)	12400-11	 	74 × 212 (2.9 × 8.3)
HG319	 	88 × 151 (3.5 × 6.0)	HG301	 	124 × 122 (4.9 × 4.8)
BD603	 	80 × 78 (3.2 × 3.1)	HE919	 	89 × 69 (3.5 × 2.7)





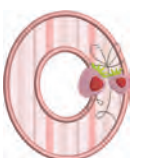











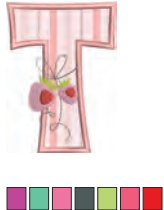

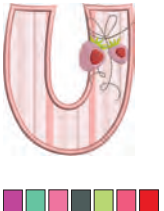
No.	Embroidery motif Colors	Width × height • mm • (in)	No.	Embroidery motif Colors	Width × height • mm • (in)
FB492		86 × 293 (3.4 × 11.5)	FQ194		120 × 118 (4.7 × 4.7)
FQ217		84 × 59 (3.2 × 2.3)	FA427		111 × 66 (4.4 × 2.6)
FB276		124 × 112 (4.9 × 4.4)	FB283		102 × 109 (4.0 × 4.3)
FB490		67 × 67 (2.7 × 2.7)	FB491		31 × 165 (1.3 × 6.5)
NB491		79 × 168 (3.1 × 6.6)	FB484		66 × 59 (2.6 × 2.3)

No.	Embroidery motif Colors	Width × height • mm • (in)	No.	Embroidery motif Colors	Width × height • mm • (in)
SP266	 Red, Blue	75 × 54 (3.0 × 2.1)	SP989	 Grey, Blue, Yellow, Black	101 × 82 (4.0 × 3.2)
SR067	 Blue, Orange, Green, Yellow, Black	87 × 96 (3.5 × 3.8)	LT870	 White, Grey, Red, Brown, Black, Pink	97 × 57 (3.8 × 2.2)
SR589	 Grey, Orange, Blue, Red, White, Black	95 × 66 (3.8 × 2.6)	FB158	 Brown, Pink, Grey	39 × 53 (1.6 × 2.1)































Monograms in pink































No.	Embroidery motif Colors	Width × height • mm • (in)	No.	Embroidery motif Colors	Width × height • mm • (in)
BE790101 	 Purple, Green, Pink, Black, Red	75 × 89 (3.0 × 3.5)	BE790102 	 Purple, Green, Pink, Black, Red	73 × 89 (2.9 × 3.5)
BE790103 	 Purple, Green, Pink, Black, Red	64 × 92 (2.5 × 3.7)	BE790104 	 Purple, Green, Pink, Black, Red	90 × 97 (3.6 × 3.8)



















No.	Embroidery motif Colors	Width × height • mm • (in)	No.	Embroidery motif Colors	Width × height • mm • (in)
BE790105 	 	61 × 89 (2.4 × 3.5)	BE790106 	 	63 × 90 (2.5 × 3.5)
BE790107 	 	79 × 90 (3.1 × 3.5)	BE790108 	 	70 × 90 (2.8 × 3.5)
BE790109 	 	32 × 100 (1.3 × 4.0)	BE790110 	 	73 × 89 (2.9 × 3.5)
BE790111 	 	65 × 89 (2.6 × 3.5)	BE790112 	 	70 × 89 (2.8 × 3.5)
BE790113 	 	88 × 90 (3.5 × 3.6)	BE790114 	 	76 × 90 (3.0 × 3.6)
BE790115 	 	74 × 89 (2.9 × 3.5)	BE790116 	 	71 × 103 (2.8 × 4.1)

No.	Embroidery motif Colors	Width × height • mm • (in)	No.	Embroidery motif Colors	Width × height • mm • (in)
BE790117 		82 × 100 (3.2 × 4.0)	BE790118 		73 × 103 (2.9 × 4.1)
BE790119 		60 × 89 (2.4 × 3.5)	BE790120 		71 × 99 (2.8 × 3.9)
BE790121 		77 × 89 (3.1 × 3.5)	BE790122 		86 × 89 (3.4 × 3.5)
BE790123 		104 × 89 (4.1 × 3.5)	BE790124 		90 × 92 (3.6 × 3.6)
BE790125 		84 × 89 (3.3 × 3.5)	BE790126 		56 × 89 (2.2 × 3.5)









Monograms in blue

















No.	Embroidery motif Colors	Width × height • mm • (in)	No.	Embroidery motif Colors	Width × height • mm • (in)
BE790201 	 	85 × 95 (3.3 × 3.8)	BE790202 	 	79 × 95 (3.1 × 3.8)
BE790203 	 	78 × 95 (3.1 × 3.8)	BE790204 	 	104 × 96 (4.1 × 3.8)
BE790205 	 	83 × 95 (3.3 × 3.8)	BE790206 	 	77 × 96 (3.1 × 3.8)
BE790207 	 	92 × 95 (3.7 × 3.8)	BE790208 	 	87 × 95 (3.5 × 3.8)
BE790209 	 	51 × 111 (2.0 × 4.4)	BE790210 	 	88 × 95 (3.5 × 3.8)

No.	Embroidery motif Colors	Width × height • mm • (in)	No.	Embroidery motif Colors	Width × height • mm • (in)
BE790211 	 	75 × 95 (3.0 × 3.8)	BE790212 	 	83 × 95 (3.3 × 3.8)
BE790213 	 	99 × 101 (3.9 × 4.0)	BE790214 	 	89 × 94 (3.5 × 3.7)
BE790215 	 	88 × 95 (3.5 × 3.8)	BE790216 	 	71 × 95 (2.8 × 3.7)
BE790217 	 	86 × 102 (3.4 × 4.0)	BE790218 	 	82 × 95 (3.3 × 3.7)
BE790219 	 	79 × 95 (3.1 × 3.8)	BE790220 	 	69 × 95 (2.7 × 3.8)



No.	Embroidery motif Colors	Width × height • mm • (in)	No.	Embroidery motif Colors	Width × height • mm • (in)
BE790221 	 	90 × 95 (3.5 × 3.8)	BE790222 	 	93 × 95 (3.7 × 3.8)
BE790223 	 	114 × 95 (4.5 × 3.8)	BE790224 	 	93 × 95 (3.7 × 3.8)
BE790225 	 	89 × 95 (3.5 × 3.8)	BE790226 	 	59 × 96 (2.3 × 3.8)







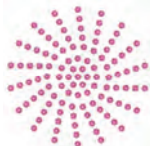

















Animals

No.	Embroidery motif Colors	Width × height • mm • (in)	No.	Embroidery motif Colors	Width × height • mm • (in)
CM140	 	88 × 97 (3.5 × 3.9)	CM142	 	56 × 66 (2.2 × 2.6)
FB258	 	83 × 184 (3.3 × 7.2)	FQ106	 	109 × 109 (4.3 × 4.3)













No.	Embroidery motif Colors	Width × height • mm • (in)	No.	Embroidery motif Colors	Width × height • mm • (in)
FQ617	 	118 × 198 (4.6 × 7.8)	FQ624	 	64 × 144 (2.5 × 5.7)
MT022	 	123 × 125 (4.9 × 4.9)	MT028	 	103 × 93 (4.1 × 3.7)
WM785	 	84 × 103 (3.3 × 4.1)	WP217	 	93 × 78 (3.7 × 3.1)
WP244	 	136 × 172 (5.4 × 6.8)	WS610	 	127 × 111 (5.0 × 4.4)

DesignWorks design





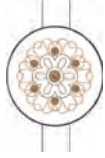







No.	Embroidery motif Colors	Width × height • mm • (in)	No.	Embroidery motif Colors	Width × height • mm • (in)
DW11 		70 × 71 (2.8 × 2.8)	BE790901 		252 × 181 (9.9 × 7.9)













No.	Embroidery motif Colors	Width × height • mm • (in)	No.	Embroidery motif Colors	Width × height • mm • (in)
BE790903 		181 × 292 (7.1 × 11.5)	BE790905 		104 × 227 (4.1 × 8.9)
BE790906 		192 × 195 (7.6 × 7.7)	BE790909 		167 × 322 (6.6 × 12.7)
DW07 		114 × 152 (4.5 × 6.0)	DW05 		105 × 94 (4.2 × 3.7)
DW10 		184 × 184 (7.3 × 7.3)	DW08 		206 × 100 (8.1 × 4.0)
BE700121 		196 × 197 (7.8 × 7.8)	BE700122 		119 × 37 (4.7 × 1.5)
BE700123 		112 × 205 (4.4 × 8.1)	BE700124 		141 × 134 (5.6 × 5.3)













Projects







No.	Embroidery motif Colors	Width × height • mm • (in)	No.	Embroidery motif Colors	Width × height • mm • (in)
BE700701 	 	208 × 201 (8.2 × 7.9)	12604-02 	 	45 × 152 (1.8 × 6.0)
21519-03 	 	108 × 161 (4.3 × 6.4)	19999-03 2 	 	90 × 143 (3.6 × 5.6)

Charming Monograms









No.	Embroidery motif Colors	Width × height • mm • (in)	No.	Embroidery motif Colors	Width × height • mm • (in)
12587-01 		58 × 89 (2.3 × 3.5)	12587-02 		52 × 89 (2.1 × 3.5)
12587-03 		45 × 89 (1.8 × 3.5)	12587-04 		56 × 90 (2.2 × 3.6)
12587-05 		50 × 90 (2.0 × 3.6)	12587-06 		57 × 89 (2.2 × 3.5)

No.	Embroidery motif Colors	Width × height • mm • (in)	No.	Embroidery motif Colors	Width × height • mm • (in)
12587-07	 □	39 × 90 (1.5 × 3.6)	12587-08	 □	62 × 90 (2.4 × 3.6)
12587-09	 □	49 × 89 (1.9 × 3.5)	12587-10	 □	57 × 89 (2.2 × 3.5)
12587-11	 □	61 × 90 (2.4 × 3.6)	12587-12	 □	63 × 90 (2.5 × 3.5)
12587-13	 □	64 × 92 (2.5 × 3.6)	12587-14	 □	63 × 90 (2.5 × 3.6)
12587-15	 □	44 × 90 (1.8 × 3.6)	12587-16	 □	63 × 89 (2.5 × 3.5)
12587-17	 □	54 × 89 (2.1 × 3.5)	12587-18	 □	64 × 90 (2.5 × 3.6)

No.	Embroidery motif Colors	Width × height • mm • (in)	No.	Embroidery motif Colors	Width × height • mm • (in)
12587-19	 □	56 × 90 (2.2 × 3.6)	12587-20	 □	57 × 89 (2.2 × 3.5)
12587-21	 □	62 × 91 (2.4 × 3.6)	12587-22	 □	64 × 91 (2.5 × 3.6)
12587-23	 □	64 × 90 (2.5 × 3.6)	12587-24	 □	62 × 90 (2.5 × 3.6)
12587-25	 □	51 × 91 (2.5 × 3.6)	12587-26	 □	67 × 89 (2.7 × 3.5)
12587-53	 □	67 × 22 (2.7 × 0.9)	12587-54	 □	50 × 106 (2.0 × 4.2)
12587-55	 □	70 × 144 (2.8 × 5.7)	12587-56	 □	49 × 100 (1.9 × 3.9)





No.	Embroidery motif Colors	Width × height • mm • (in)	No.	Embroidery motif Colors	Width × height • mm • (in)
12587-57	 □	57 × 20 (2.3 × 0.8)	12587-58	 □	52 × 116 (2.1 × 4.6)
12587-59	 □	33 × 94 (1.3 × 3.7)	12587-60	 □	126 × 126 (5.0 × 5.0)
12587-61	 □	35 × 28 (1.4 × 1.1)	12587-62	 □	35 × 33 (1.4 × 1.3)

Homedeco

No.	Embroidery motif Colors	Width × height • mm • (in)	No.	Embroidery motif Colors	Width × height • mm • (in)
12535-03	 	160 × 120 (6.3 × 4.7)	82011-30	 	107 × 130 (4.2 × 5.1)
82011-28	 	133 × 99 (5.3 × 3.9)	82006-02	 	128 × 205 (5.1 × 8.1)



Overview stitch patterns

No.	Embroidery motif Colors	Width × height • mm • (in)	No.	Embroidery motif Colors	Width × height • mm • (in)
21027-16	 	57 × 152 (2.3 × 6.0)	21027-17	 	57 × 151 (2.3 × 6.0)

Overview Embroidery motifs	215
Overview Stitch patterns	209

P

Pintucks	124
Placing the spool disc	40
Positioning of grid points	178
Power save mode	77
Practical stitches	102
Programming the securing stitches	57

Q

Quilting	141
----------	-----

R

Raising/Lowering the needle	39
Registering details of the dealer	74
Regulating the speed	80, 168

S

Safety instructions	16
Saving Service data	75
Selecting a language	68
Selecting a stitch pattern	78
Selecting personal settings	66
Selecting the embroidery motif	157
Sewing a test sample	134
Stitch Designer	95
Storing the machine	207

T

Tapering	121
Technical data	208
Threading the bobbin thread	54
Threading the double needle	51
Threading the triple needle	52
Threading the upper thread	49

U

Updating the machine Firmware	71
Upgrade	76
Using a spool net	41
Using eco mode	77

V

Virtual positioning of the embroidery hoop	166
--	-----

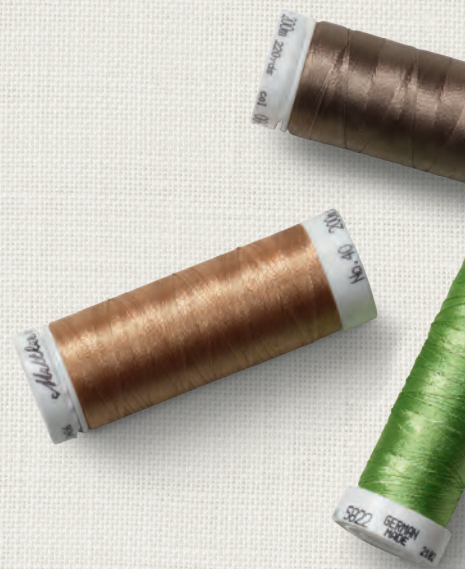

in partnership with

Mettler

made to create **BERNINA**